

fündekals :)

F-4B/C/D/E/J

RF-4B/C/E

1 1
AN/ASA-32 G LIMIT ACC
AMCS AERO TA
AN/AJB-3A FLT DIR SIG A
EXTERNAL LIGHTS FLASH
FREQUENCY CONTROL BO
RAMP AMPLIFIERS
HYDRAULIC FILTER, EMER BRAKES &
L G AIR BOTTLE DRAINS

PULL
HANDLE →
TO JETTISON
CANOPIES

7
PUSH TO
OPEN DOOR
CANOPY
JETTISON
HANDLE INSIDE

← RESCUE

FACTORY STENCILS

THE FULL MEAL DEAL!
(AND WE MEAN THE FULL DEAL!)

FD48038

F-4 Phantom Factory Stencils

The subject of F-4 stencils seems to have been done to death, yet like almost everything related to the Phantom, what we *thought* we knew about them turned out to be woefully incomplete, and in many cases, downright wrong, based on what has been produced and published in the scale modelling universe on this subject. I know, I know... I can hear your eyeballs rolling back into your head even now. But hold on - the Phantom is without doubt the coolest military airplane ever made, right? And when you think "Phantom", if you're really honest with yourself, doesn't your mental picture include an airplane literally covered with stencil data? Be honest... Of course it does! Yes, it's true there are (almost) a million of them, but it's also true that every one of them had a purpose, even if sometimes they seem so blatantly obvious that only a dunce would need to be reminded of what they say. But we digress. And a model with all these stencils on it - done well - is going to attract attention and just plain look cool! And if they are approached in a logical, systematic, and methodical fashion, and if you don't attempt to apply all of them in one sitting, they're honestly not all that difficult to do.

When they were in the paint barn in St. Louis, brand new Phantoms were literally covered with stencil data all over the airplane. We've found some amazing consistencies throughout F-4 produc-

tion, from the earliest F4H-1s in 1958 right through the end of F-4E production in 1979. But we've also found a number of variations and deviations from the published standards that seem to have been quite widely used, almost none of which has been documented before.

F-4 factory "stencil" data can be broken down into three distinct categories. 'Access Door Markings' (also known as panel numbers), the one that usually causes most modelers consternation, alerted ground crews to the identity of a particular panel, and usually an indication what was behind it. 'Instructional Markings' includes things like cautions, warnings, and other "instructional" items such as locations of antennas, safety pins, etc. The final category is servicing

and precaution markings. This includes symbolic markings for servicing things like oxygen, hydraulics, and fuel, as well as hoist point and jack pad locations, among others. All Phantoms regardless of specific subtype shared the great majority of these markings, since most of the things they bring attention to are found on all variants of the F-4. Over the 20+ year production life of the aircraft, some minor changes were made, and there were also variations in markings required by the Navy/Marines vs. the USAF and foreign F-4 users. On export F-4s the stencil data was applied in English just like the American versions, with the notable exception of the F/RF-4s supplied to Germany, which had bilingual stencils (beyond our scope here).

McDonnell, and after 28 April 1967, McDonnell Douglas, delivered all

USN/USMC Phantoms in the same Light Gull Gray over white camouflage, so their factory applied stencil data remained fairly consistent, with only minor changes in the style of things like ejection seat warnings. The initial USAF F/RF-4C deliveries from 1963 through late 1965 left the factory in the USN scheme, and after that in McDonnell's version of USAF Southeast Asia camouflage.

Stencil data on the upper surfaces of all aircraft was black, while that on white surfaces and on the FS 36622 lower surfaces of factory SEA camou-

flaged aircraft was in a medium greenish-grey, FS 16307.

Once an airplane had been in service for a while, it naturally came time for it to undergo some level of depot maintenance. In most cases, the aircraft was stripped and completely repainted, but in the case of early F/RF-4Cs in Southeast Asia, they simply had camouflage sprayed over their factory finish. The majority of the stencil data was obliterated and not reapplied, except for the white belly, which was left as-is. stencils included (see [fündekals sheet 48032](#)).

This decal is **only** concerned with the McDonnell/McDonnell Douglas factory applied stencil data. Anything that happened after the first depot overhaul is another subject entirely. What we aim to provide



Photo: USAF

here is a comprehensive and complete (to the best of our ability) set of factory style stencils that will allow you to accurately portray any F-4B/C/D/E/J/RF-4B/C/E as it appeared when the aircraft was newly produced and prior to its first depot repaint, with as many variations of individual markings as we're able to document. You can bet that as massive and t.e.d.i.o.u.s. as this project turned out to be, we have undoubtedly made some mistakes and/or omissions here or there, and for that we offer our humble apologies.

A few things about these factory stencils that it seems no one has ever documented... The Access Door Markings often had white "dots" overlapping the access door edges, usually positioned between the two door numbers, but almost as often somewhere near them. These white dots are pretty small, but if you look at photos of new F-4s, you see them everywhere. They were final inspection stickers, indicating that the panel had been inspected and passed for delivery. The dots stayed on however, and they were present on aircraft right up to their first depot repaints. At some point in the mid-1960s, McAir seems to have stopped, or at least cut back on using them, but then inexplicably, they reappeared, and were seen right through the end of F-4 production in the late 1970s.

Another oddity is the use of what we describe as a 'salmon pink' shade instead of bright red on a very select few stencils on USAF and export aircraft. We first thought this was simply faded red, but the more we looked, the more we saw brand new airplanes with this color, and the salmon color in close proximity with normal bright red markings, indicating that it was in fact a variation in color of the items in question. Why, we don't know, but there it is!

Many items underwent gradual change. A good example is the ejection seat warning triangles. Initially, on Navy/Marine F4H-1s and well into F/RF-4B production (through January 1966), the triangle was an isosceles (two equal sides, with one longer side) that was white with a red border and red lettering. Later, and on all USAF F-4Cs and subsequent variants, it was a red equilateral triangle with white lettering inside and "salmon pink" (later red) lettering on the outside. Another example is the arresting hook warning. Initially this was a small red "WARNING" placard the same size as all the others on the aircraft, with no white background. If you've ever been up close and personal with an F-4 hook, you know that if it came down on your head nothing good would happen. So as production progressed, a much larger white rectangle with a large red warning and a red arrow below it began to be applied on USAF and export aircraft. Interestingly, we initially thought this item, which was a big decal, was produced with a translucent white background, since you can clearly see the underlying camouflage color bleeding through it in many photos. But a close look at the McDonnell factory paint spec sheet for the F-4E, buried deep in the notes are instructions for the painter to mist the local camouflage color over large white markings. Once you notice it, it's there very frequently. We have also seen instances of USAF and export aircraft

with the local camouflage color misted over some of the safety and rescue markings on the nose to tone them down as well. It seems this was left to the fancy of the individual wielding the spray gun.

In every case we have been able to document, McDonnell and McDonnell Douglas used the Futura font family for these markings. See the section on the history of the Futura font family for more information.

The locations for individual items were often quite liberally interpreted. Even on aircraft close together on the assembly line, the precise locations for individual stencils could vary quite a bit. Access door markings obviously needed to be applied to the actual door they called attention to, and the tech orders usually gave quite specific location information, but it was not always adhered to. They were often moved to clear service-specific markings and titles. Other types of markings could vary even more in their application location. As always, if you're

unsure, we recommend doing it the way the tech order shows it (which is what we have shown here) unless you have a photo to prove otherwise. Since we have broken down each category of markings into separate drawings, there is a chance of interference in the locations for some items. We have done our best to show them in positions that will not cause interference, so double check before committing a decal to its final

How to identify McAir factory stencils

CAUTION

TO PREVENT EQUIPMENT DAMAGE
REFER TO MAINTENANCE MANUAL
FOR RADOME OPERATING PROCEDURE

Factory stencils applied
using Futura Heavy font, with
no stencil breaks in letters.

CAUTION

TO PREVENT EQUIPMENT DAMAGE
REFER TO MAINTENANCE MANUAL
FOR RADOME OPERATING PROCEDURE

Depot stencils applied using
various styles of lettering
with stencil breaks in letters.

position on your model.

One last thing to bear in mind (once again.): this decal covers **only** the versions of the Phantom actually produced as new aircraft by McDonnell and later McDonnell Douglas. Thus, **these decals do not apply** to any **F-4N** (upgraded F-4Bs converted by NADEP North Island, California), to any **F-4E with a serial 71-0236 or lower with retrofitted slats but no TISEO pod**, to any **F-4G** (the USAF Wild Weasel version), nor to any **F-4S**. Those variants all came into being after the airframes had already been in service. Just to be clear, **these decals DO**

apply to all F4H-1s, F-4Bs, F-4Cs, F-4Ds, F-4Es (those with the hard wing, and with factory installed slats and TISEO pod, serial number 71-0237 and higher), F-4Js, RF-4Bs, RF-4Cs, and RF-4Es as built by McAir.

As you will have no doubt noticed by now, we have arranged our instructions to help you with this gargantuan task, hopefully without losing your sanity - or at least most of it. We have attempted to make this as painless as possible by breaking down the task into manageable bites. We strongly recommend tackling this as a number of small projects so as not to get frustrated. We have presented each section of the airframe and each category of markings as a separate page to allow the illustrations to be shown at maximum size for clarity.

Again, we have attempted to show the locations of the various decals in their actual positions, so if you apply them precisely as shown, you should not have any overlap or interference of one marking with the other. Individual kits will have slightly different shapes and details, and in some cases there are panels or panel lines missing or in the wrong place. So go count some rivets, and rest well knowing it's going to be a killer looking model sitting on your shelf!



Have Fun!!

How did they do it?

Until sometime in the mid to late 1970s, F-4 stencils were applied using decals. These most closely resemble modern "removable film" decals, though it is not exactly the same process. The designs were silkscreen printed backwards onto a solvent-release backing paper with adhesive applied over the printed designs, and then a protective sheet over everything. To apply the decal to the aircraft, each item was cut from a large sheet containing many decals (just like ours) and soaked in a special solution to soften the adhesive and release the printed image from the paper backing. The paper was then placed in position on the aircraft, squeegeed to remove liquid and air bubbles, allowed to dry for a set period, and then the paper backing was peeled away. This left only the printed image attached to the aircraft skin, with no "clear film" as you find with water slide decals for models. The adhesive was extremely aggressive - to the point that when it came

time to strip the aircraft, the markings had to be scraped off, then the aircraft sand blasted to remove the residue. It's clear this must be true, since even supersonic speeds, with the blast effect of the supersonic slipstream and high temperatures never seemed to faze these stencils! There are Iranian F-4Ds delivered in 1967 and 1968 that still have these decals on them in 2022! Even if they were reapplied during depot overhaul using factory decals, Iran could not have received any new decals later than 1979, so that gives them a minimum 40-50 year life span. Pretty impressive!

From sometime in the 1970s until the end of production, it appears the markings were painted on, although the exact method of application is not clear to us. But since the appearance of the stencils to the observer is absolutely identical. Practically speaking, on a 1/48 model there is no difference.

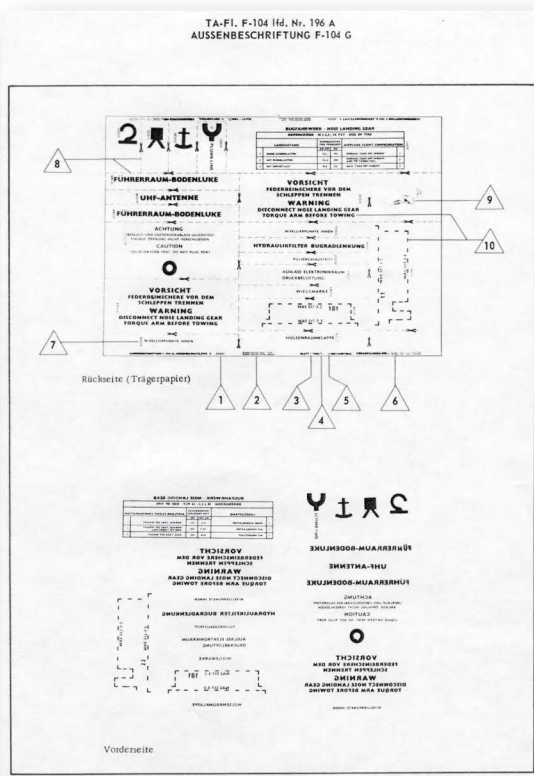

Although these pages are from a Luftwaffe F-104G manual, they illustrate the method of stencil application that was also used on the F-4 family.



Polka Dotted Phantoms?

As if applying all these Access Door and Instructional markings wasn't enough (come on, you know you love it!), the vast majority of new F-4s left St. Louis festooned with white dots. These were final inspection stickers applied prior to handover to the customer, indicating that everything was ship shape. As you can see in these photos, the dots generally correspond with the Access Door markings, often being applied between the two numbers, or at least somewhere near them, overlapping the removable panel and the skin next to it.

You see these dots on every Phantom variant from the first F4H-1 to the last F-4E. For some reason they seem to have fallen out of use, or at least widespread use, during the late 1960s, but then they reappeared, and could be seen right through the end of production in 1979. Some aircraft were covered with them, and others had few or none. Feel free to use them liberally, not at all, or somewhere in between (depending on your state of sanity). We have provided a lot of them, so you should have all you need and plenty to spare.



Left: an early RF-4C in the Light Gull Gray over white scheme on the ramp in St. Louis showing the white dots between or near the Access Door markings.

Fündekals collection

Below: an in-service F-4J from VF-121, still covered from stem to stern in white dots.



Fündekals collection

Below: a late production F-4E-60-MC wearing her full factory camouflage and markings. She has some white dots, but is not covered with them as was seen on many aircraft. We can't explain the difference.



Courtesy Henk Schuiltemaker

Back to the Futura (Heavy)...



Okay, we'll admit it: we're type geeks. Typography is a fascinating subject with some often surprising history. Aircraft manufacturers applying maintenance and safety information to an aircraft want to use type that is easily readable, and helps to clearly convey the information they seek to convey.

When we think "stencils" on aircraft, what usually springs to mind is a picture of lettering applied by being sprayed through a paper or metal stencil, which means letters with breaks in them to keep all the pieces of the stencil together. But when a manufacturer is applying maintenance, servicing, and safety information on a brand new airplane, they typically use other methods as outlined elsewhere. In the case of McDonnell (as well Lockheed, and possibly others), they chose the ubiquitous Futura font family.

Despite its name, the Futura family dates back nearly a hundred years, to the mid-1920s. At that time, the Bauhaus design movement was in full swing, with the trend toward clean, modern, minimalist design. Bauhaus sought to eliminate all ornamentation and unnecessary complexity in everything from buildings to street signs to toasters.

Type designer Paul Renner at the Bauer Type Foundry in Germany began sketching what became the Futura font family as early as 1924, and the font was released in 1927. Futura was heavily marketed by Bauer and its American subsidiary as "die Schrift unserer Zeit" ("the typeface of our time") and "the typeface of today and tomorrow". It lived up to the name, and has maintained its popularity ever since, used in many famous logos such as Volkswagen and IKEA.

McDonnell chose Futura Heavy for F-4 stencil data. In common with the entire Futura family, it is a clean, very legible font that balances the need to be clearly readable without being as "in your face" as a more bold font might be.



Lemon.

This Volkswagen missed the boat. The chrome strip on the glove compartment is blighted and must be replaced. Chances are you wouldn't have noticed it; Inspector Kurt Kroner did.

There are 3,389 men at our Wolfsburg factory with only one job: to inspect Volkswagens at each stage of production. 3,000 Volkswagens are produced daily; there are more inspectors than cars!

Every shock absorber is tested (spot checking won't do); every windshield is scanned. VWs have been rejected for surface scratches barely visible to the eye.

Final inspection is really something! VW inspectors run each car off the line onto the Funktionsprüfstand (car test stand), take up 189 check points, gun ahead to the automatic brake stand, and say "no" to one VW out of fifty.

This preoccupation with detail means the VW lasts longer and requires less maintenance, by and large, than other cars. It also means a used VW depreciates less than any other car.



We pluck the lemons; you get the plums.

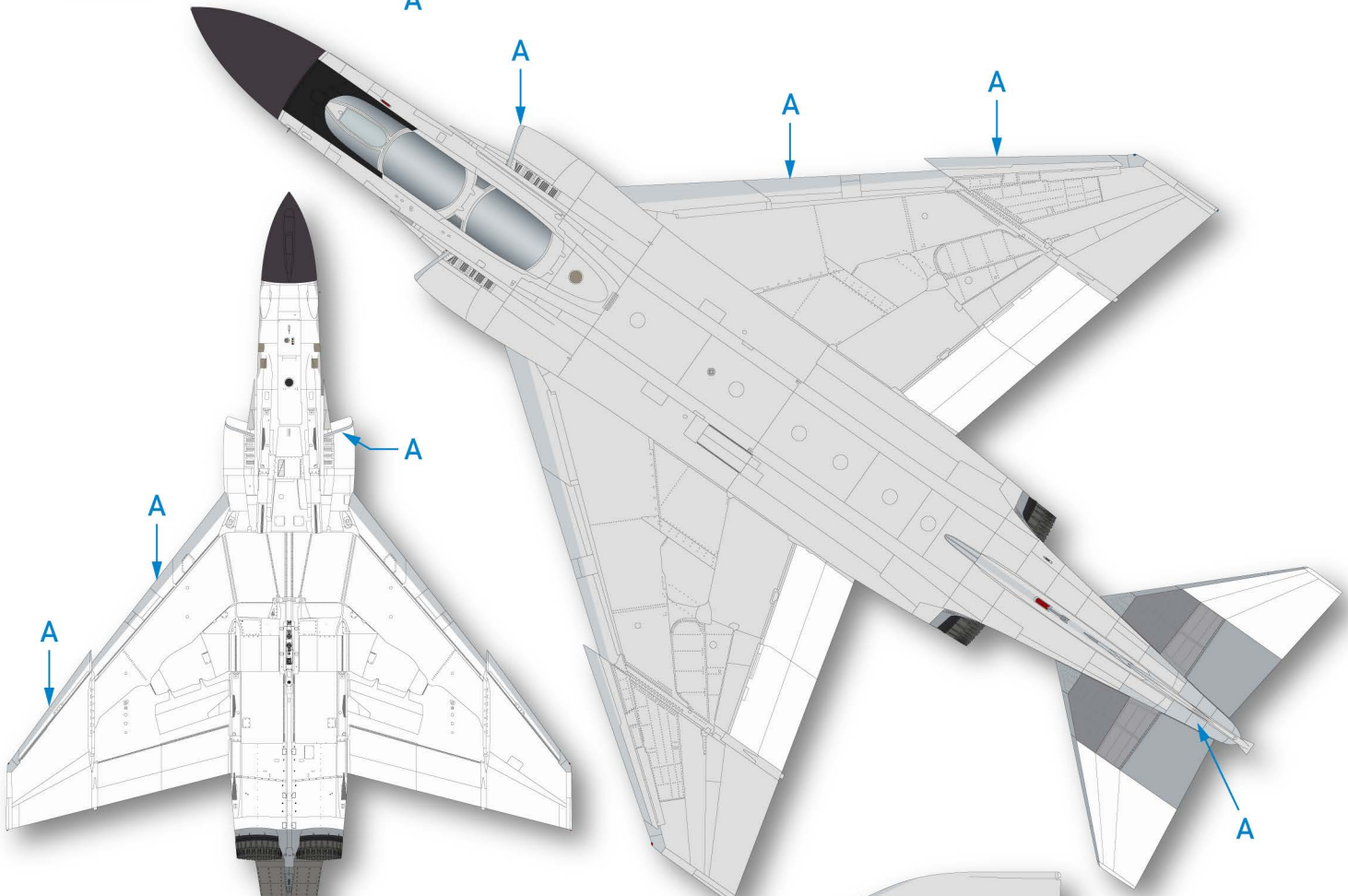
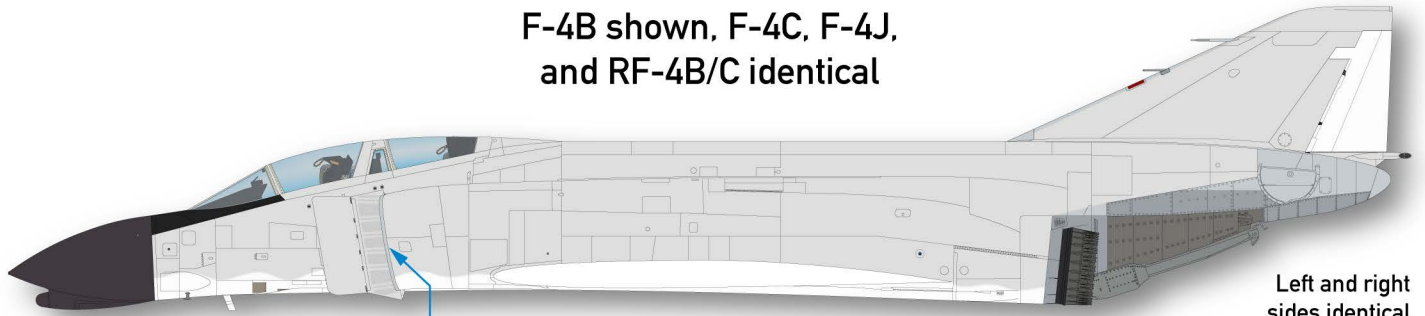

Two examples of Futura from the 1960s: the iconic Volkswagen "Lemon" ad from 1960, and the placard affixed to the leg of the Apollo 11 Lunar Module left on the moon in 1969.

F-4B shown, F-4C, F-4J,
and RF-4B/C identical



-  FS 36440
-  FS 17875
-  Corogard
(aluminum paint)

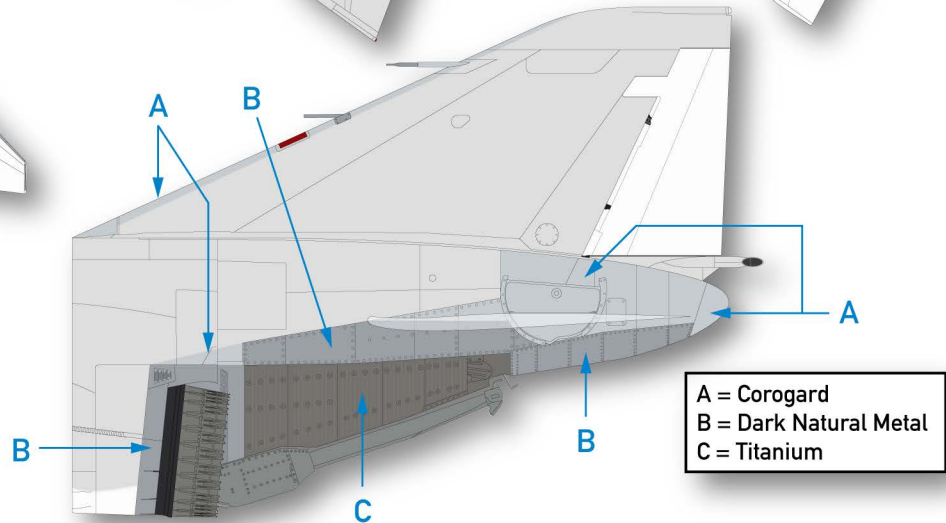

Navy Camouflage

When the F4H-1 first flew in 1958, the Navy had been using the Light Gull Gray over gloss white scheme for several years. All F4H-1/F-4B, F-4C and RF-4C through late 1965 (F-4Cs 64-0881 and lower and RF-4Cs 65-0838 and lower), all F-4Js and RF-4Bs were delivered in this same camouflage scheme. The upper surfaces, while specified as fully matte FS 36440 were really more an eggshell finish that would weather toward a flatter finish in service. Lower surfaces were gloss white, and the leading edges of the intakes, wings, and vertical fin were finished in 3M Corogard paint, a semi-gloss aluminum color. On all aircraft through F-4J-31-MC BuNo 153876 (delivered 17 Oct 67), the aft fuselage above/behind the horizontal stabilators, and the drag chute door were finished in Corogard. After that they were left

shades of natural metal, with the drag chute door/tail cone finished in FS 36440. All F-4Cs and RF-4Cs in this scheme had the Corogard on the aft fuselage, since factory SEA camouflage was implemented in late 1965 on those types.

The camouflage pattern was very consistent, with the characteristic wavy demarcation between the white and the grey. The anti-glare was black on all aircraft with the notable exception of the two F-4Bs that were painted as F-110As in 1962. Those had FS34092 anti-glare panels. On early F4H-1s/F-4Bs and F-4Cs the black neoprene radome finish could have a decidedly reddish/brownish appearance and weathered quickly to a patchy appearance. Later an improved formulation was developed and the coating wore better.



F-4G 150645 (a modified F-4B) in her factory camouflage.



F-4B 62-12194 at Davis-Monthan AFB in 1964.

RF-4C 64-1077 showing the treatment of the camouflage on the nose.

F-4C 64-0707 on display. Note the plethora of white inspection dots, and the very visible "pie wedge" of Corogard above the exhaust nozzle.



A pair of F-4Js demonstrating how remarkably consistent the camouflage application was throughout production for the Navy.



Southeast Asia Camouflage

As America's war in Southeast Asia ramped up in 1965, the need for an effective camouflage scheme suited to the jungles over which the air war was being fought became obvious. The Navy's camouflage scheme of Light Gull Gray over white was simply too bright over the lush foliage of Thailand, Laos, Cambodia, and Vietnam. Beginning with the last production block of F-4Cs delivered in late 1965, McDonnell began applying the then-new Southeast Asia colors and pattern developed by the USAF on all production USAF aircraft. This scheme would remain constant on all new USAF F-4s through the end of production, and was applied to most export F-4Es and RF-4Es as well.

(even when brand new) than the FS595 color. Both of the greens (FS 34079 and FS 34102) were also somewhat lighter than the standard, and all of the paints were very susceptible to almost immediate fading and chalking when exposed to even the relatively mild climate of northwest Europe. This is demonstrated by the need, especially in the harsh climate of Southeast Asia and the desert southwest of the U.S., for frequent touchups and the often downright dreadful appearance of even relatively fresh factory applied camouflage colors.

McDonnell developed its own unique version of the USAF T.O. 1-1-4 pattern for the F-4, and there are several key features of it that will help



Photo courtesy Don Gilham

A spectacular shot of RF-4C-38-MC, 68-0565, taken at RAF Upper Heyford on 14 May 1969, *two days* after delivery to the USAF in St. Louis! Note the pale shade of tan compared to the RF-101 next door - absolutely characteristic of fresh McAir camouflage paint. Also note the bright red (vs. salmon) warning stencils around the nose.

The Federal Standard 595a color system had come into use in the mid-1950s as a way to standardize what had been a haphazard group of often conflicting Federal Government and Department of Defense color standards. All descriptive color names were eliminated (officially at least) and a fool-proof system of five-digit numbers identifying each color implemented.

Contractors were supposed to match the FS colors as closely as possible, but variations were frequent and often large. The vendor chosen by McDonnell was guilty of some pretty awful matching on F-4 paints procured from 1965 through at least the early 1970s. The FS 30219 in particular, was much lighter, greyer, and more chalky looking

you identify factory camouflage from a depot-applied camouflage. See specifics on the following pages.

Other things to note on factory SEA camouflaged aircraft are the presence (until around 1973) of the red turbine warning stripe across the upper fuselage. While it had also been applied to the belly on USAF F-4s in the Navy camouflage, it was discontinued on the belly with the advent of SEA camouflage. The stripe was applied leaving an approximately 2" gap between it and the national insignia. For some reason, many early F-4Ds and Es had the turbine warning painted out by squadrons, usually with much darker FS 34079. Also note the missing paint on the screw heads near the cockpit - even on a two-day old bird!

While the aft fuselage area above and behind the horizontal stabilators had been finished in Corogard paint on the Navy style scheme, with the advent of SEA camouflage the entire aft fuselage was left in shades of natural metal, and the small "pie wedge" of Corogard directly above the exhaust nozzle was eliminated as well. The drag chute door was painted FS 34079. On many F-4Ds and Es, the inboard portion of the horizontal stabilators was painted glossy black. See separate section on this black protective paint.

Around 1971-72 either the paint vendor got its act together, or McDonnell Douglas changed vendors. Either way, the colors applied after that conformed much more closely to the FS595 standard, and they were not subject to nearly as much color shifting, fading, and chalking as the

older paints. Did the USAF finally protest? We'll never know.

Another interesting (?) factoid worth mentioning here - nearly all artists and hence modelers tend to paint colors in order from lightest to darkest. But in virtually every photo we have seen with high enough definition to discern it, the FS 30219 tan was painted last, as in, *over* the two green shades. The tan overspray on the green shades makes this obvious, as does the green showing through worn tan paint. And even more interestingly (??) this is the case for both McDonnell factory applied camouflage as well as USAF depot repaints. It is especially obvious on the first batches of depot camouflage on the Thai and Vietnam-based F-4Cs in 1965-66 performed at Clark AB, Philippines and Tainan, Taiwan.



Fündekals collection

F-4D-26-MC, 65-0580 was delivered on 27 May 66, and lost on 24 Apr 67, less than a year later. She served with the 36th TFW at Bitburg AB, Germany where the weather was nowhere near as harsh as Southeast Asia, yet she is already faded, chalky, and has been touched up in several spots.

F-4D-29-MC, 66-7466 was delivered in Jan 67, and is seen here in Jul 68 while assigned to the 431st TFS, 479th TFW at George AFB, California. Note the very faded, chalky appearance of her factory camouflage after only 17 months in service.

RF-4C-31-MC, 66-0434 was delivered in Jul 67, and assigned to the 15th TRS at Kadena AB, Okinawa. The factory tan is nearly mauve, with lots of touchups. The FS 34102 has become completely dead flat (almost velvety), with a distinctly yellow shift.



Fündekals collection



Fündekals collection

F-4D-31-MC, 66-7741 was delivered on 21 Jul 67 and is seen here in 1968-69. Her paint is so badly faded it's almost impossible to tell what the colors started out as! McDonnell's FS 30219 often faded to something that looked like something between beige and a purplish mauve color.



F-4E-32-MC, 66-0303 was delivered on 1 Feb 68, and demonstrates her clean, new factory finish in a flight over St. Louis before delivery. Note her black painted inboard stabs, and oddly, a white (?) vari ramp on her intake splitter.



A late build F-4E-61-MC, 74-1620, delivered 6 Jul 76, is seen absolutely factory fresh and pristine, with no unit applied markings. Note that the pattern is unchanged since 1965, but these later aircraft were finished with paints that much more closely matched the FS595 standards. White dots have disappeared, though we have seen other contemporary aircraft that had them, so check references. Also note the use of the bright red warning placards around the cockpit in place of the 'salmon' versions. Also note the misting of green and tan paint over the hook warning placard, as well as over the rescue and ejection warning placards below the cockpit.

Although slightly too fuzzy to make out her serial, all the hallmarks of a McDonnell factory camouflage finish are present on this 8th TFW Wolfpack F-4D, seen refueling somewhere over Southeast Asia, probably in 1968 or '69. Of particular note is the massive amount of dark green showing through the FS 30219 tan - conclusive proof that the tan was the last upper surface color applied. This was the same for the aircraft camouflaged at the Clark and Tainan depots in 1965 and '66 as well. Her upper port intake and splitter ramp are very scarred up from crew boots as well. The areas on the upper side of the intakes and wings where the crew normally walked are where the majority of the green shows through the worn tan. Also note the different, more vibrant color of the Corogard walkway trapezoid at the wing root. Break out the Scotchbrite!



McDonnell

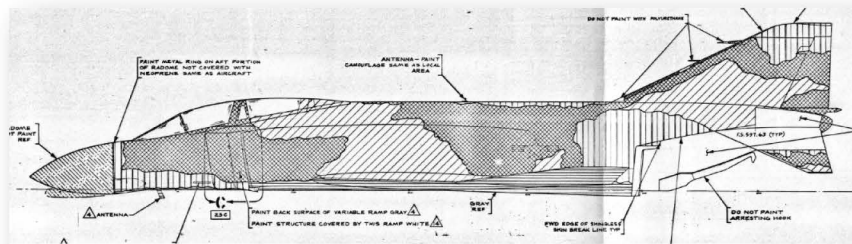

T.O. 1-1-4

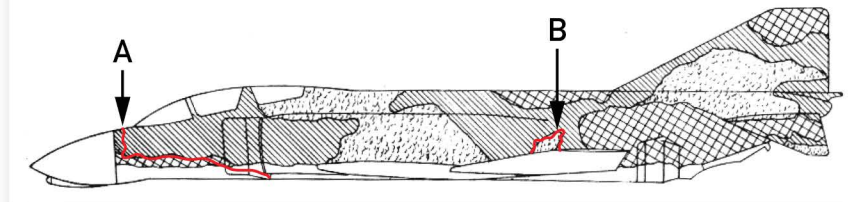

A comparison of the McDonnell F-4C Southeast Asia camouflage pattern for the fuselage vs. the USAF T.O. 1-1-4 version. There are some notable differences in the patterns, shown here in red.

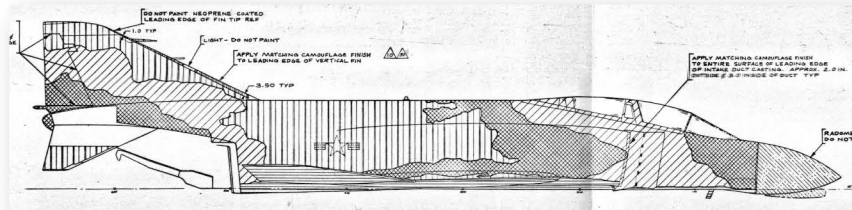

McDonnell

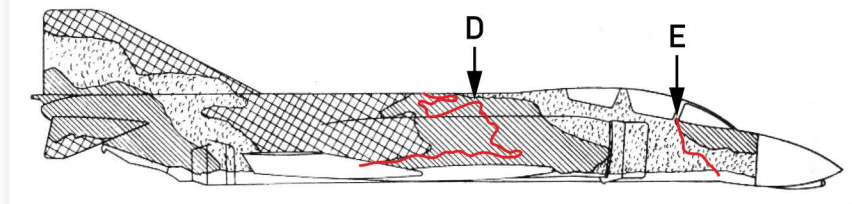

T.O. 1-1-4

Notes:

A: The FS 34102 green area takes a 90 degree turn up to follow the aft end of the radome on the McAir version.

B: The 'spike' of FS 30219 on the McAir interpretation is almost always a much more "wiggly" pattern. On many depot repaints it is a simple bubble, or even completely missing on occasion.

C: The aft fuselage cooling scoop on all McAir camouflaged aircraft appears a considerably darker version of the local camouflage color. See following page for more information.

D: The pattern of FS 34102 on the right side is much more wiggly on the McAir version. Most McAir painted aircraft feature a large 'pan handle' shape on the side of the intake that is almost always completely missing on depot repaints (not as evident here as on most actual aircraft).

E: McAir's pattern has the FS 34079 flowing down across the ECS inlet and touching the grey belly, which it almost never does on depot repaints.

F: On all McAir factory camouflage, the parabreak door is painted FS 34079. On depot repaints it is sometimes painted and sometimes left in natural metal.

G: McAir always left the walkway area on top of the very aft end of the fuselage natural metal. On depot repaints it was most often painted. On many depot repaints, everything above the stabs was camouflaged.

H: The local camouflage color extended 36" back from the lip on the inside of the outer intake. On the ramp it continued back to the hinge at the aft end of the vari-ramp.

The McAir camouflage finish specification drawing for the Southeast Asia scheme is literally covered with notes on various specific areas of the aircraft and how they are or are not to be finished. We will let the ones shown here speak for themselves.

CAMOUFLAGE PATTERN ON AIRCRAFT SHALL APPROXIMATE THAT SHOWN BUT NEED NOT DUPLICATE IT EXACTLY. DEMARCATION AREA BETWEEN COLORS SHALL BE BLENDED.

MARKINGS REQUIRING YELLOW OR WHITE PAINT SHALL BE FOGGED OVER WITH A THIN COATING OF GREEN OR TAN AS REQUIRED TO TONE DOWN THE BRIGHT YELLOW OR WHITE.

PAINT ALL LEADING EDGES (EXCEPT STABILATOR) WITH COROGARD TO MATCH CAMOUFLAGE COLORS OF SURROUNDING AREAS PER MAC P3. 13415.

PAINT INNER SURFACE OF SPEED BRAKE DOOR & ACTUATOR RED TYP 

PAINT INTERIOR SURFACES OF SPEED BRAKE WELL GRAY, COLOR NO. 36622, SAME AS UNDER SIDE OF AIRCRAFT TYP

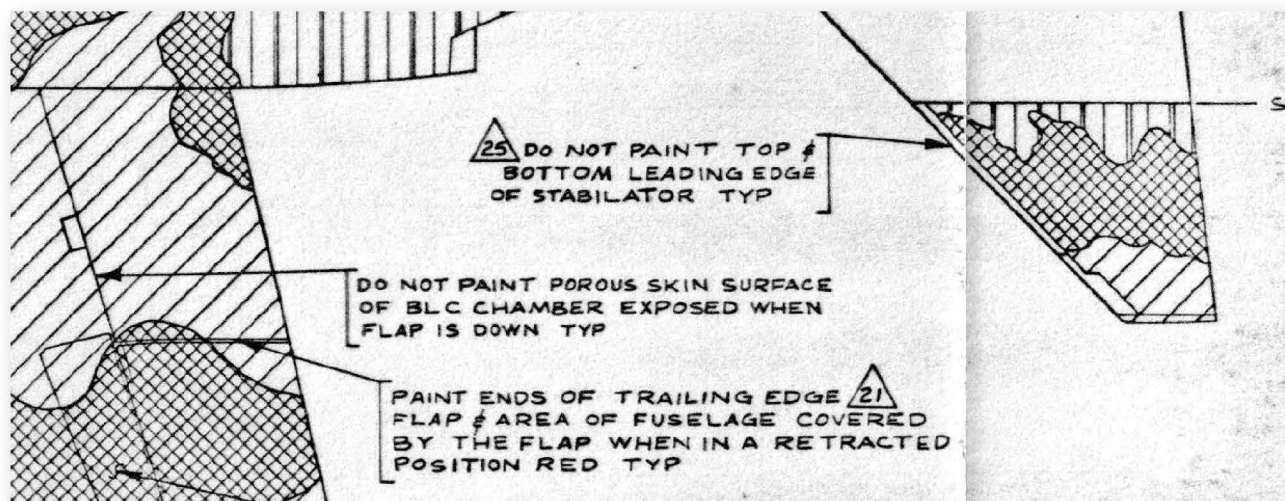

Above and below: specifications for wing and stabilator finish. Note that all leading edges (wings, vertical fin, and intake lip) were finished with Corogard paint. This appears to have been matched to the camouflage colors quite well, since in most cases no difference in tone is seen in photos. The note at the very bottom of the diagram below talks about the BLC exhaust panel on the wing upper surfaces (decals Q1-Q4).

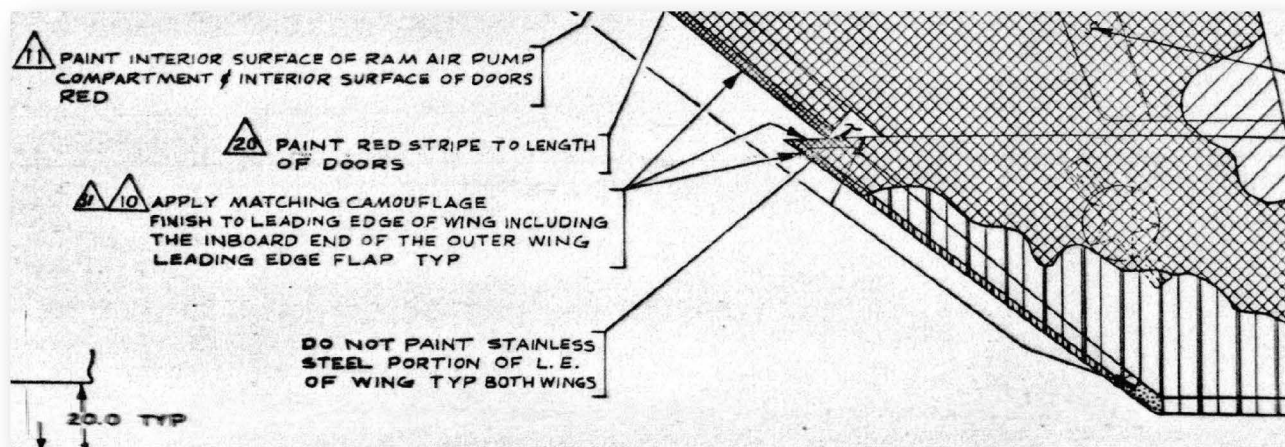

Additional information on the wing finish. Note that the interior of the spoilers and their wells were to be finished in the local camouflage color. You almost never see F-4 spoilers open when the aircraft is on the ground, but if you used them in the air, you didn't want the bad guys to spot you!

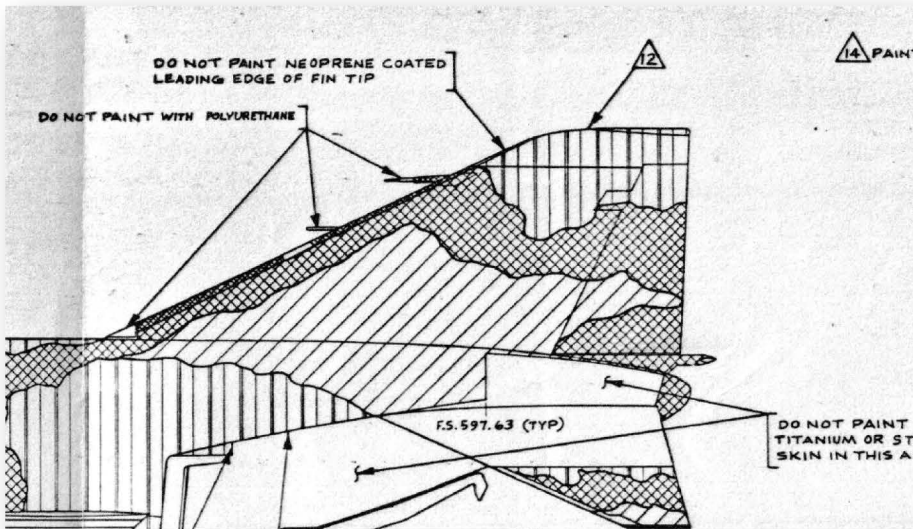
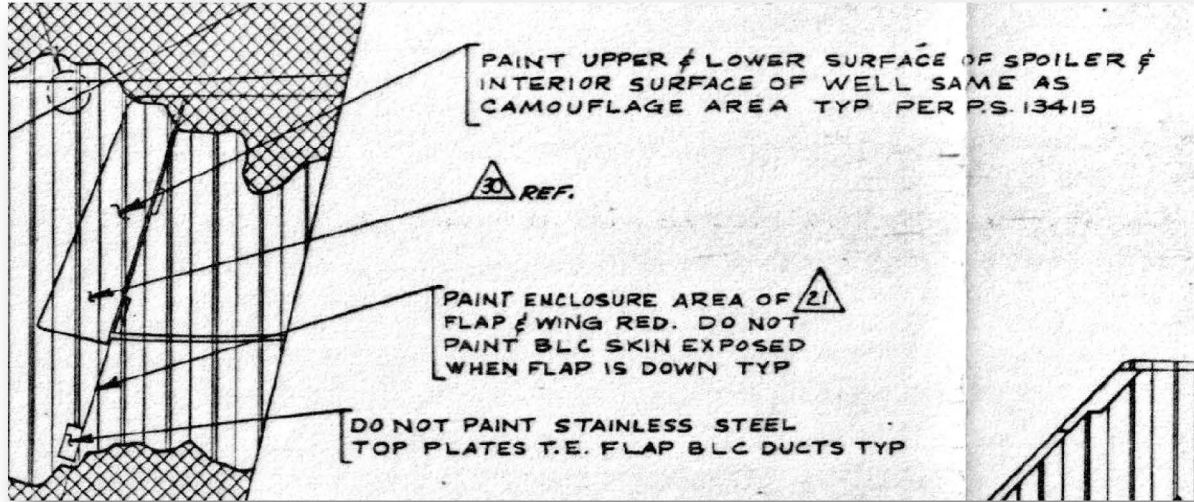

Above and right: specifications for the vertical fin and aft fuselage finish. All Corogard paint on the high temperature areas of the aft fuselage was eliminated on SEA camouflaged aircraft, although at the time it continued to be used on F-4Bs, RF-4Bs, and F-4Js for some time. Again, note the tinted Corogard on the leading edge. For some reason, the aft fuselage cooling intake at the base of the fin almost always looks much darker than the local camouflage color, even in direct sunlight.

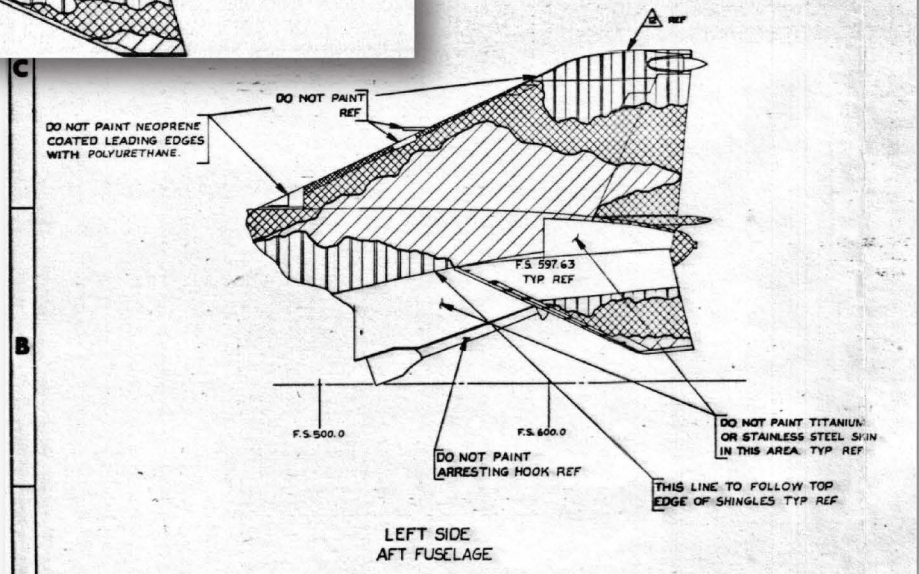

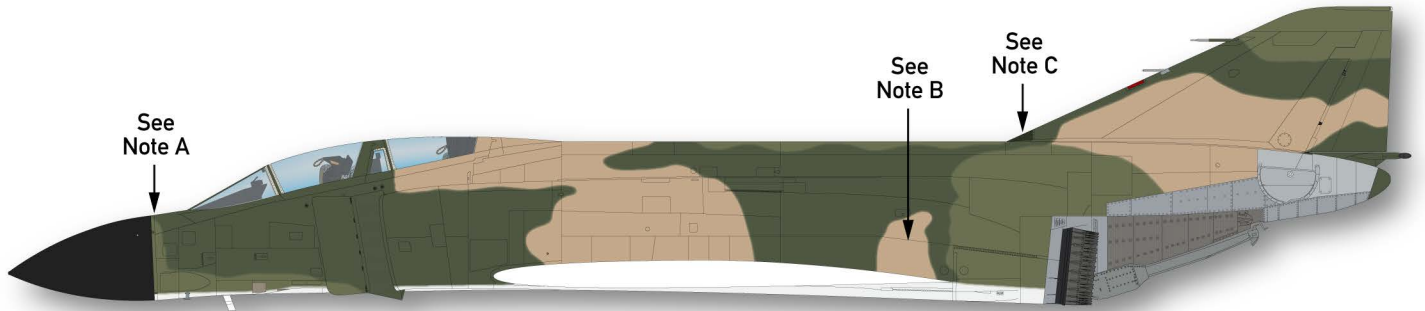

F-4D shown, F-4C identical

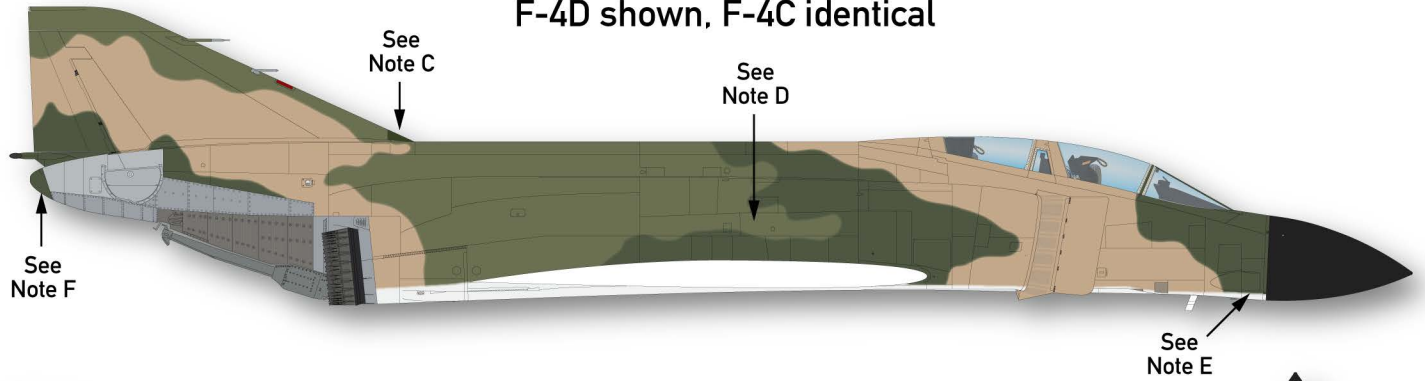

Notes located on page 12

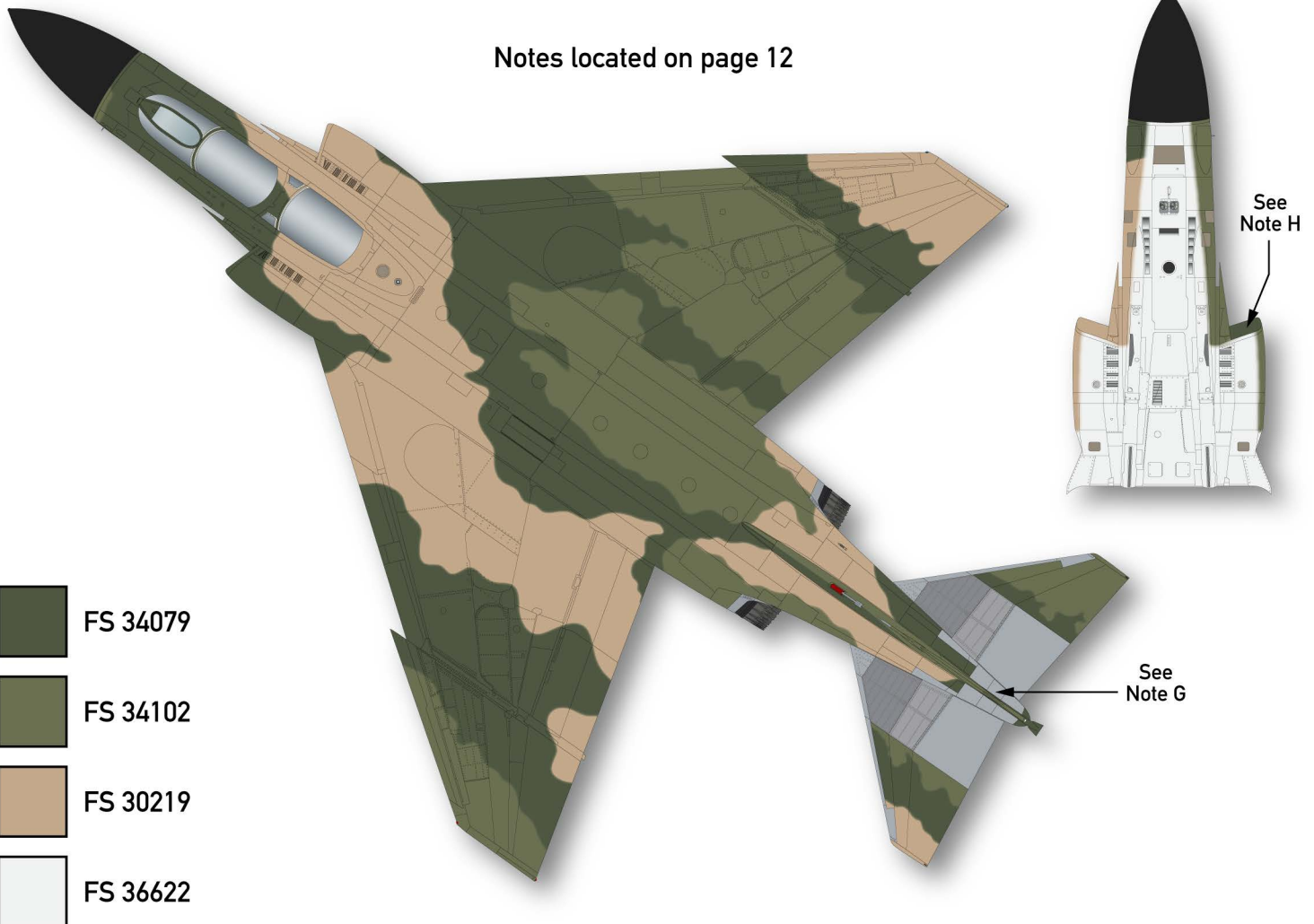

- FS 34079
- FS 34102
- FS 30219
- FS 36622



Fündekals collection



Courtesy Jerry Hughes



Courtesy Jerry Hughes

A trio of drop-dead gorgeous photos of F-4C-25-MC, 64-0923 (delivered 2 Apr 66), only five ships removed from the last F-4C produced, taken at the RAF Wethersfield, Essex open day in 1966. Lots of white polka dots everywhere. Note the dark colored blackout shade folded up inside the WSO's canopy - something every F-4 from first to last left the factory with, though the vast majority were yanked out as soon as the aircraft was delivered. Also note in the shot at left the round access door 124, indicating the aircraft was not equipped with the KY-28 secure voice system. Note how the FS 34079 curves down across the ECS inlet to touch the light grey belly - something almost completely exclusive to McAir factory camouflage. Note the black painted translating ring on the exhaust nozzle, but natural metal inboard stabs, as well as the FS 34079 painted drag chute door.

A photo too good not to include! Maj Tom Neal stands in front of F-4D-29-MC 66-0241 (delivered 6 Jan 67) "The Maverick", at Ubon RTAB, probably sometime in 1968. This bird was lost to AAA fire near Bac Giang, North Vietnam 18 Dec 71. She is seen here in her factory camouflage and markings, with added 433 TFS/8th TFW items such as the black inboard side of the nose gear door with her last three in white. She has a black armament loading placard added below the rescue arrow, a black crew name block, her name, and her last three in red on the nose gear door. Note the very pale tan color, and how badly faded her camouflage is, even this soon after delivery. Even the red ejection seat warnings are faded and chalky looking.

Note that she's loaded for both air-to-ground and air-to-air, with an

AIM-4D Falcon on the inboard side of her inboard pylon. The Falcon was universally hated (it was even less reliable than the AIM-9B), and was only carried by F-4Ds and early Es in Southeast Asia, and then not for long. Brig Gen Robin Olds recounted the cockpit gymnastics required to arm and fire the AIM-4D in a story that had the entire dinner table rolling on the floor with laughter! Other notable items are the relatively bright green touchup on the intake, the heavily worn paint on the intake and splitter plate, and the very light, almost off-white color of the dielectric panels near the AIM-7 well. Just visible at the far left is the arrowhead shaped APS-107 RHAW antenna, fitted to all early F-4Ds sent to Southeast Asia. There were four of these antennas, two upper and two lower, arrayed around the radome.



One of Maj Neal's three Distinguished Flying Crosses was awarded for disobeying orders by taking his four-ship into South Vietnam (flying into the RVN was not allowed from Thai bases) to save Marines under siege at Khe Sahn in 1968. But for Maj Neal's actions, Khe Sahn might well have been lost. He bombed North Vietnamese regulars and Viet Cong troops with anti-personnel munitions, saving hundreds of Marines, and eliminating large numbers of enemy troops surrounding them on all sides. Neal figured he would either be court-martialed or get a medal, but either way, it certainly wouldn't go unnoticed. Fortunately, it turned out for the best for both the Marines on the ground and for Maj Neal.



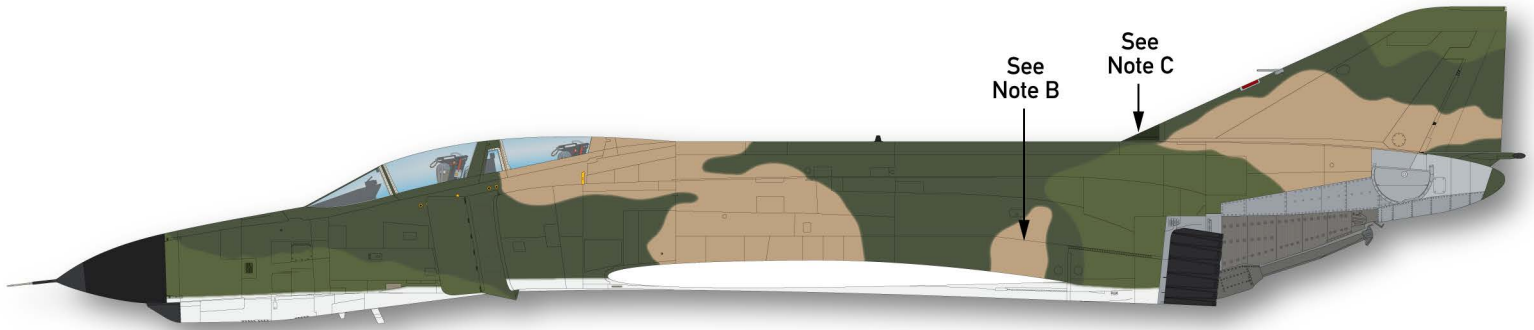

RF-4C/E and F-4E identical

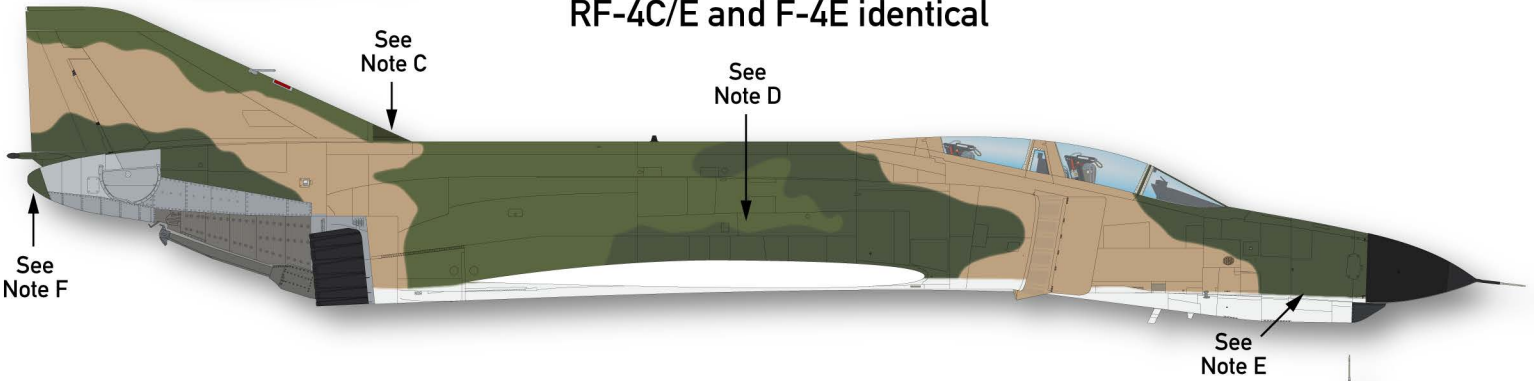

Notes located on page 12

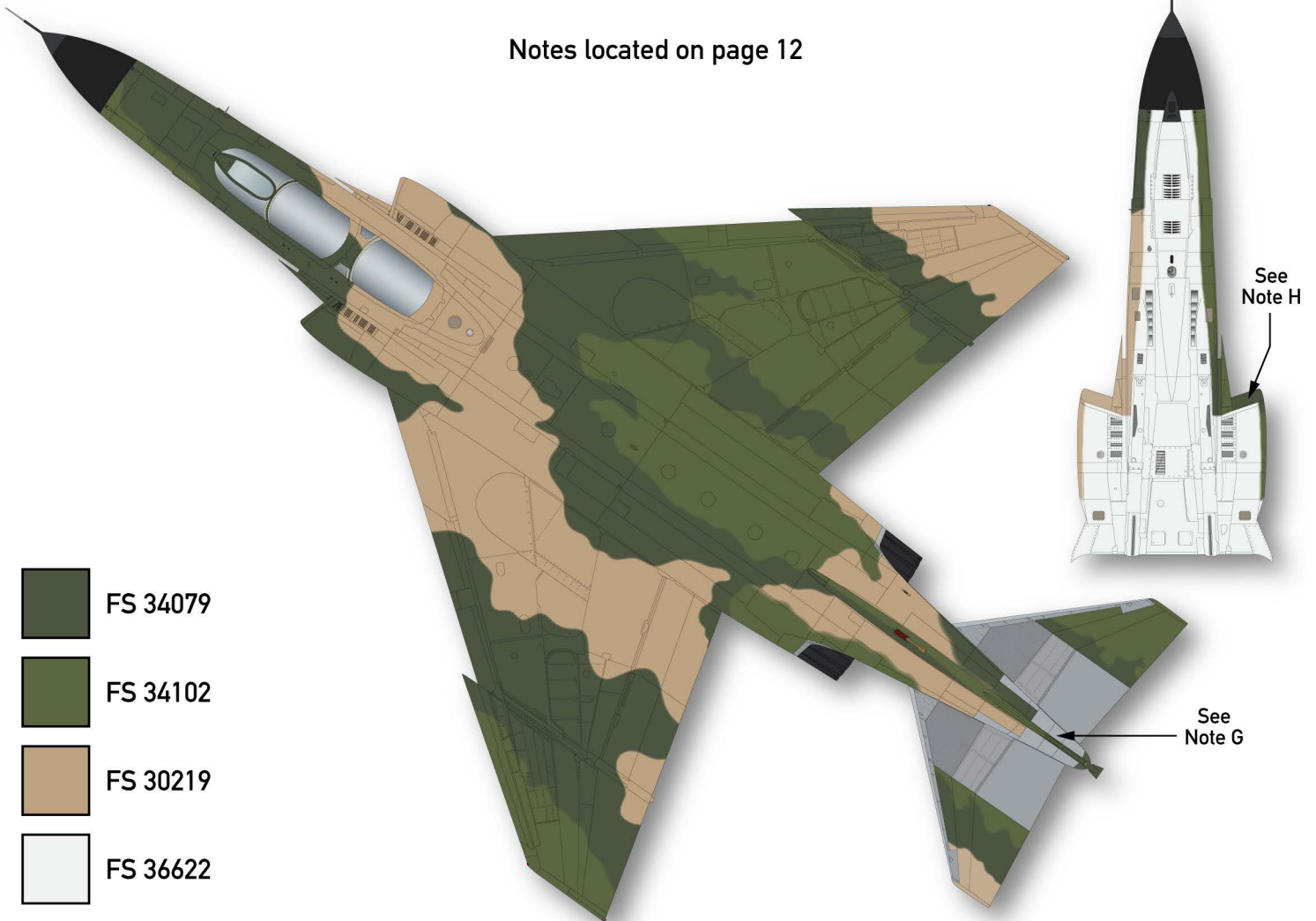

- FS 34079
- FS 34102
- FS 30219
- FS 36622



A fantastic series of photos of an RAAF F-4E on its delivery flight to Australia in 1970. Many items to note here! Note the difference between the color of the FS 34079 on the wing and that on the top of the drop tank. The McAir paint vendor's paint was lighter and chalkier looking, even when new. Note the darker appearance of the Corogard paint inside the right hand walkway vs. the lighter appearance on the left hand side. Note the rather 'fussy' demarcations compared to most depot repaints. Note the natural steel BLC exhaust outlets. Note the extra thin fiberglass piping around the canopies. Note the blackout curtain folded up in the back of the WSO's canopy. These were originally black, but later white. Note the full stencils but no white dots visible.

An early build F-4E in Thailand showing the full 'polka dot' treatment. She's had some mismatched camouflage touchups, but this is her basic factory camo. Note how quickly the McAir paints chalked and faded in the Asian weather. Note also the 'salmon pink' warning placards and "DANGER" titles around her ejection seat warning triangles.



A tight closeup showing how the 118/119L and R access door stencils could be at the bottom or the top of the circular doors, depending on the whim of the person applying them. Also note the color demarcation brought straight down from the trailing edge to the chine along the edge of the aft Sparrow well. Note that the red turbine warning stripe never touched the blue disk of the insignia. There was an approximately 2" gap on both sides. This aircraft has had some corrosion control touching up, but it is still in its overall factory finish.

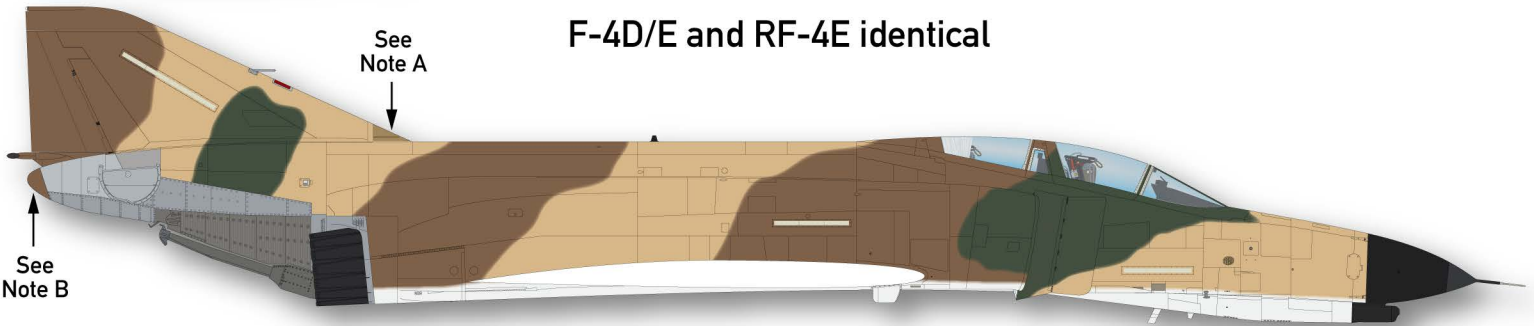
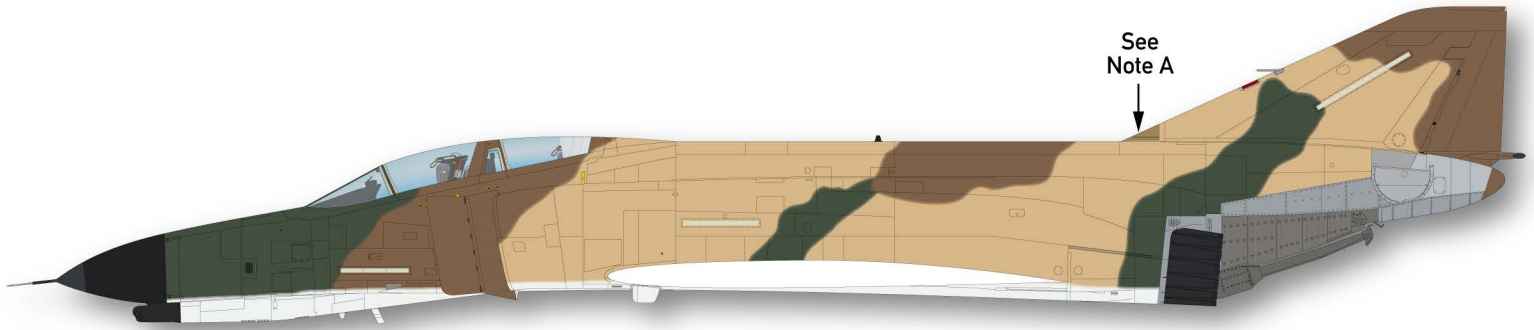





F-4D/E and RF-4E identical

Notes:

- A: The aft fuselage cooling scoop appears a considerably darker version of the local camouflage color. Oddly, this does not appear to be the case on all IIAF aircraft, so check references.
- B: The brake chute door is painted FS 30180.
- C: The inside of the intake is painted the local camouflage color for 36" aft from the lip.
- D: The walkway area next to the vertical fin is natural metal along with the aft fuselage area.

Detail Note

Rather oddly, it appears that in some places the brown is painted over the green (eg. left upper wing), while in others the reverse is true!

-  FS 34079
-  FS 30180
-  FS 30400
-  FS 36622

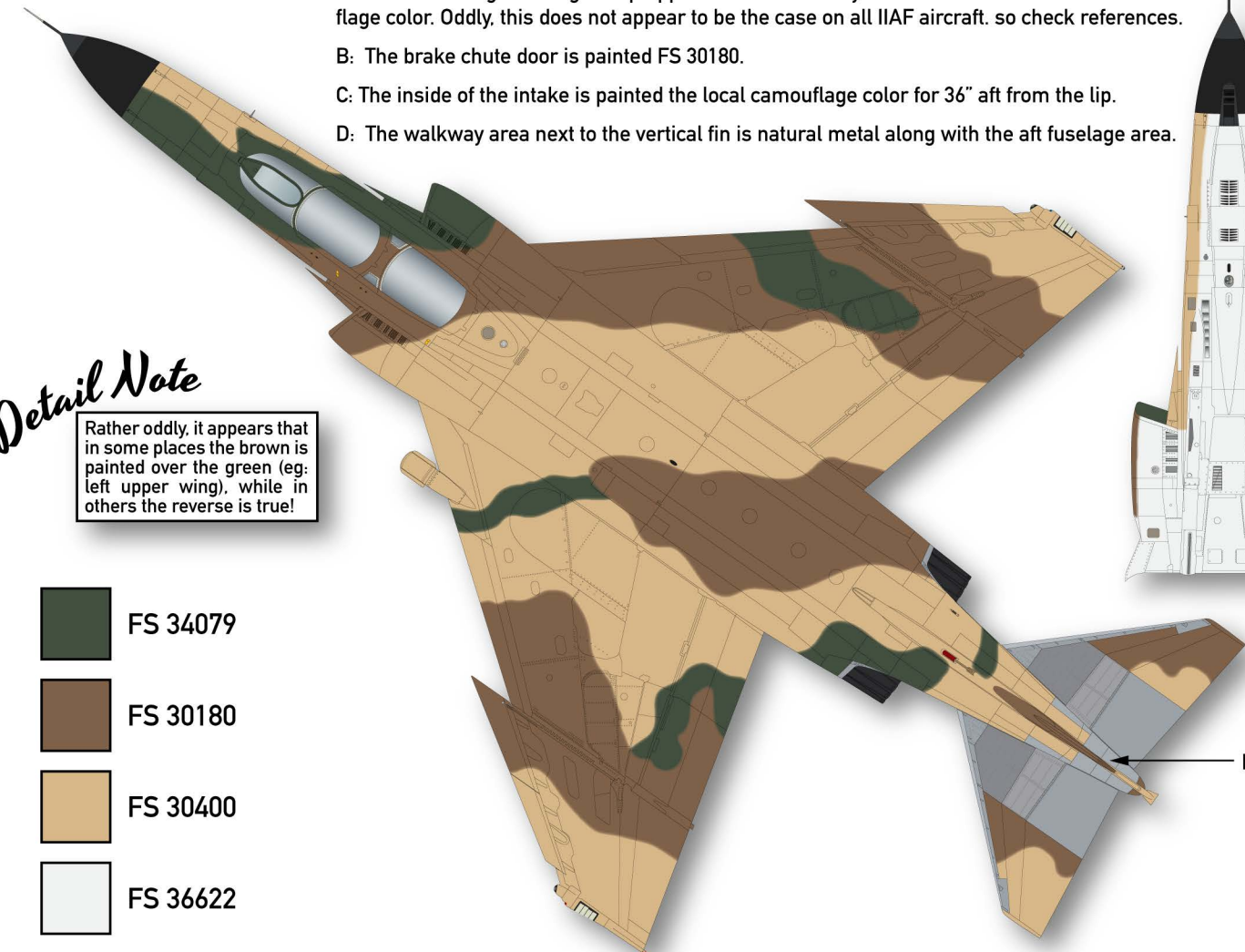
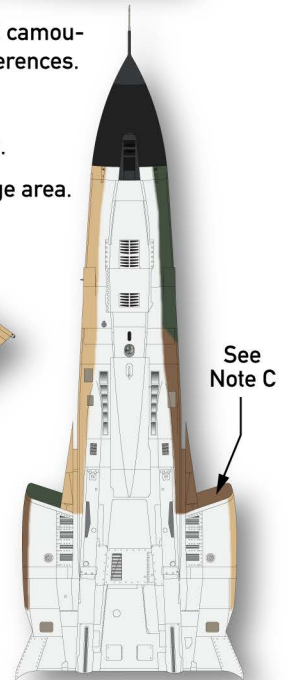

Iranian Camouflage



Left: F-4D-35-MC 67-14870 (3-602) delivered 4 Sep 68. Iran became one of the major export customers for the F-4, and the only non-US customer for new build F-4Ds. Most were delivered with 'slick' radomes, and all were finished in the "Asia minor" camouflage scheme - unique among all F-4 users.

Right: IIAF Commander-in-Chief Gen. Khatami climbs aboard F-4D-37-MC 68-6910 (3-623), delivered 7 Jul 69. Absolutely standard factory 'Asia Minor' camouflage and stencils. Note the very visible internal canopy fiberglass sealing strips.



Above: Iran's initial F-4E deliveries were -46 and -47-MC blocks with FY69 USAF serials, delivered between Mar and Nov 71. As such, these were all hard wing aircraft, and survivors were upgraded with slats in 1973-74. Many continue in service with the IRIAF today after having served for over 50 years and participated in at least two wars - the Dhofar War of 1973-76 in Oman and the Iran-Iraq war of 1980-88.

Right: Factory fresh F-4Es refuel from a U.S. Air Force KC-135A on their delivery flight to Iran in 1971. Iran's first F-4Es were among the first to get 'slime lights' installed on the production line.





Above: A glorious shot of a factory fresh IIAF aircraft on a pre-delivery test flight, wearing US insignias that were applied for the ferry flight to Iran. Note the TISEO pod finished in FS 30219, the black frame around the wing tip 'slime light', the 'salmon' slat warning stripes, and the FS 30219 walkway misted with the local camouflage colors - without the black outline. Trim decal as needed.

Above and right: two very pixelated JPG shots that are useful none the less, demonstrating both sides of the 'Asia Minor' camouflage pattern. There was considerable individual variation in the pattern on IIAF aircraft. Note the aircraft at right is missing the red turbine warning stripe, which was deleted on late IIAF deliveries as it was on USAF aircraft. Also note the camouflage colors misted over the hook warning placard.



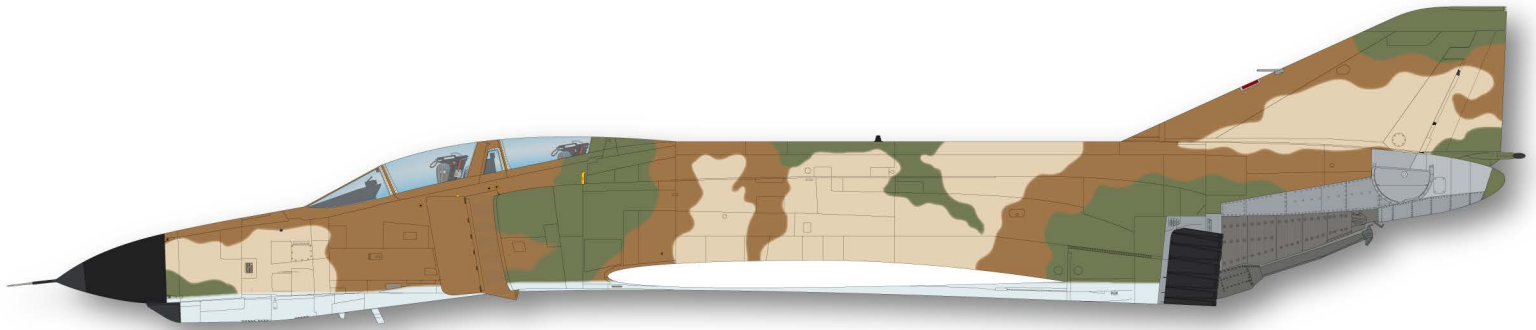

F-4E and RF-4E identical

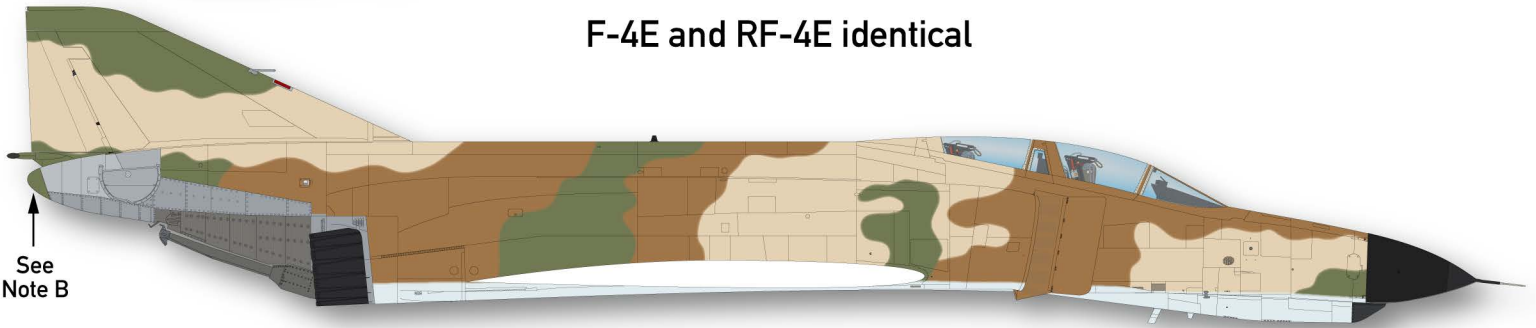

Notes:

B: The brake chute door is painted FS 34227.



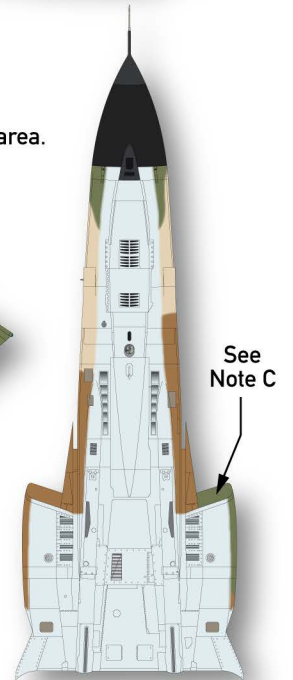
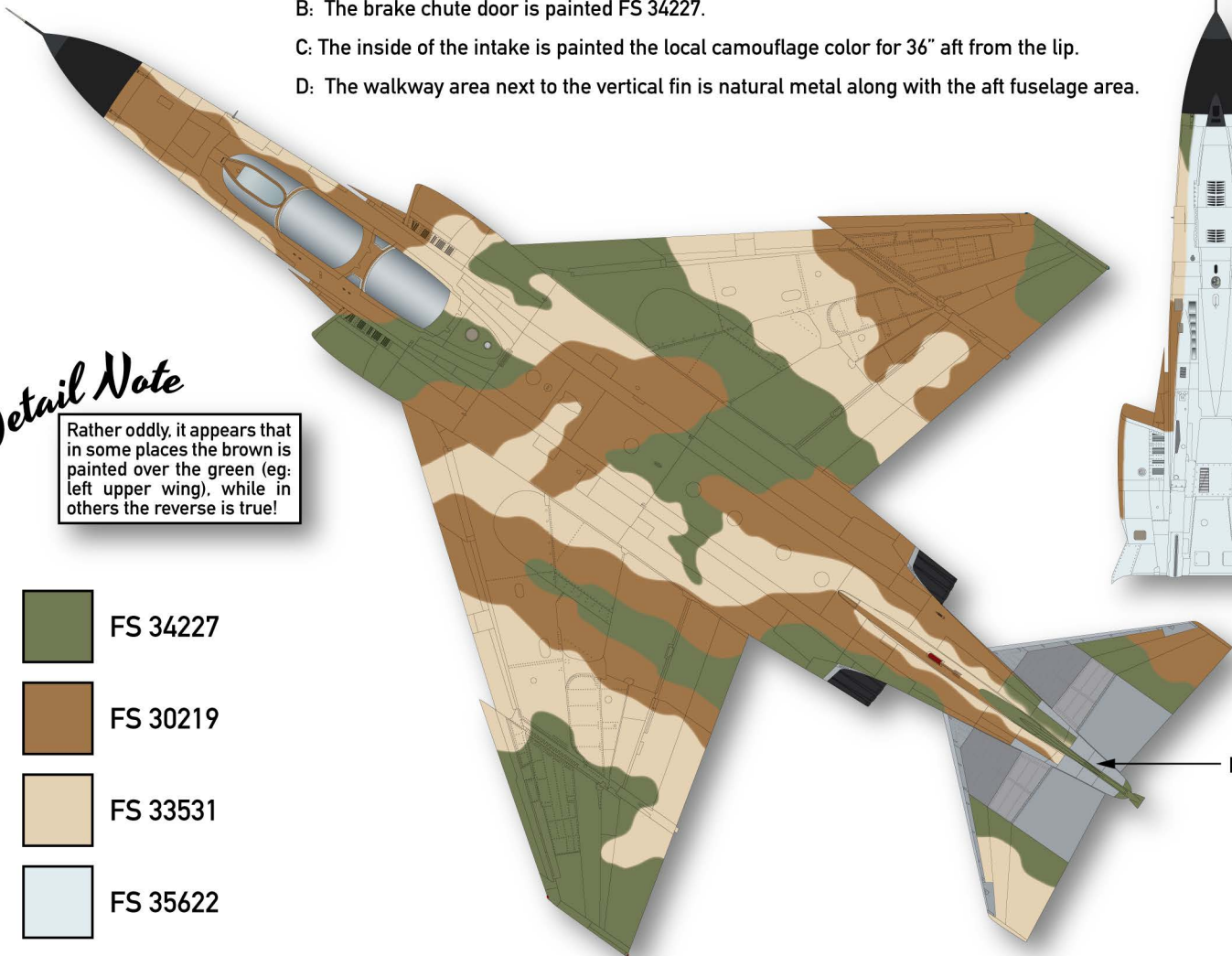

C: The inside of the intake is painted the local camouflage color for 36" aft from the lip.

D: The walkway area next to the vertical fin is natural metal along with the aft fuselage area.



Detail Note

Rather oddly, it appears that in some places the brown is painted over the green (eg. left upper wing), while in others the reverse is true!

-  FS 34227
-  FS 30219
-  FS 33531
-  FS 35622

Israeli Camouflage



Fündekals collection

F-4E-39-MC 68-0415 on the St. Louis ramp, destined for the Israeli Air Force under PEACE ECHO I. She was Israel's 6th Kurnass, delivered on 16 Oct 69. This and other period photos of Israeli aircraft lead us to believe that, again for reasons probably lost to history, IAF aircraft were painted with different paints than their USAF bretheren. The rich, saturated, almost chocolate brown color of the FS 30219 is typical of Israeli aircraft, while that on USAF aircraft delivered at the very same time was still the rather pale shade. Perhaps Israel specified a different vendor that cared more about color matching. Who knows, but the fact is, the "same" color on IAF and USAF aircraft is markedly different across dozens and dozens of photographs.

Basic Black...

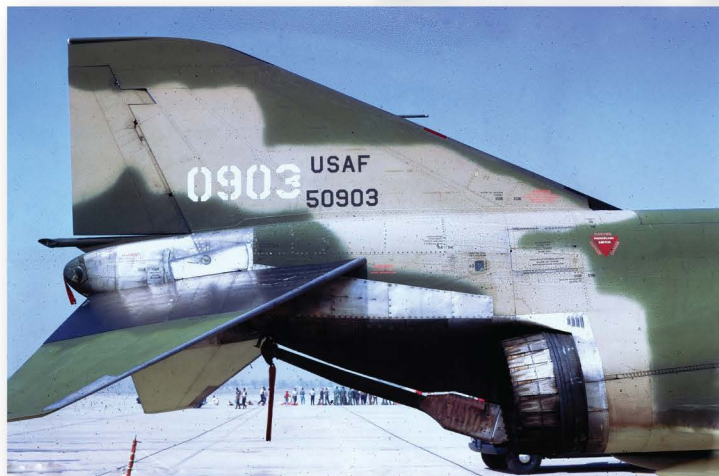

A great early shot of RF-4C-27-MC, 65-0903 showing the factory applied gloss black on the inboard halves of the stabilizers and the translating ring on the afterburner nozzle.

One of the 27 borrowed F-4Bs used by the 4453rd CCTS at MacDill in 1962-63, showing the black translating ring.



F-4D-32-MC 66-8775 in her factory paint, again illustrating the glossy black translating ring and inboard stabs.

Something that had escaped our notice prior to this project was the black painted translating afterburner nozzle ring (forward of the petals). On all new J79s installed on new F-4s the ring was glossy black, right from the very first J79-GE-1s installed in the prototype F4H-1s. When you start looking for it, it's there every time. As the ring moved back and forth, it sometimes got scraped up, and sometimes the paint would flake off, but the paint was there. This carried forward through F4H-1/F-4B production, as well as on all USAF "short burner" aircraft (F-4C, D, and RF-4C) until at least the early 1970s.

Then we started noticing aircraft with glossy black inboard stabilizers - wait, what? A lot of research later, we're pretty confident in saying that (almost*) all F-4Ds and RF-4Cs beginning with Block 26 (the first FY65 serials), as well as all F-4Es up through somewhere around the end of Block 44 (FY69 serials) had glossy black inboard stabs. Iranian F-4Ds (at least the Block 33 aircraft we have seen period photos of) also had black inboard stabs, as did the Australian Block 43 F-4Es. We have found no instance of a Navy F-4 with black inboard stabs.

So then we started looking at Navy airplanes and F-4Es with the long burner nozzles. And we saw glossy black everywhere on new F-4Es and Js. For certain, all Js were finished that way up to the last one built in late 1971, and all Es were finished that way up into the 1972 production blocks. We can't positively identify when they stopped painting the burner nozzles, but later F-4Es in the FY72 and later blocks had bare metal exhausts.

As a general rule, the glossy black went away after depot overhaul, but not in every case. And we believe that the contract depot facility at Getafe in Spain actually applied glossy black to the inboard stabs on at least some overhauls well into the 1970s! In short - now that you know what to look for, build what you see in the photos!

* As usual, you can find exceptions to every rule. We've found a small handful that appear not to have been painted, or that may have been stripped early on.

Basic Black...



A pair of RF-4Cs showing the black inboard stabs.



Two F-4Ds, one Iranian and one American. On F-4D-30-MC 66-7509 note how the black paint is chipped off on the inboard stab.



Basic Black...



Two shots of early build (153777) and late build (158370) F-4Js. Note that the Navy never painted the inboard stabs glossy black, but the afterburner nozzles were.

Also note the Corogard paint above the stabs and on the drag chute door on early build F-4Js, with natural metal, with an FS 36440 drag chute door on later build aircraft.



Measure twice...



For reasons we will probably never know, McDonnell applied the national insignias on Southeast Asia camouflaged F-4s in a non-standard size. The USAF specified a 15" insignia for this scheme. This is often referred to as the "nominal" size of the insignia. Because of the way the current U.S. national insignia came into being before, during, and immediately after WWII, the nominal size of the insignia is measured using the diameter of the circle (D in the illustration above) that circumscribes the tips of the star that originally made up the roundel style insignia. Thus, while the outer border was added in 1943, increasing the overall diameter of the insignia, the convention of using the diameter of the inner circle was (and still is) used to denote the nominal size of the insignia.

When McDonnell interpreted the new requirement for a smaller insignia, they mistakenly (?) made the inner circle the size of the outer

circle on a 15" nominal insignia. We'll save you the math, but it turns out that figure is 16.79". So McDonnell's non-standard insignia came out to 18.89" overall, or 12.5% too large! The unique McDonnell style borderless insignia applied to the upper surfaces of factory camouflaged F-4s was designed to this same incorrect size.

If you've made the mistake, but you've already ordered tens of thousands of decals and it's too late to change it, you go with what you've got, and hope the customer doesn't notice. If the USAF did notice, they clearly didn't care, since all USAF and foreign F-4s delivered from late 1965 until the end of production in 1979 had these same oddball size insignias.

We have not seen any depot repaints that got these insignias. Those were invariably standard size 15" insignias, and almost always had the outer blue border in all four positions.

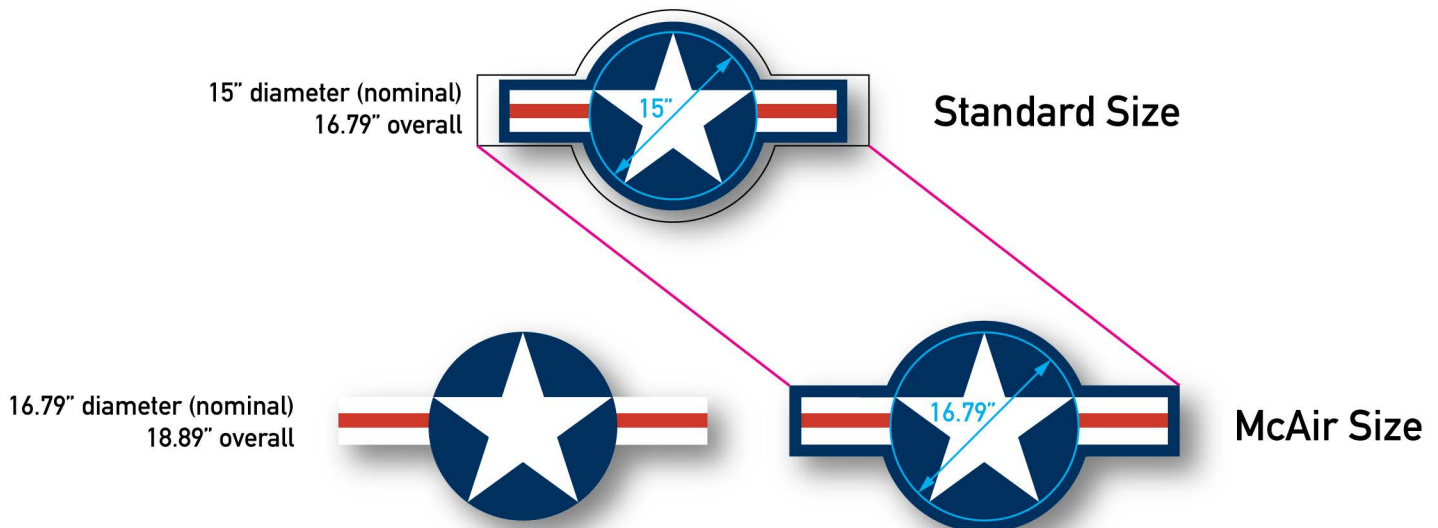

From Chaos... Order!

Let's face it: this *might* not be a fun job. But take heart! We pondered over how to make it as painless as possible. Part of that is organizing the instructions in a logical order and in small pieces. But then it came to the actual decal. So here's what we came up with. When you have decided on what variant(s) of the Phantom you will be building, locate that section of the instruction sheet. We recommend printing those pages out so you can check off individual items as you apply them. When you're ready, cut off one strip of sequentially numbered decals as shown below. Then remove one (and only one!) decal at a time, apply it, and mark it off the instructions as you go. Continue to the end of the strip, stop, have a glass or two of your favorite libation, then cut and apply another strip. Slow and steady wins the race, and before long your Phantom will be stenciled!

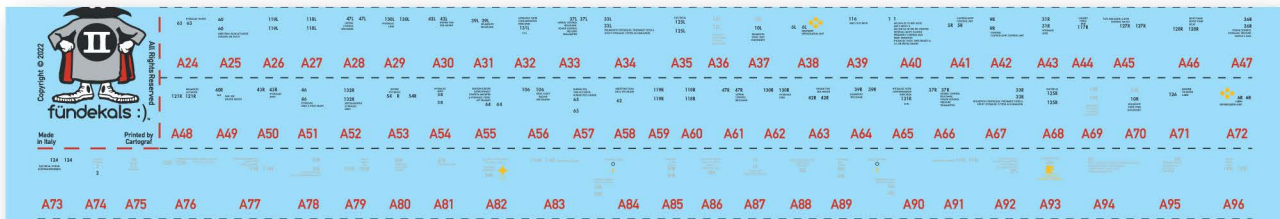
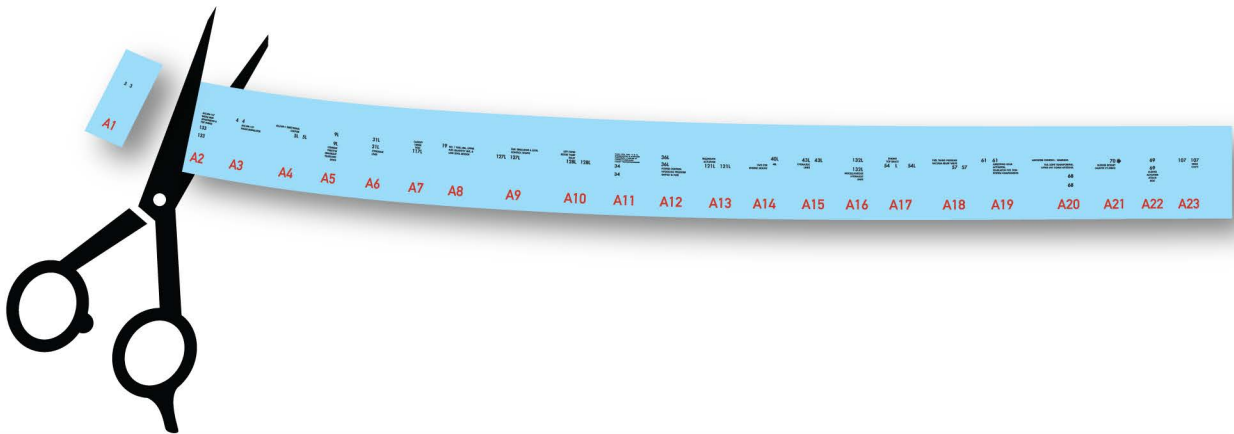

IMPORTANT NOTE!

Be sure to apply the major markings, including national insignias, NAVY/MARINES titles, and U.S. AIR FORCE/USAF titles **before** applying stencil markings! Many stencil markings overlie these major markings. Carefully note the exact positions of the major markings relative to panel lines and other airframe landmarks and apply them precisely as shown, otherwise certain stencil markings will not lay on them correctly.

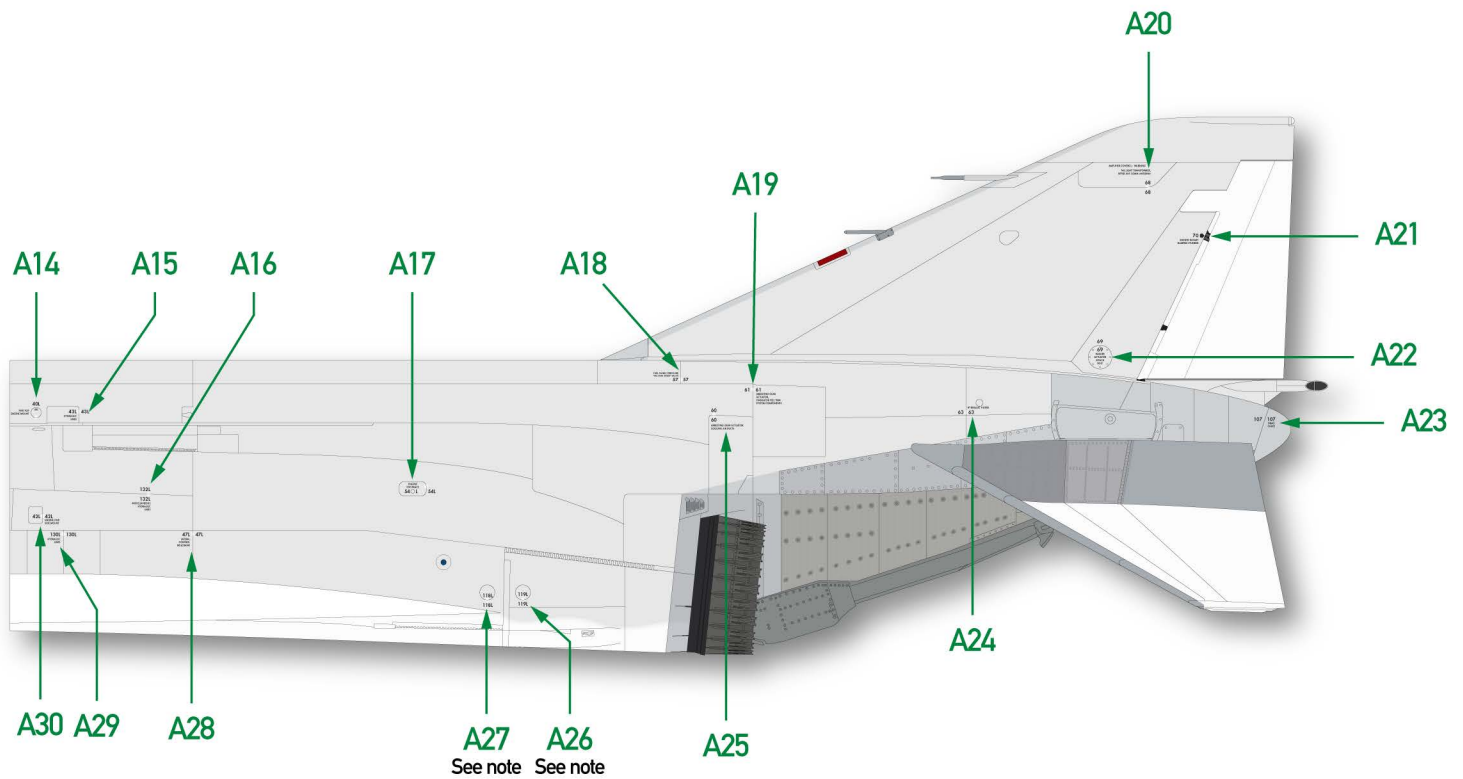
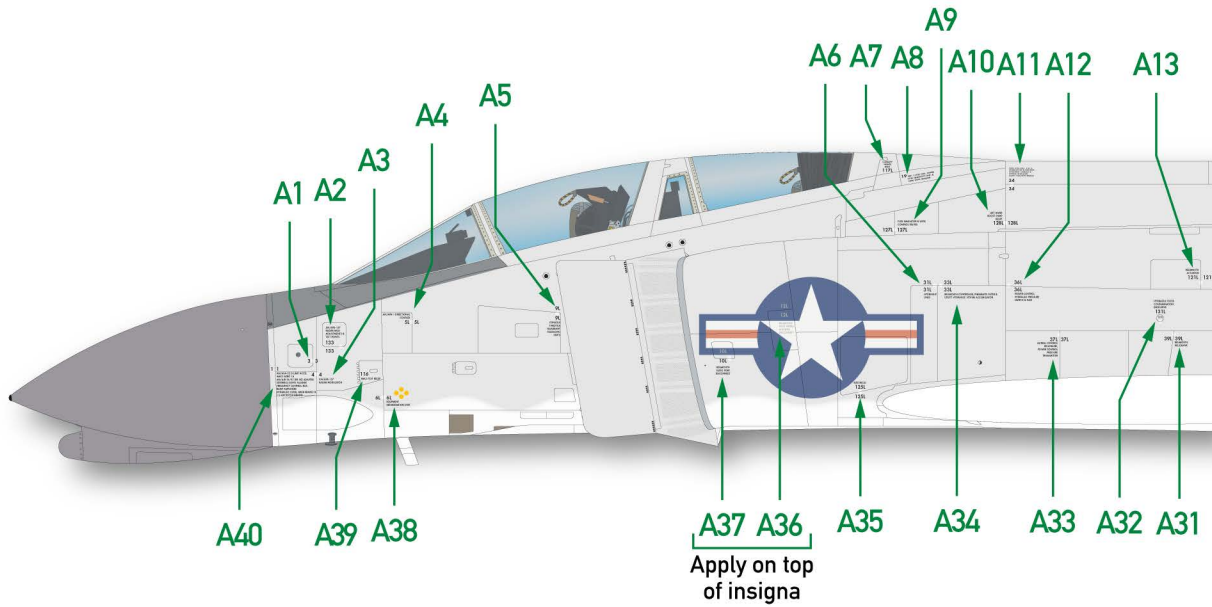

Note: Decals A26 and A27 may be positioned at the top or the bottom of the round access panels, depending on whether the taller "NAVY" or shorter "MARINES" titles were applied. Most F-4Bs, even those that were delivered directly to USMC units, left the factory with "NAVY" applied, with these items positioned as shown.

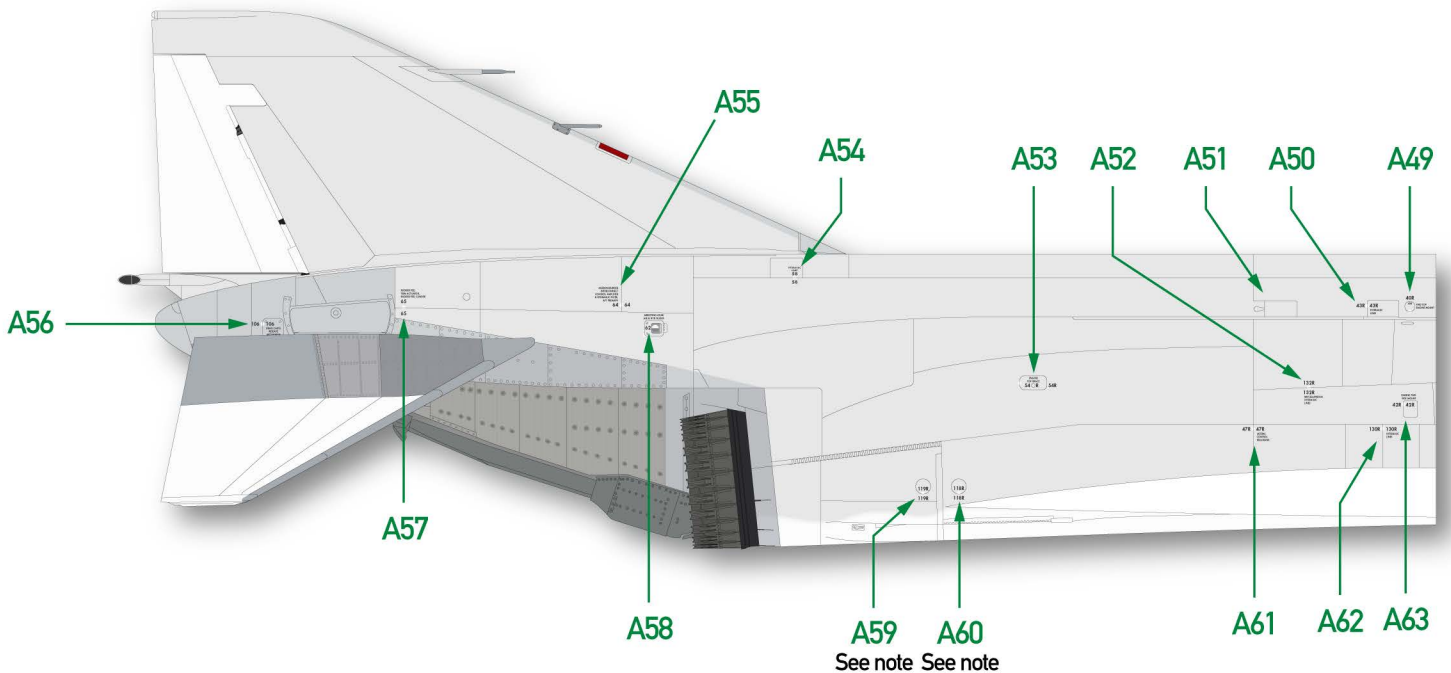
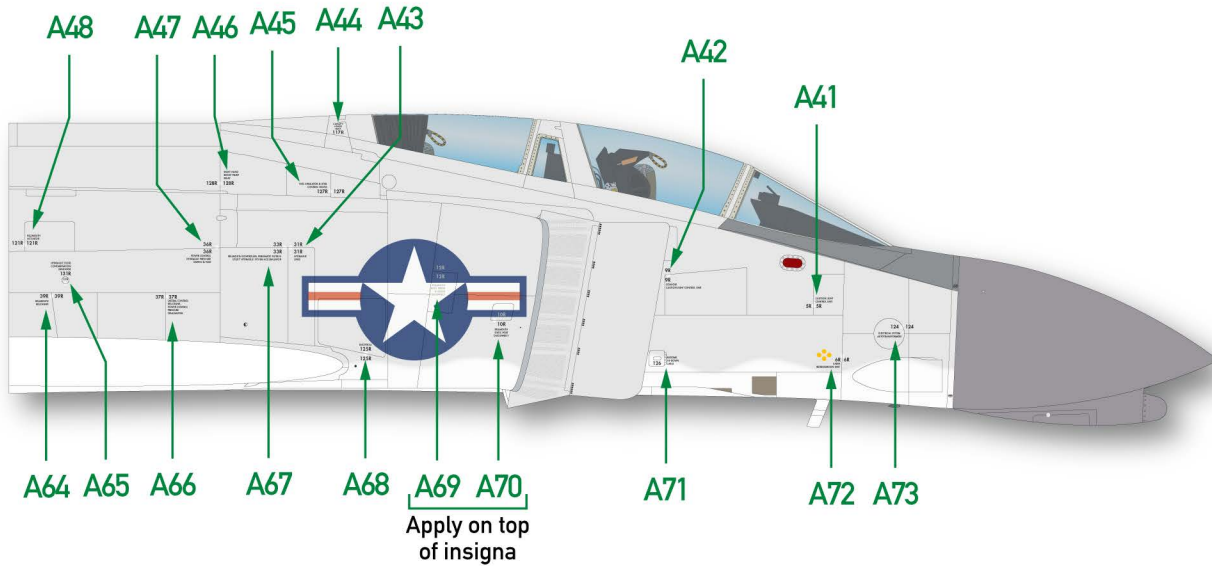

Note: Decals A59 and A60 may be positioned at the top or the bottom of the round access panels, depending on whether the taller "NAVY" or shorter "MARINES" titles were applied. Most F-4Bs, even those that were delivered directly to USMC units, left the factory with "NAVY" applied, with these items positioned as shown.

Early production blocks

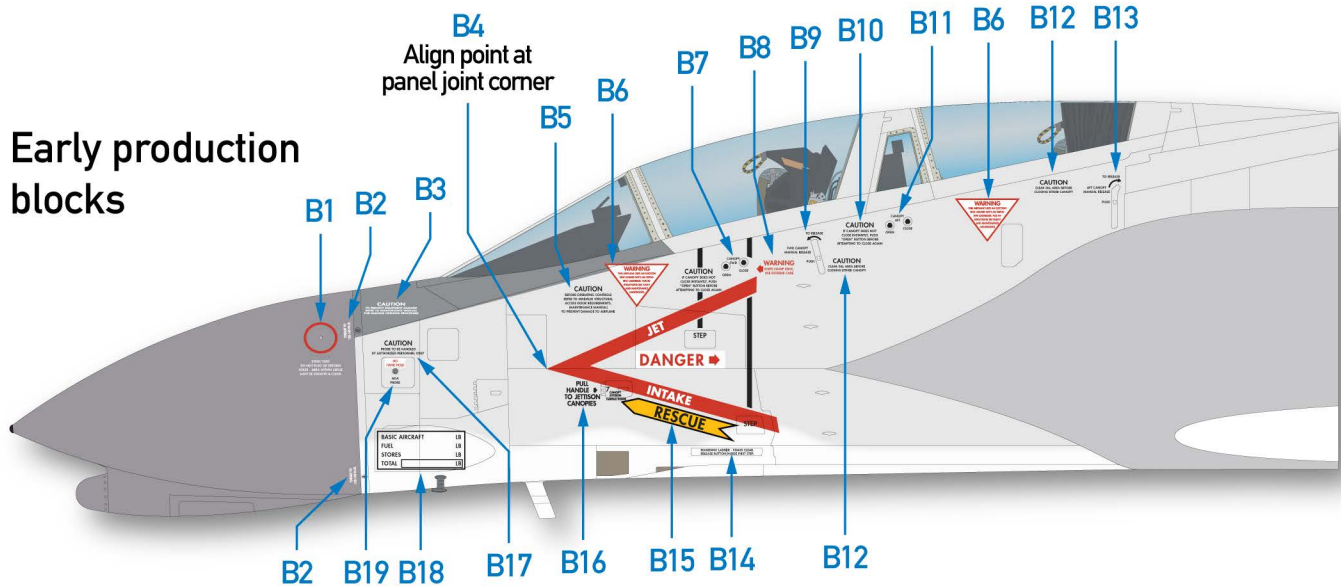

Late production blocks

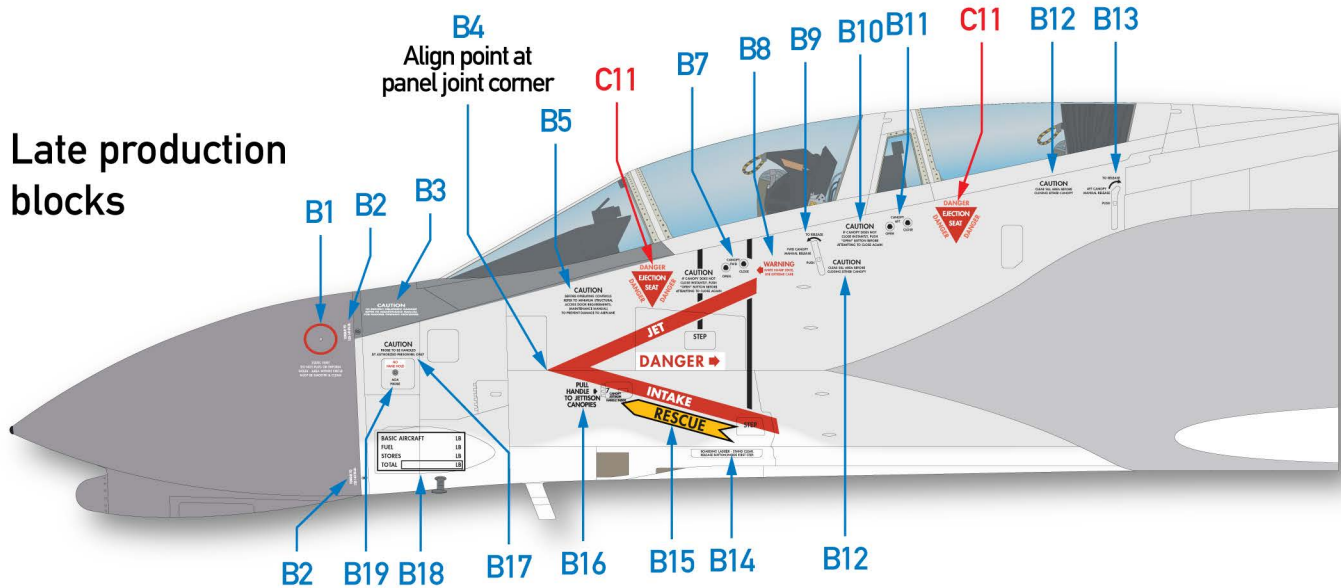

Notes:

C11: The white-on-red (USAF style) ejection warning triangle was introduced in January 1966 from Block 25 onwards (BuNo 152965). Older aircraft retained the earlier style until depot overhaul.

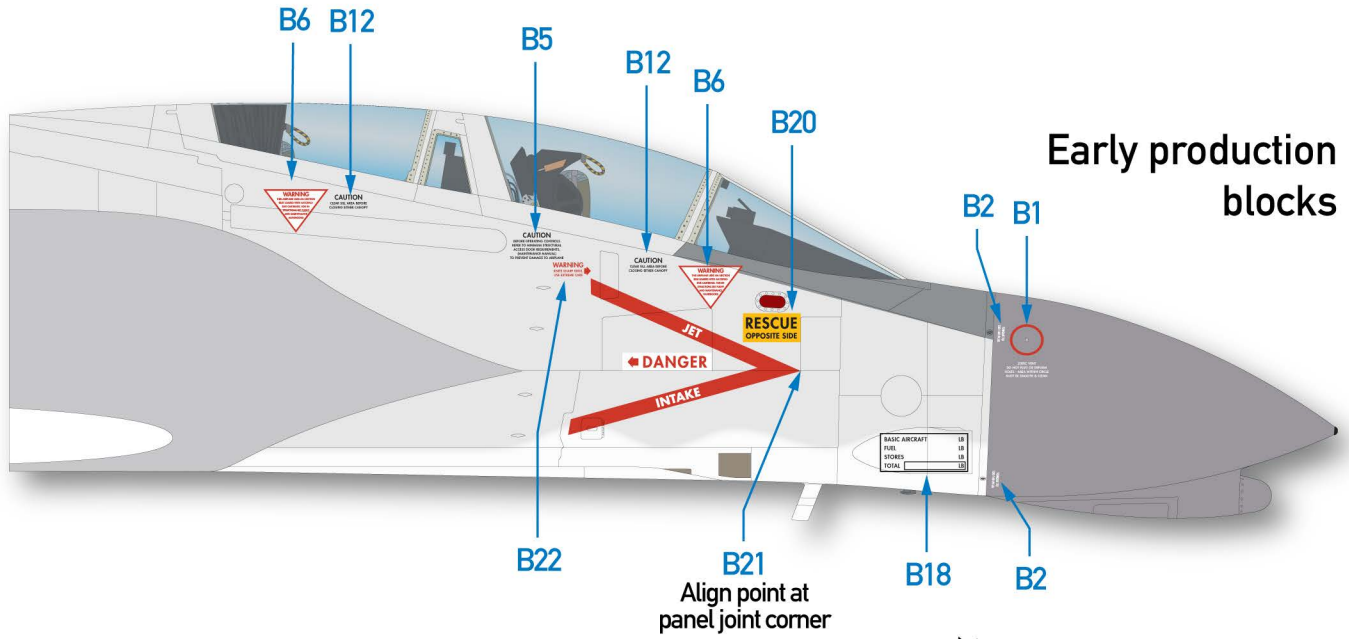

Detail Note

The red refueling probe illumination light was fitted on the production line starting with Block 8 F4H-1s (BuNo 148411). It was retrofitted to earlier aircraft during depot overhaul.

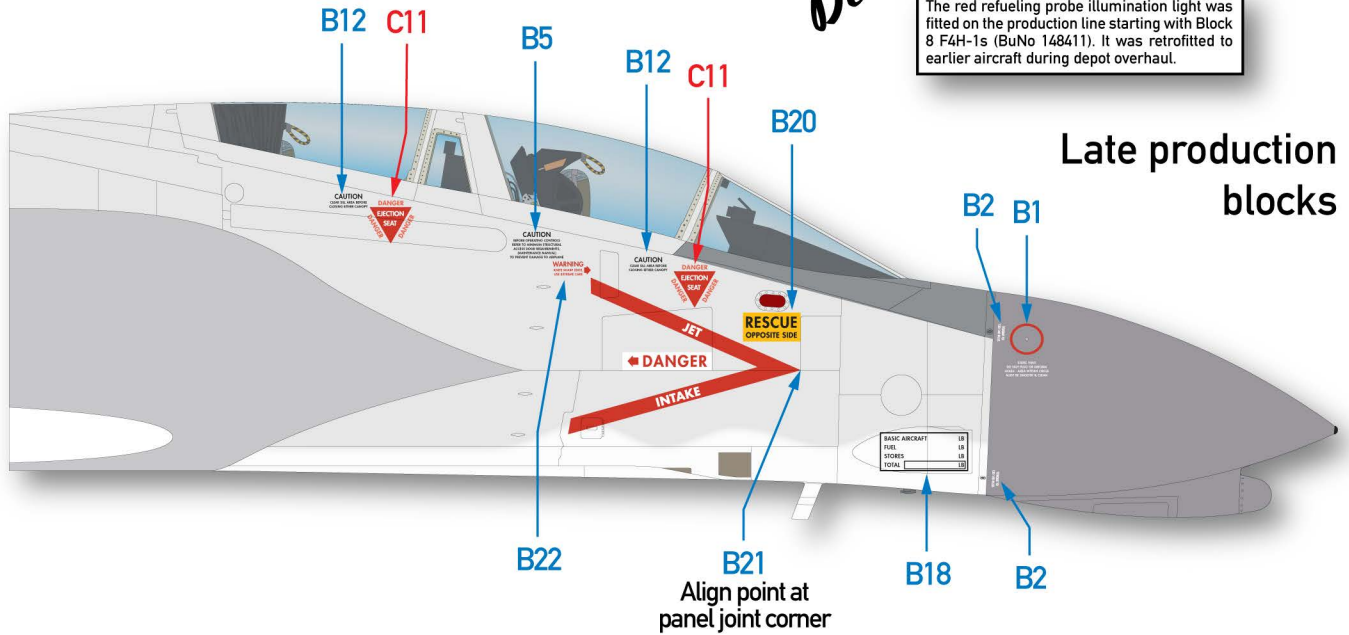

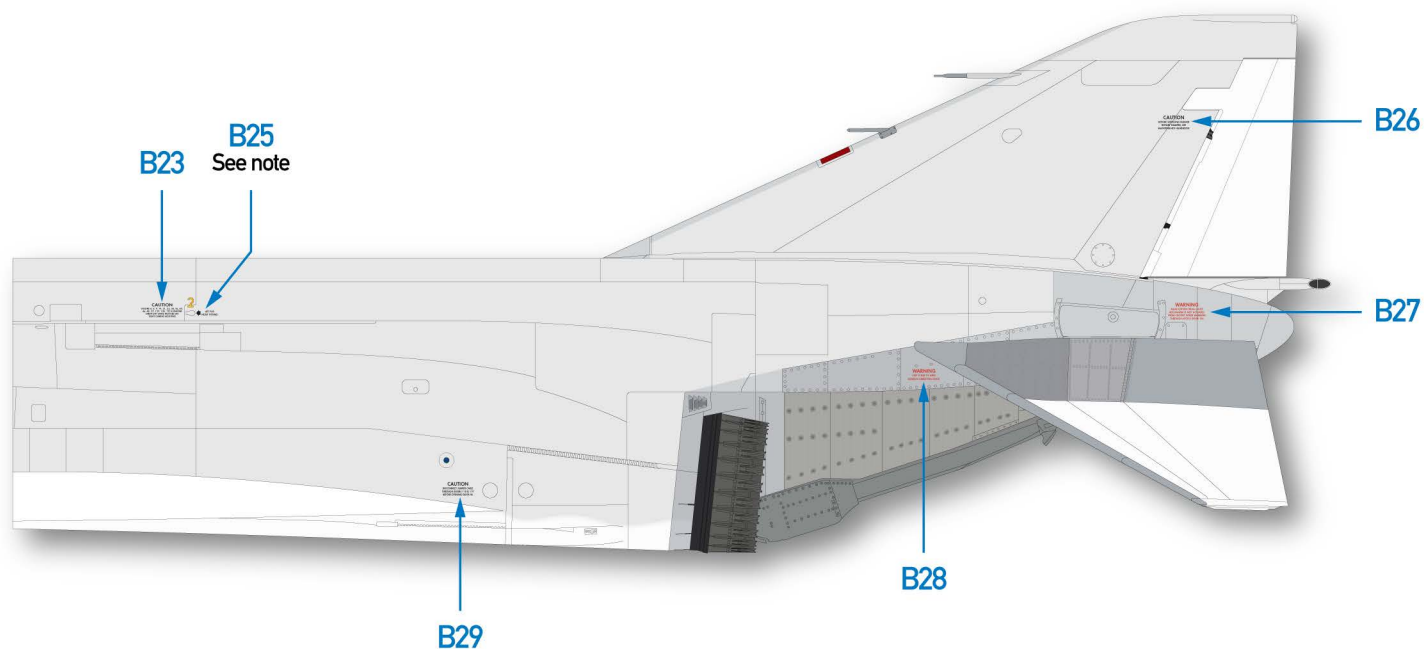
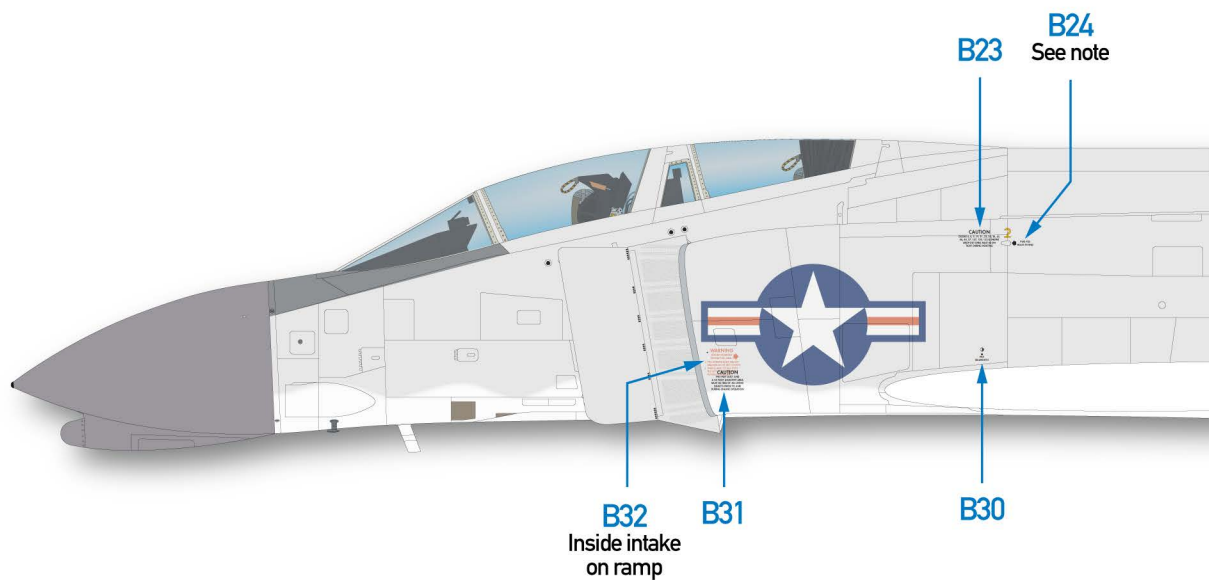

Note: On decals B24 and B25, the yellow hoisting hook symbol was not present on early F4H-1s and F-4Bs. It appeared sometime around 1965, but we have not been able to determine a precise production block or BuNo for its implementation. Trim the symbol off if you are building an early Phantom.

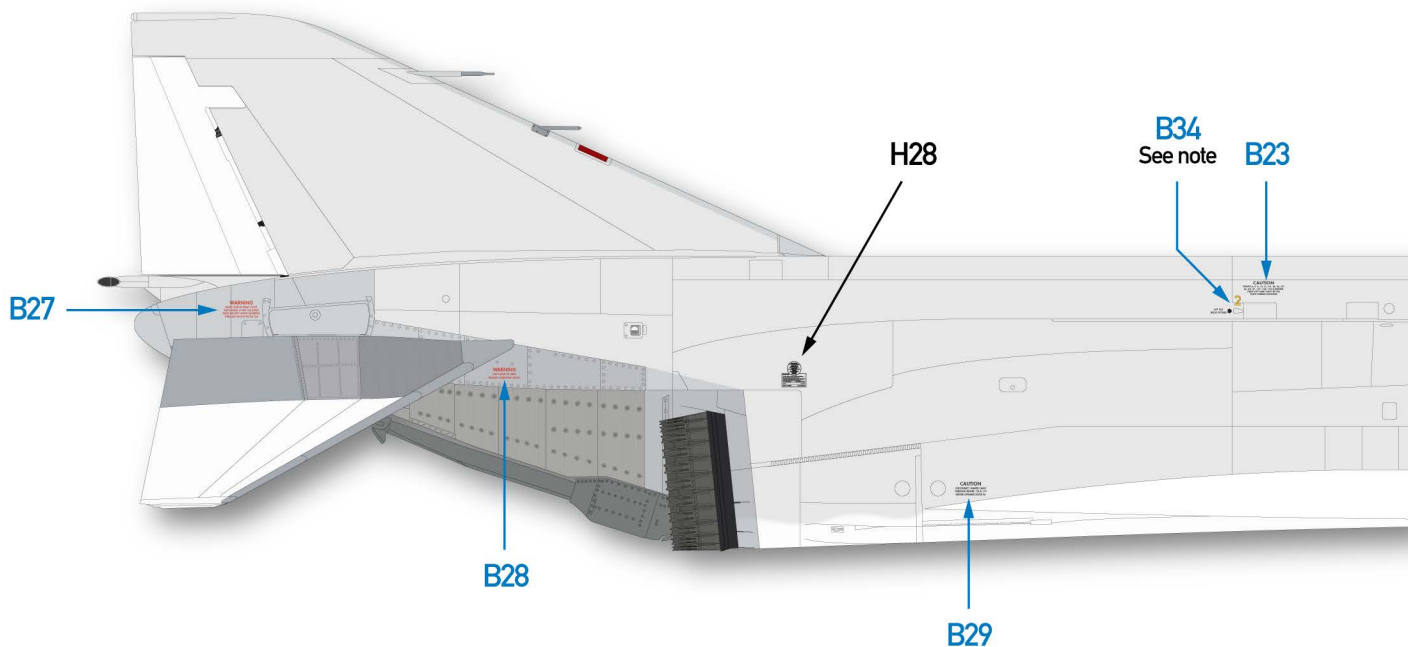
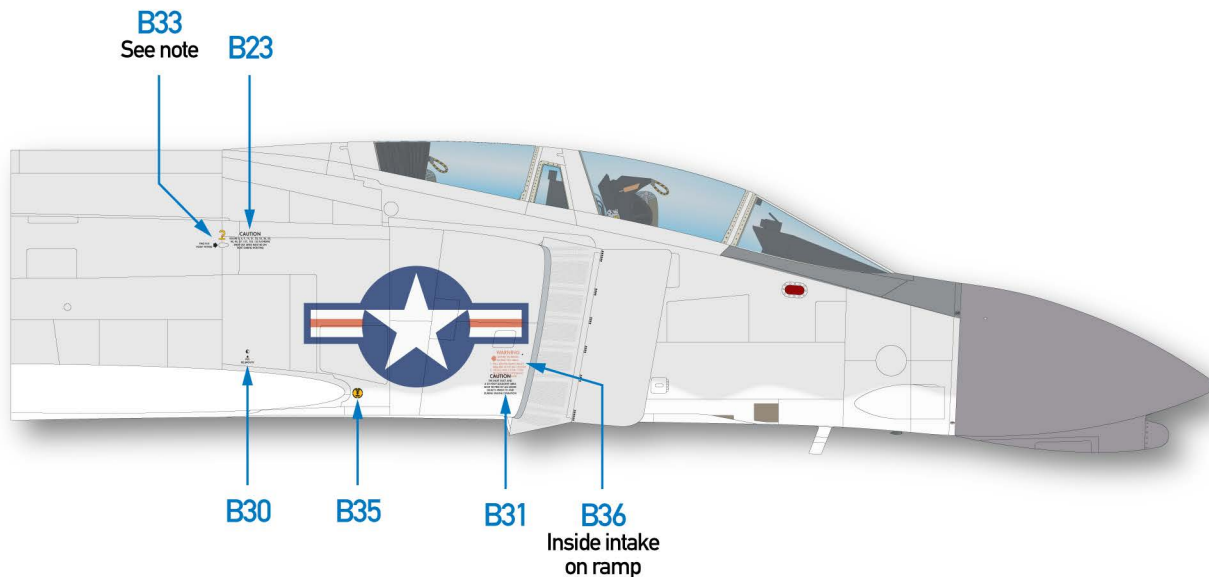

Note: On decals B33 and B34, the yellow hoisting hook symbol was not present on early F4H-1s and F-4Bs. It appeared sometime around 1965, but we have not been able to determine a precise production block or BuNo for its implementation. Trim the symbol off if you are building an early Phantom.

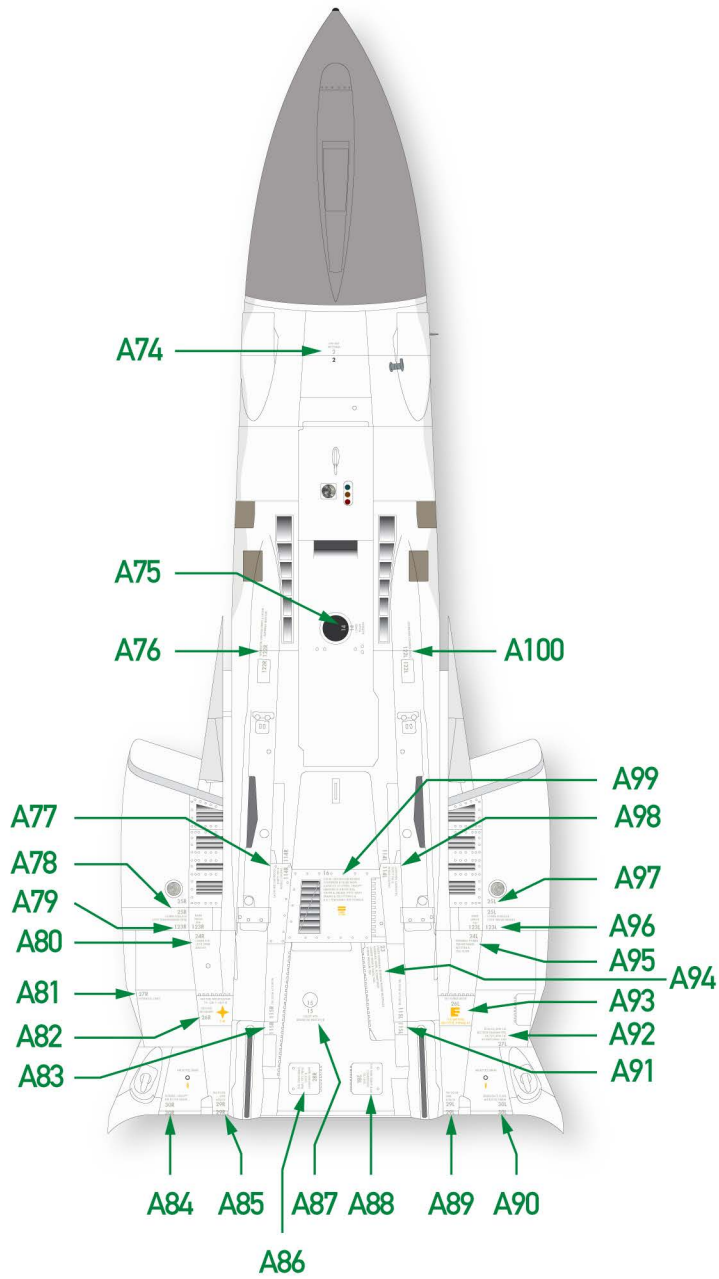

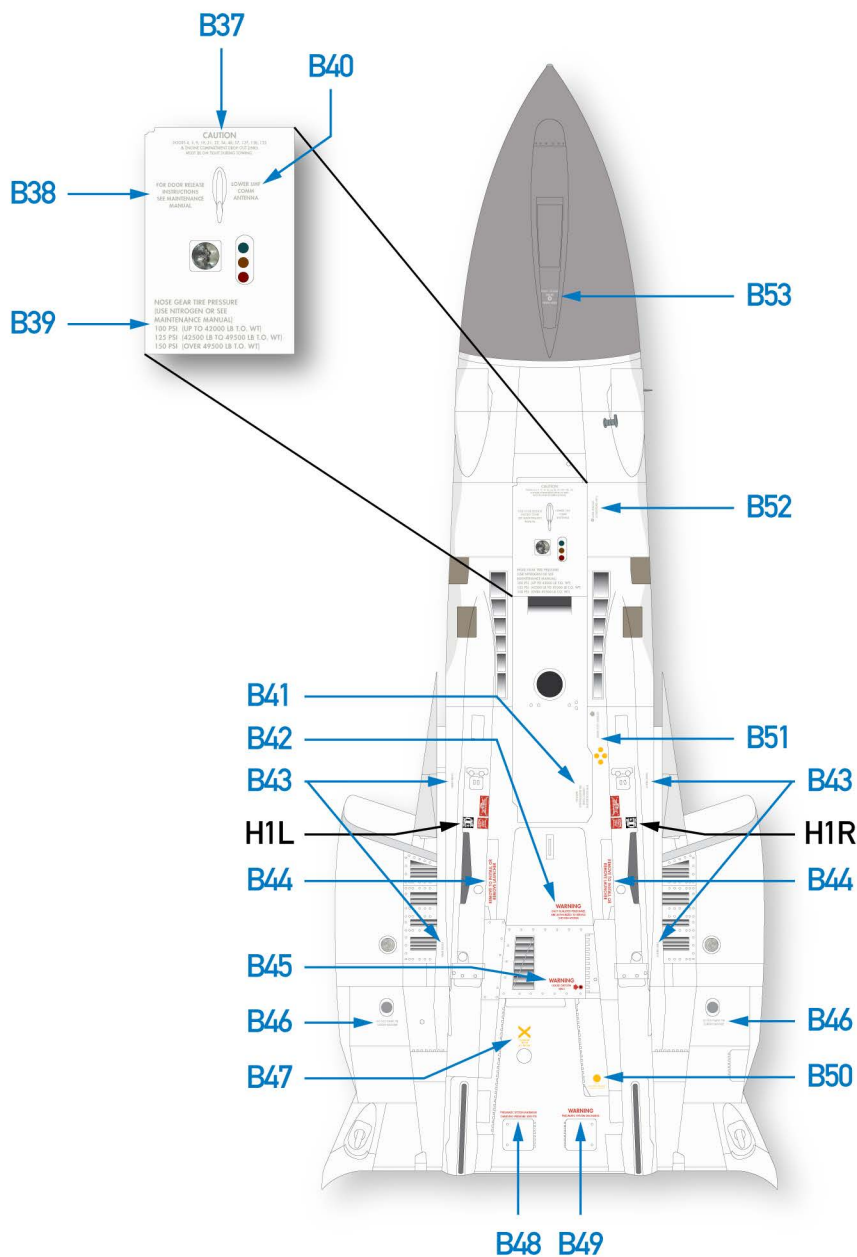

↑
Forward

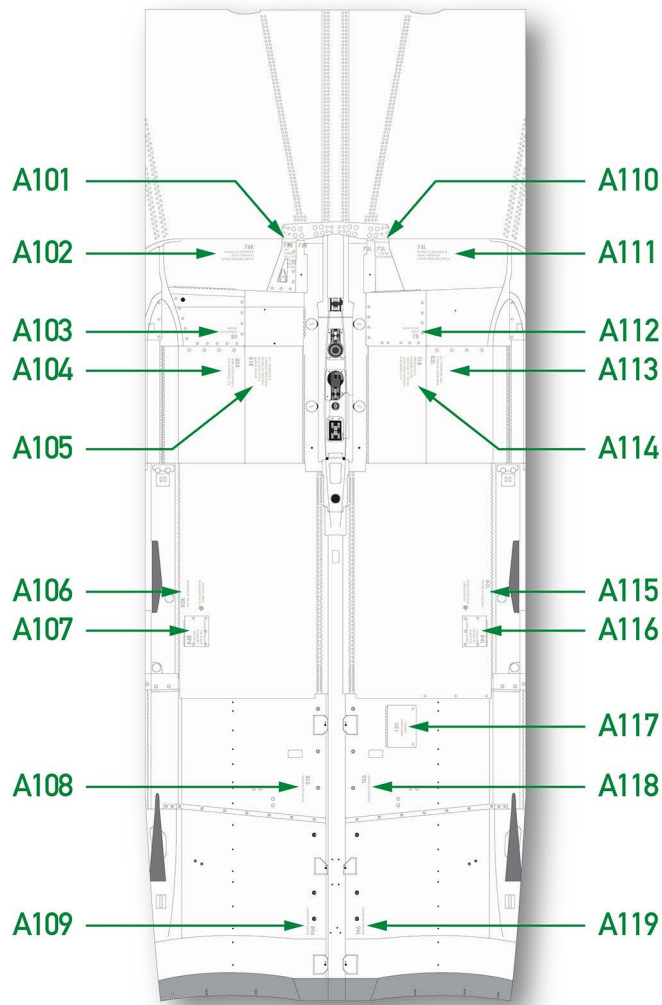

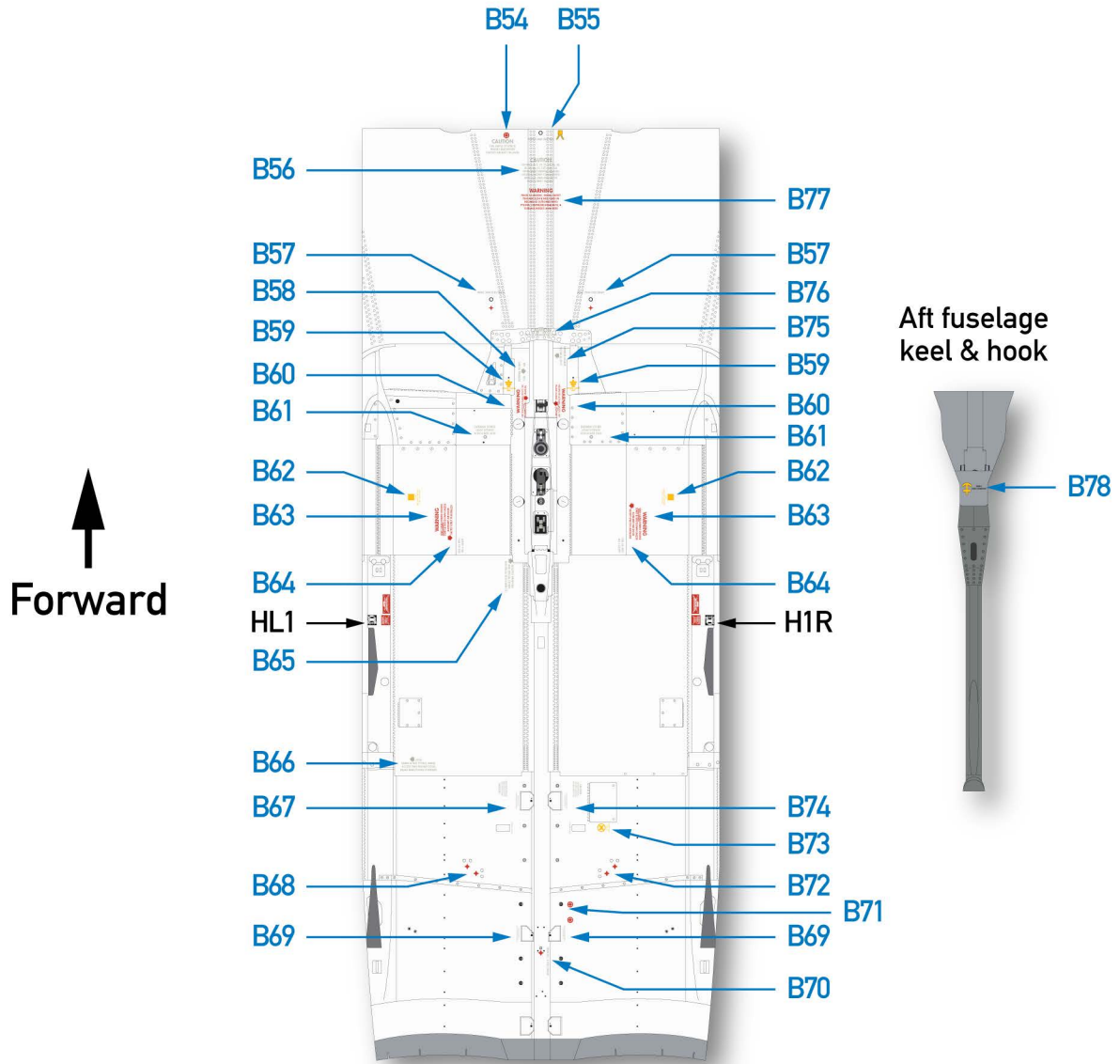

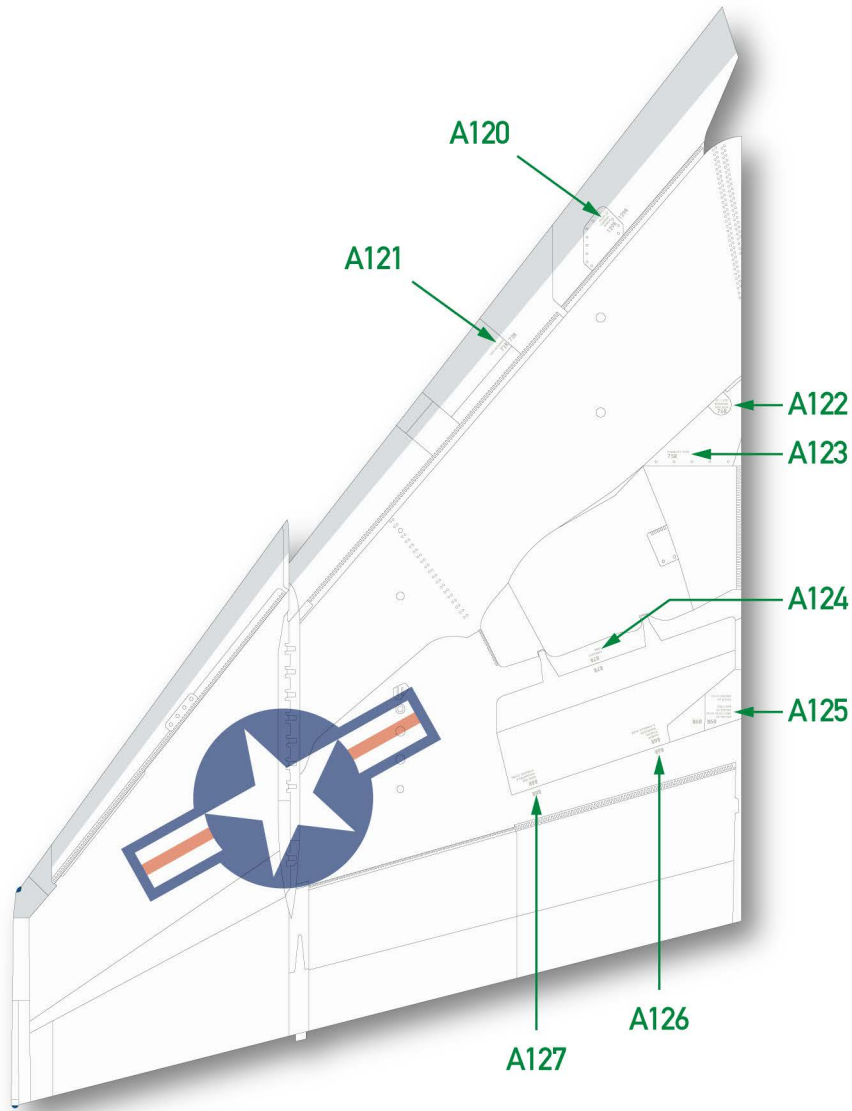

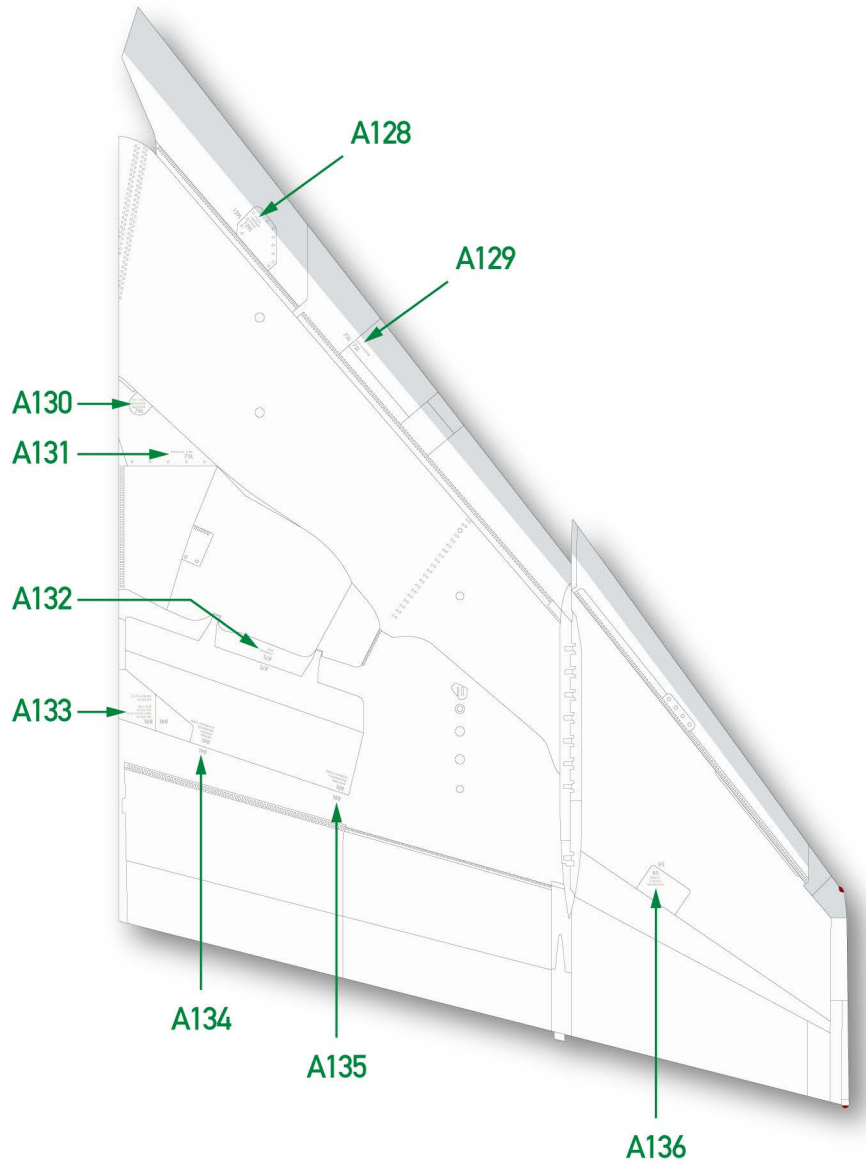

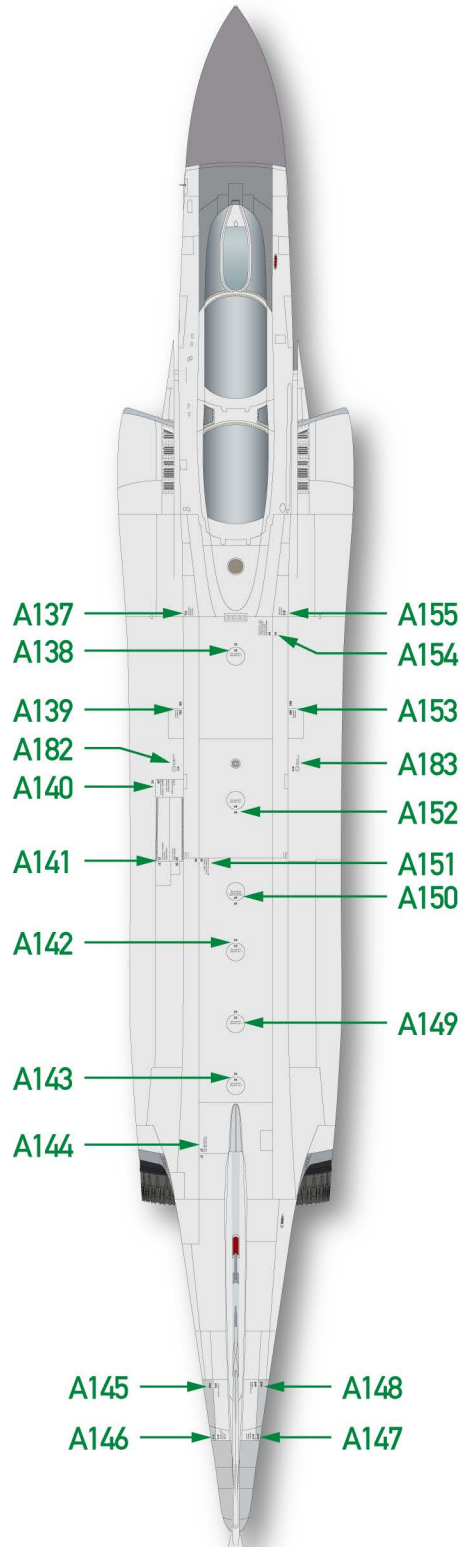

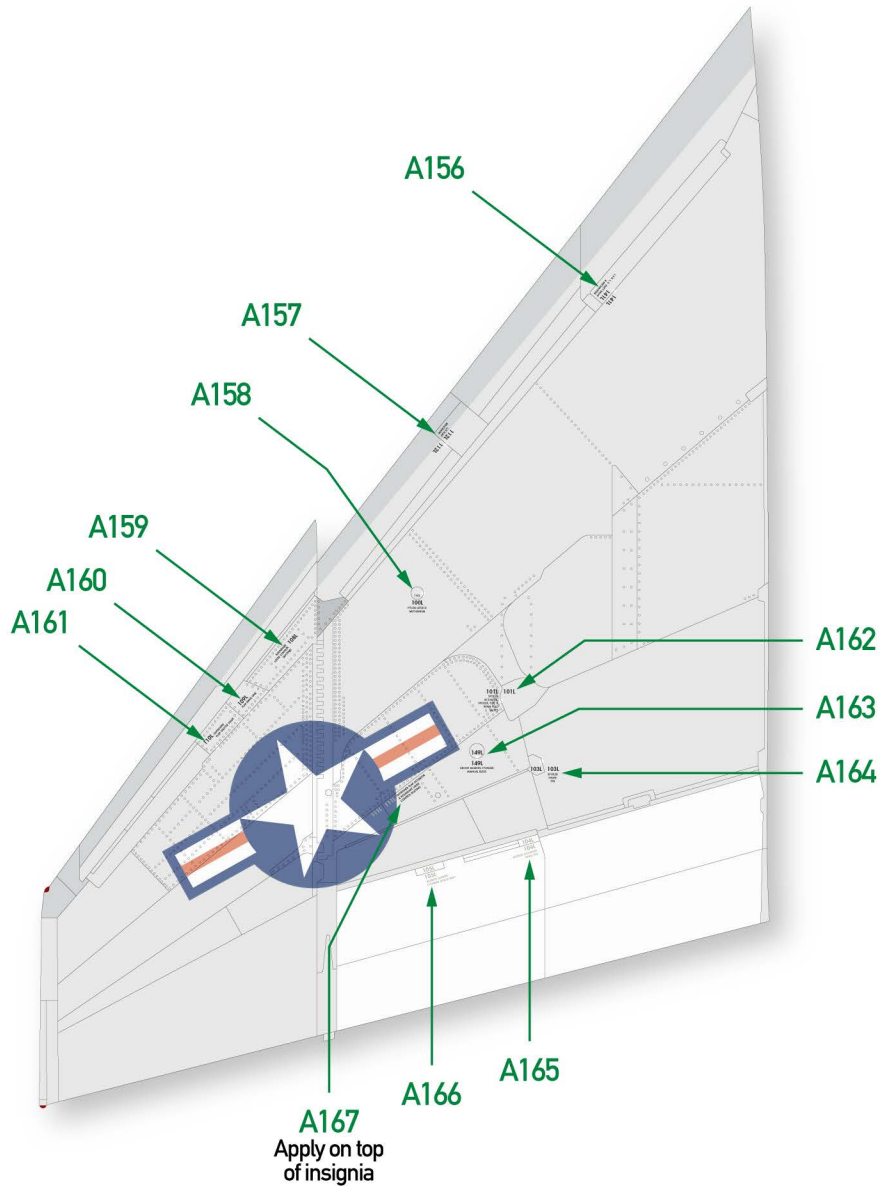

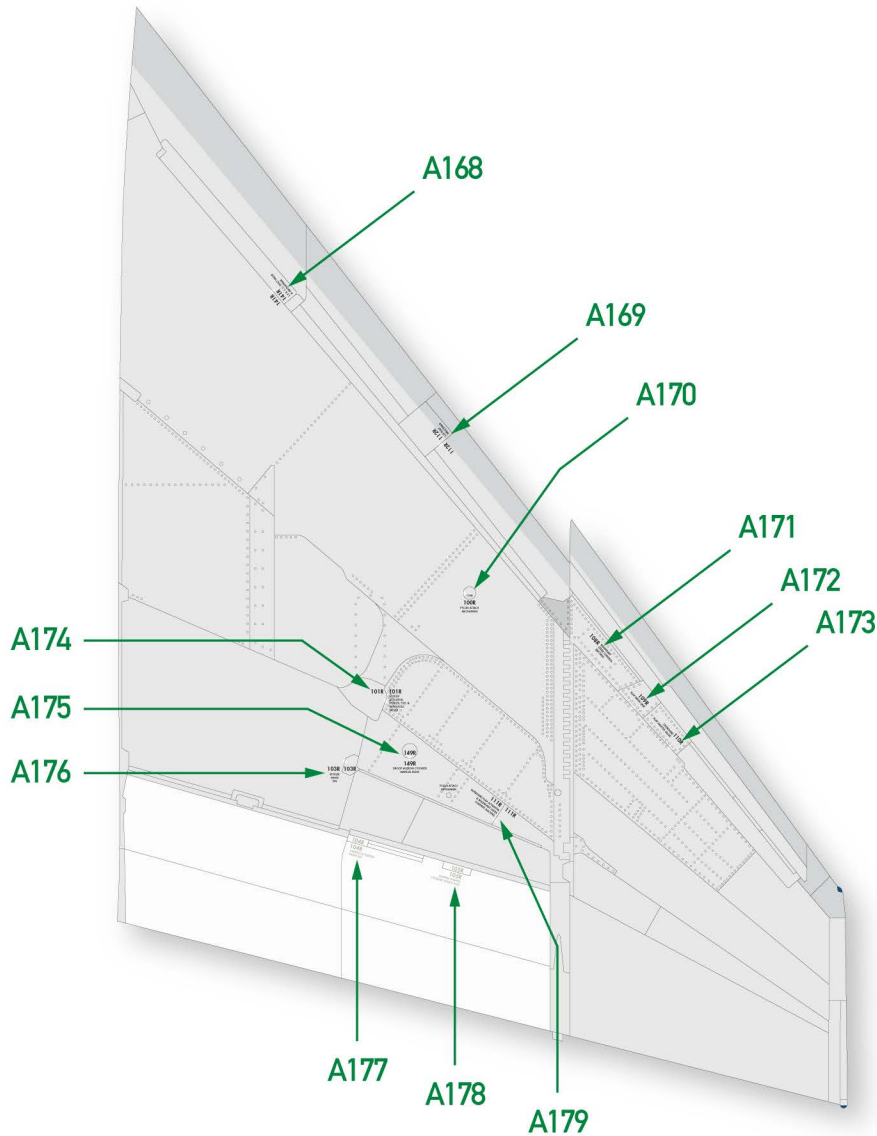

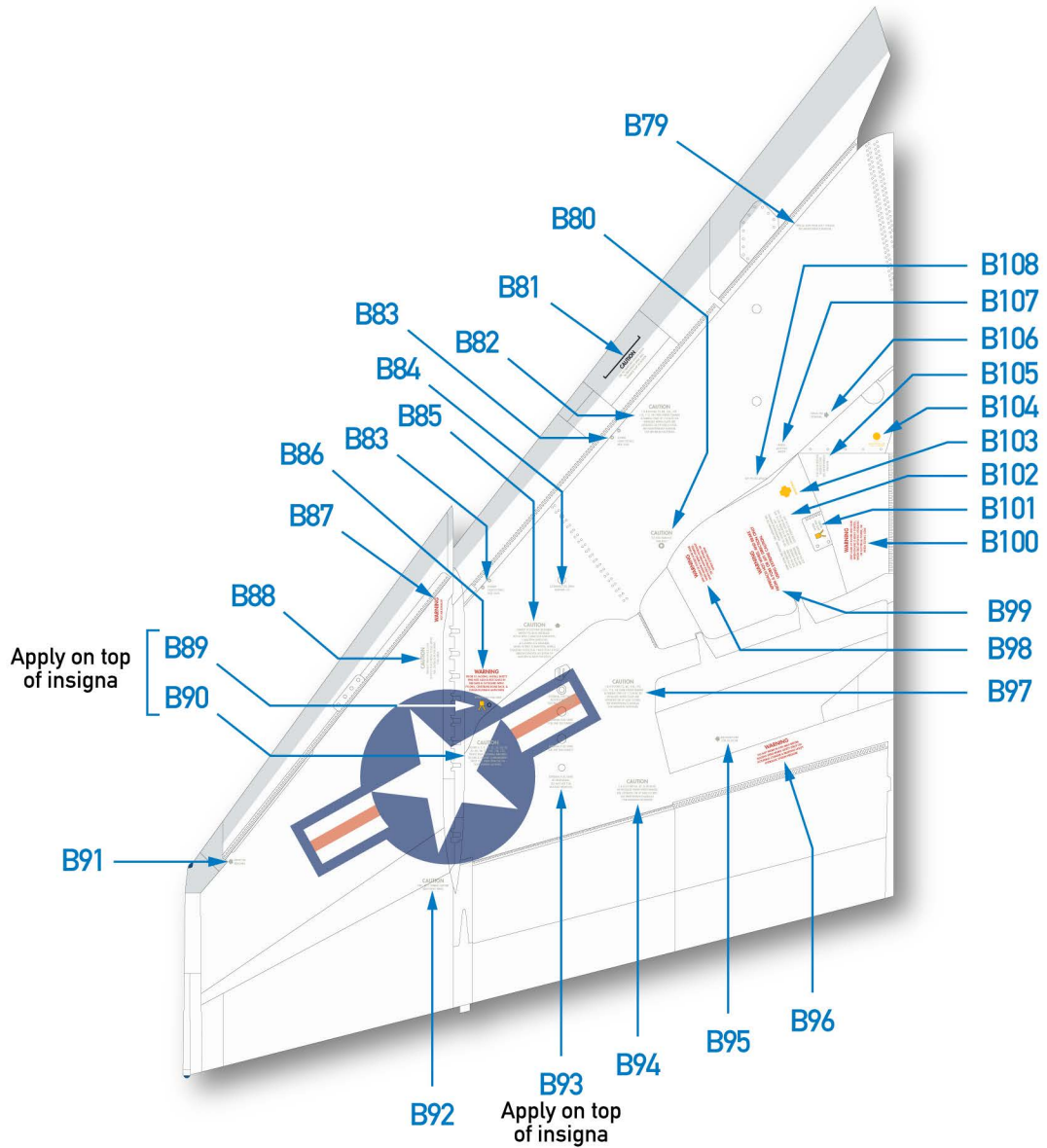

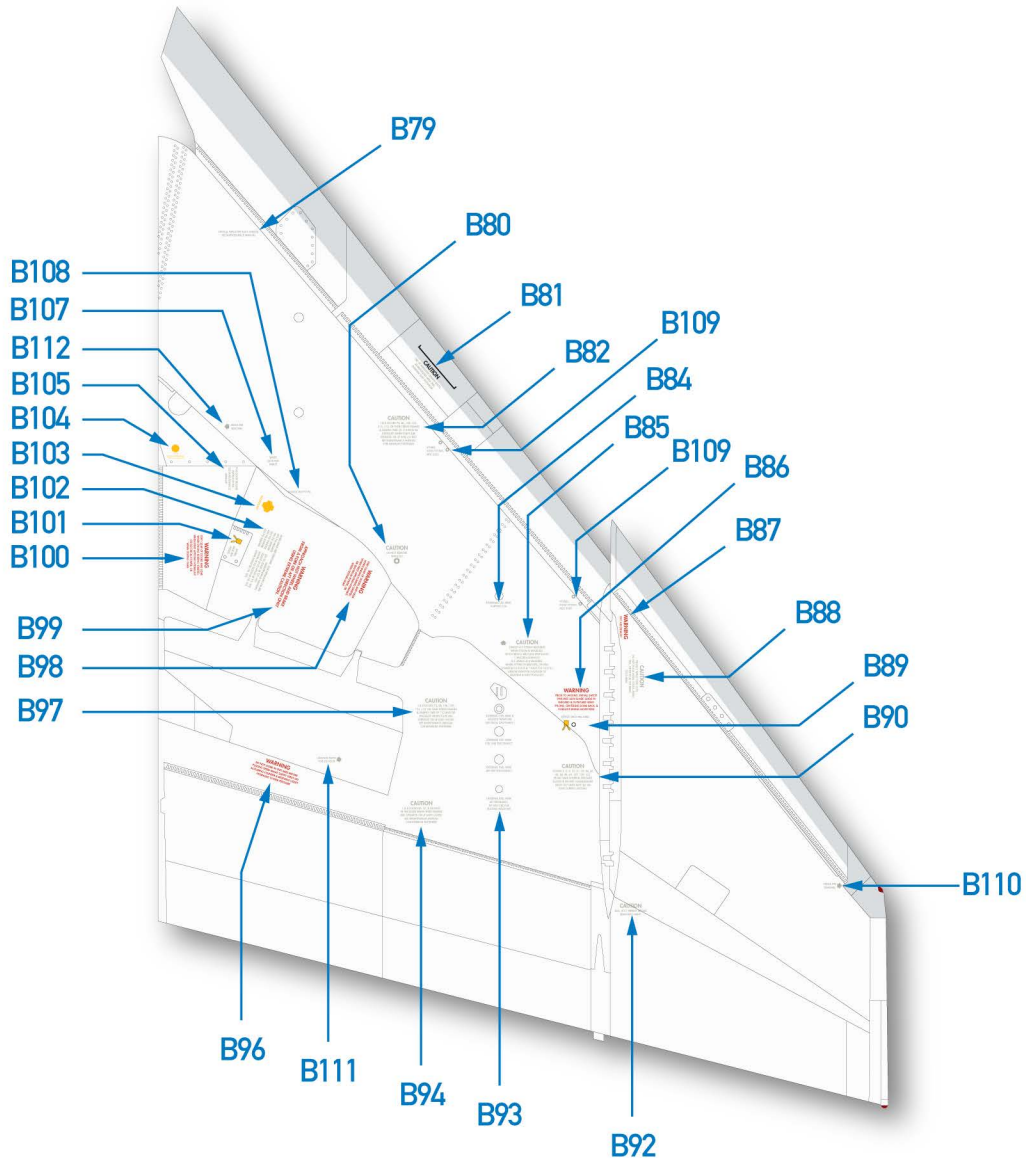

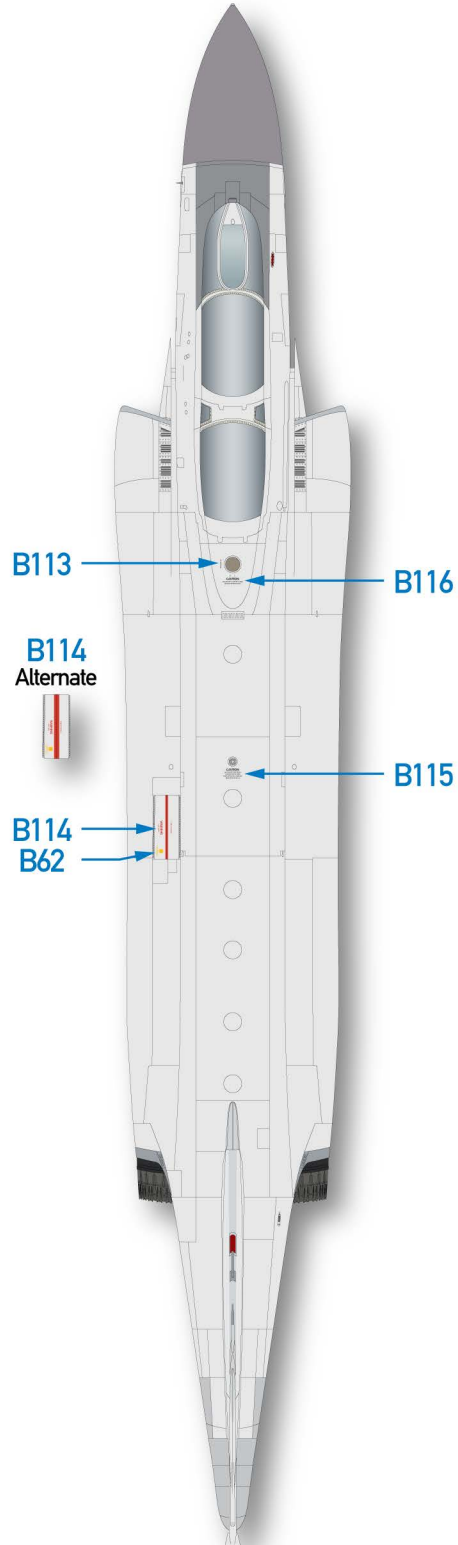

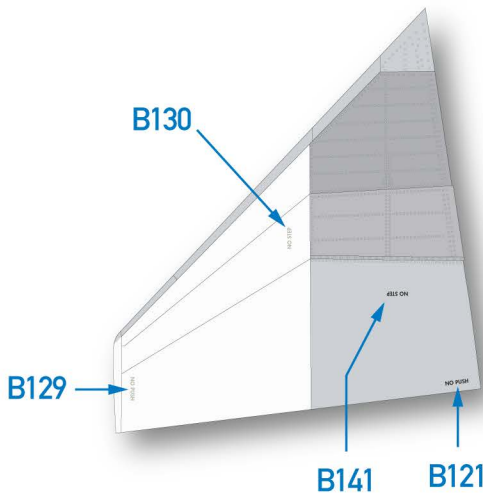
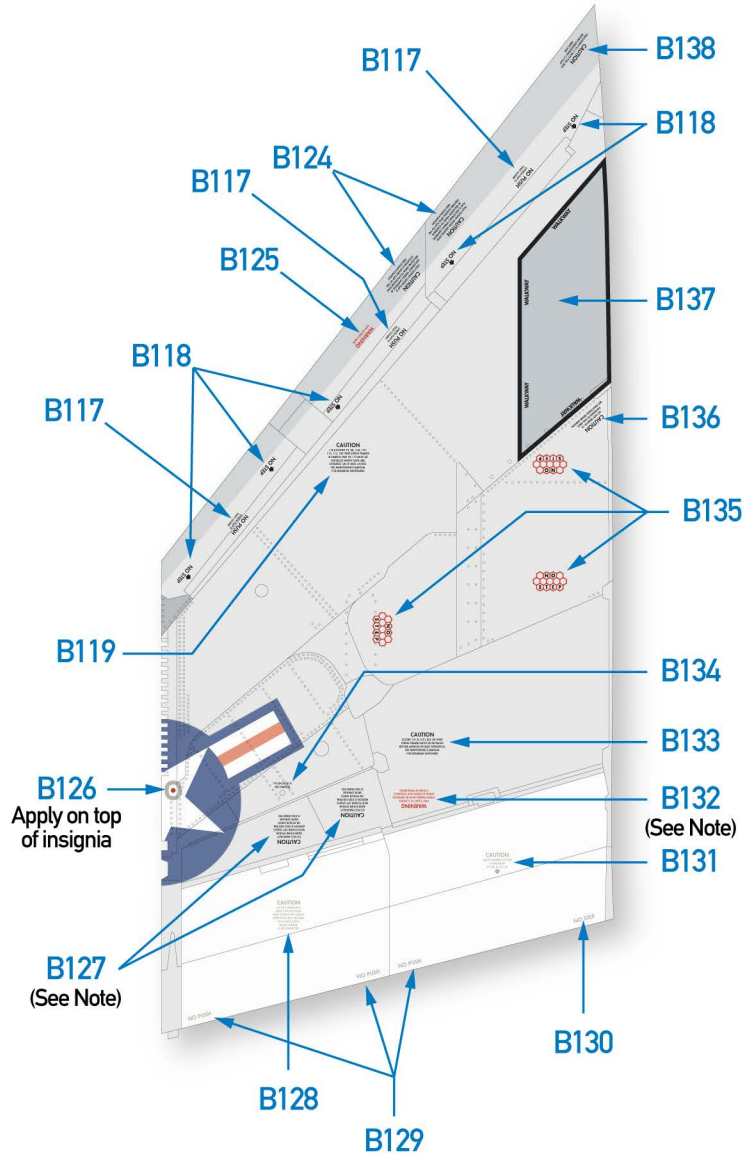
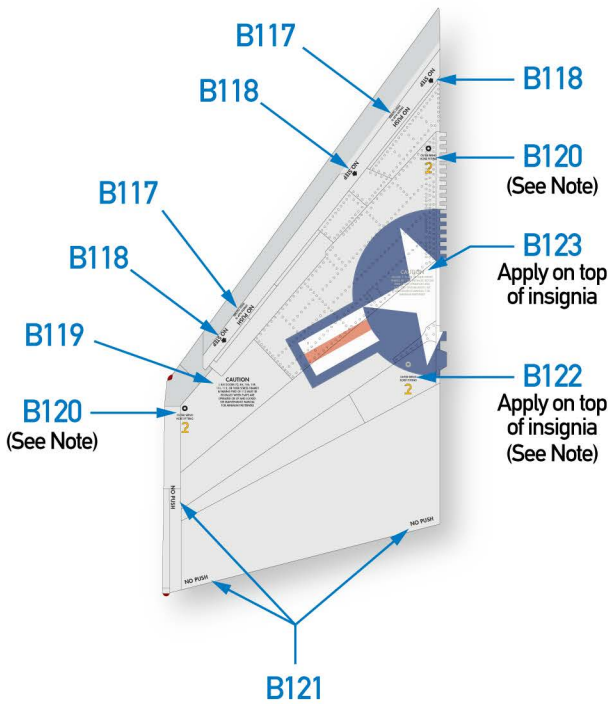

Note:

B127/B132: Note the orientation of these items. Tops of letters face the trailing edge of the wing.

B120/B122: The yellow hoisting hook symbol was not present on early F4H-1s and F-4Bs. It appeared sometime around 1965, but we have not been able to determine a precise production block or BuNo for its implementation. Trim the symbol off if you are building an early Phantom.

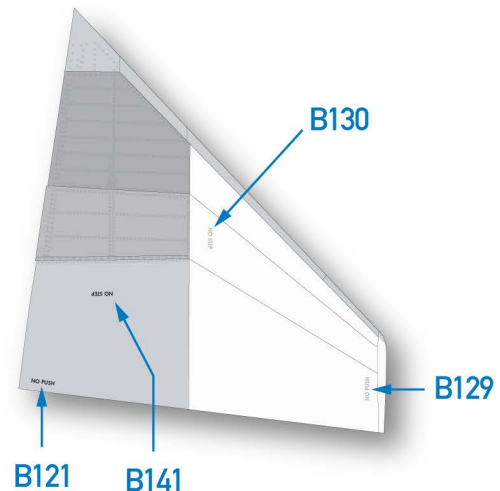
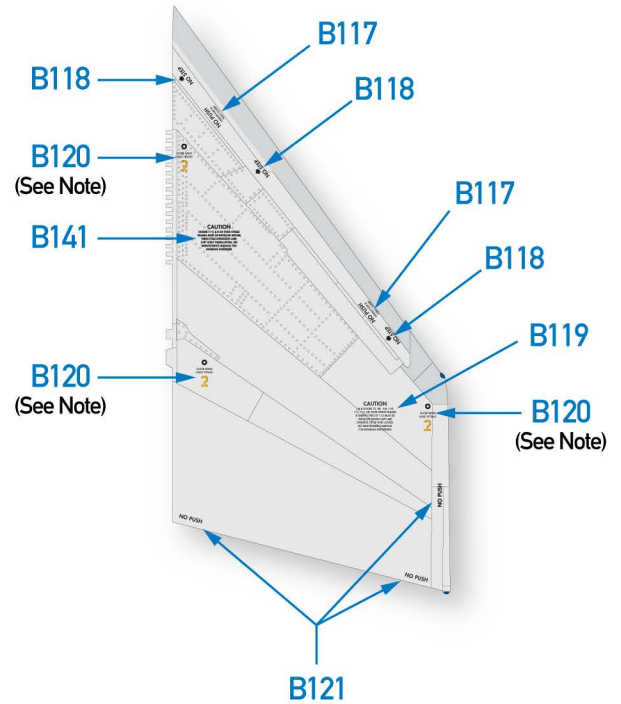
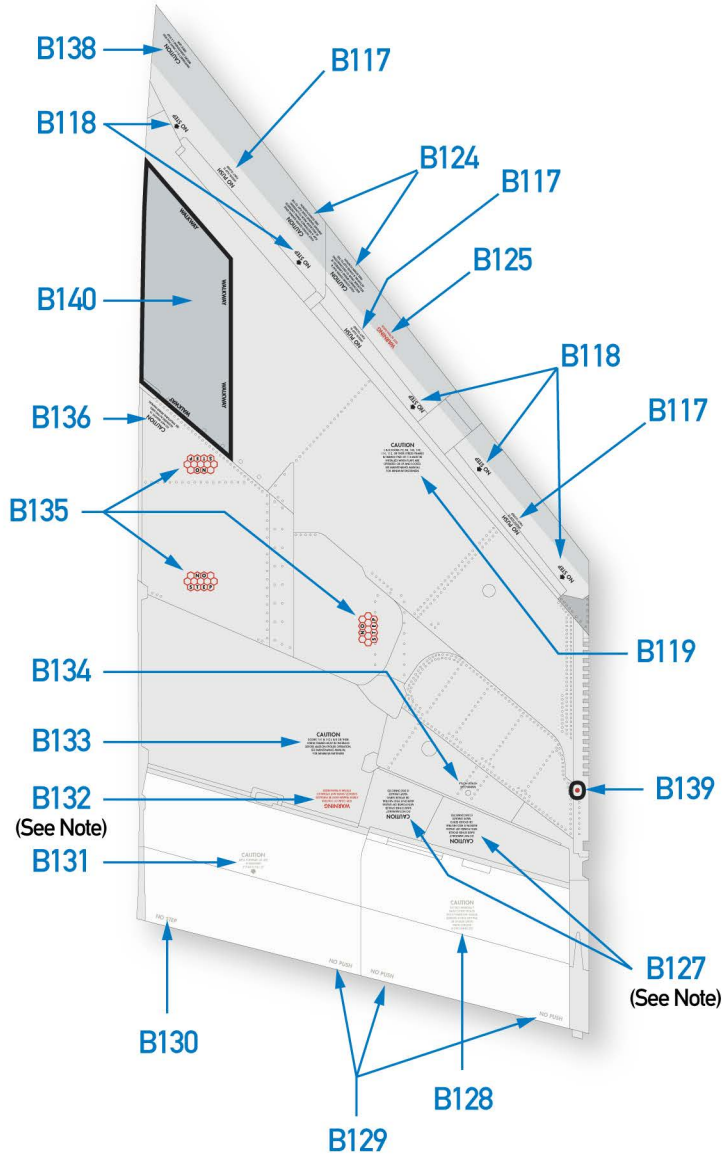

Note:

B127/B132: Note the orientation of these items. Tops of letters face the trailing edge of the wing.

B120: The yellow hoisting hook symbol was not present on early F4H-1s and F-4Bs. It appeared sometime around 1965, but we have not been able to determine a precise production block or BuNo for its implementation. Trim the symbol off if you are building an early Phantom.

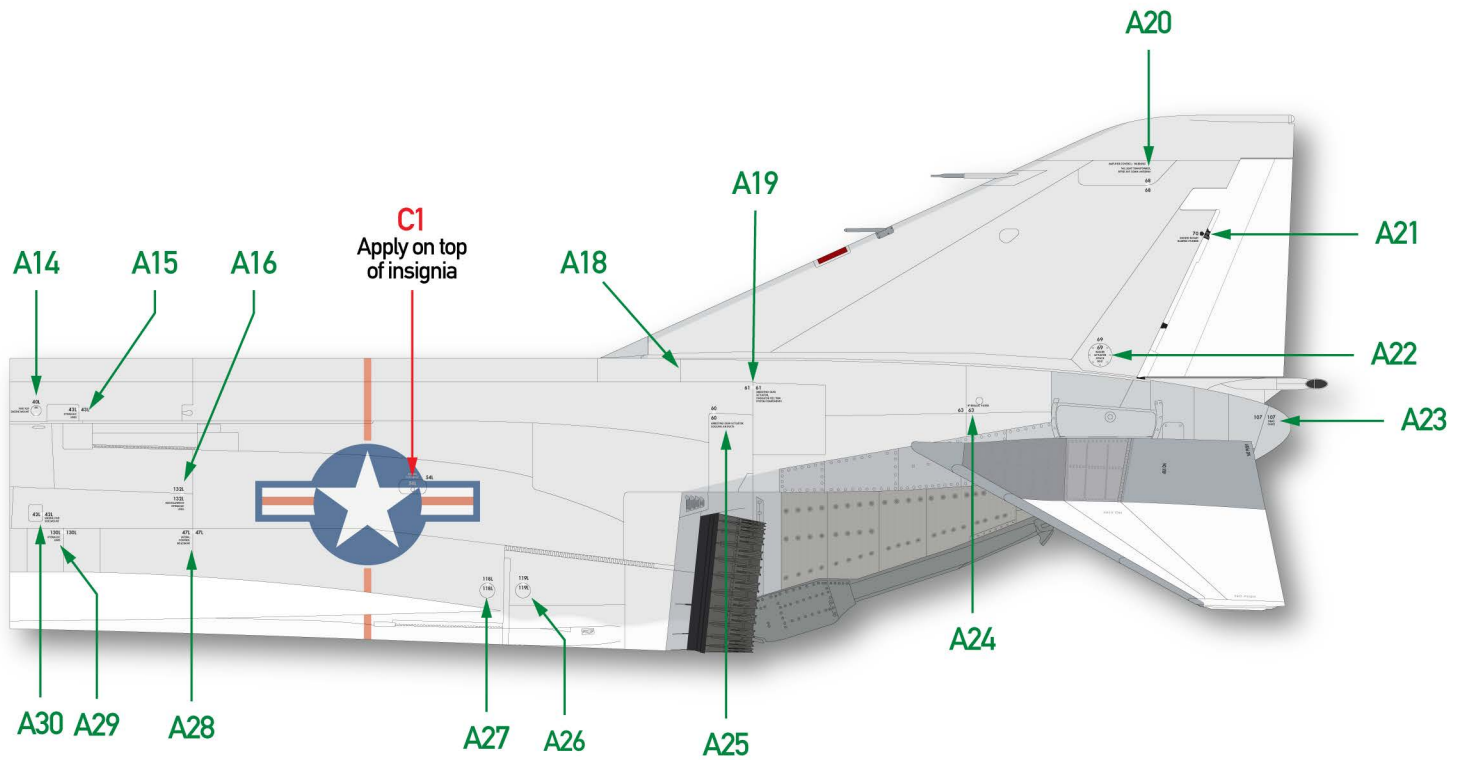
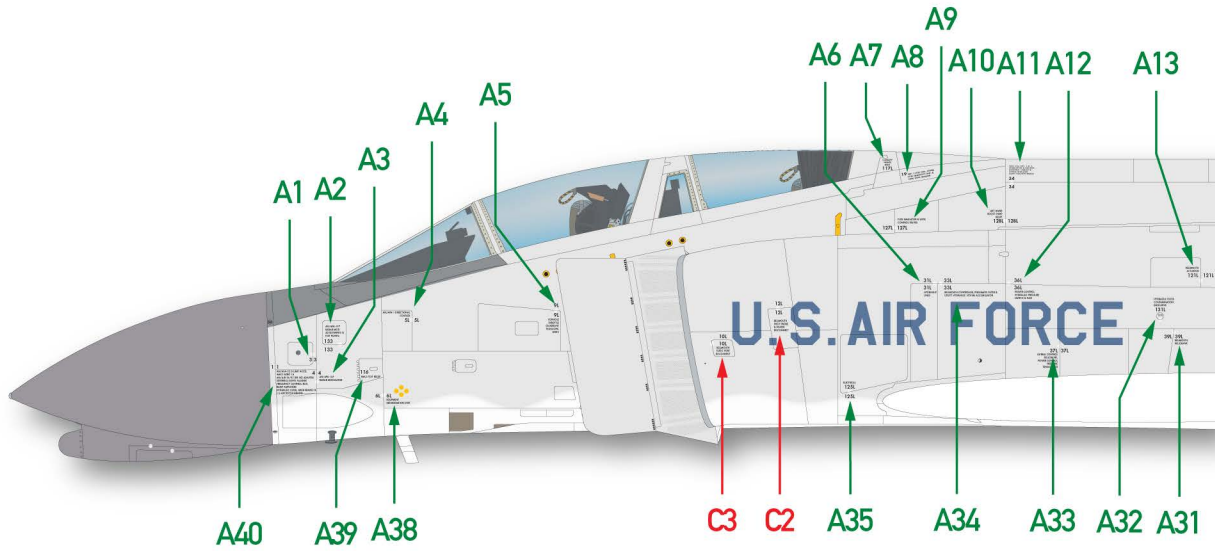

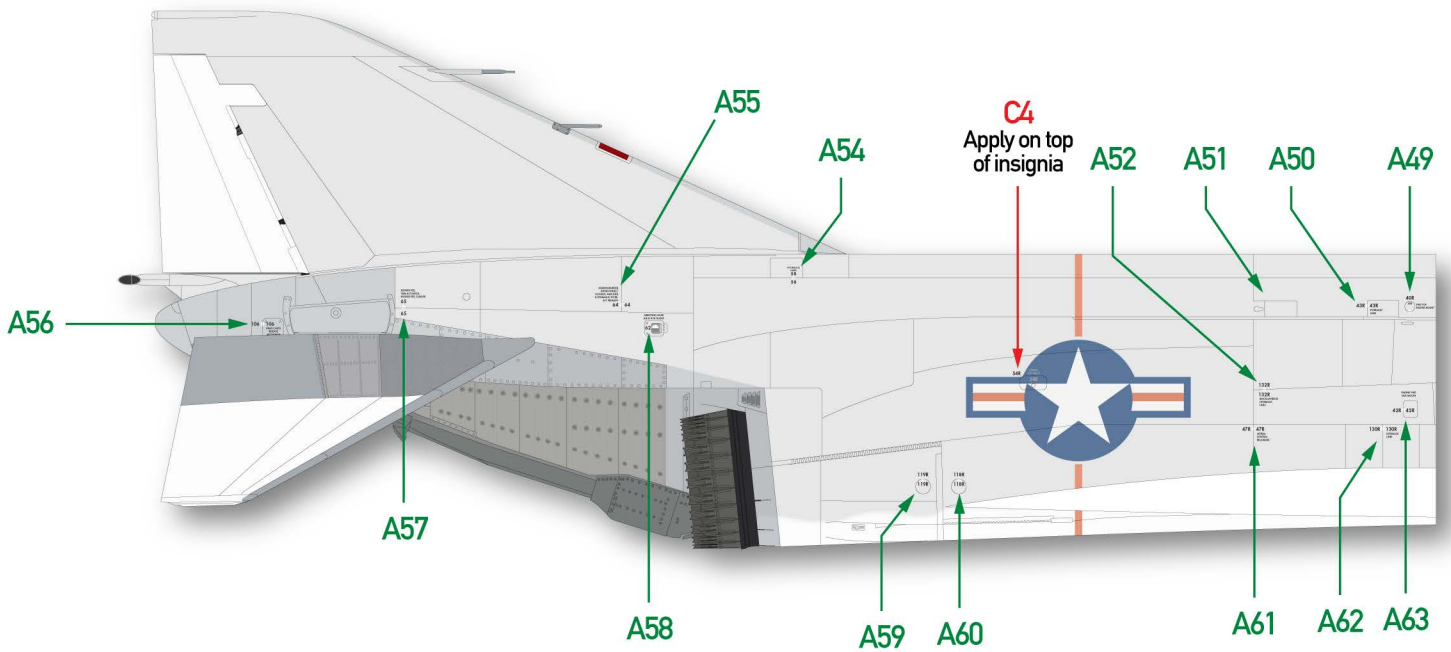
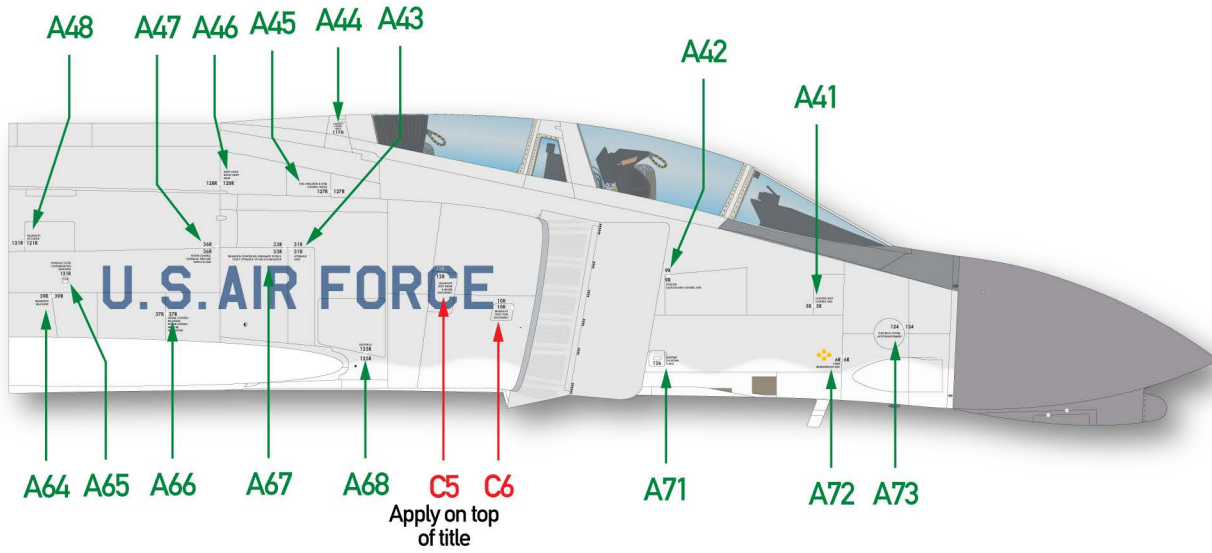

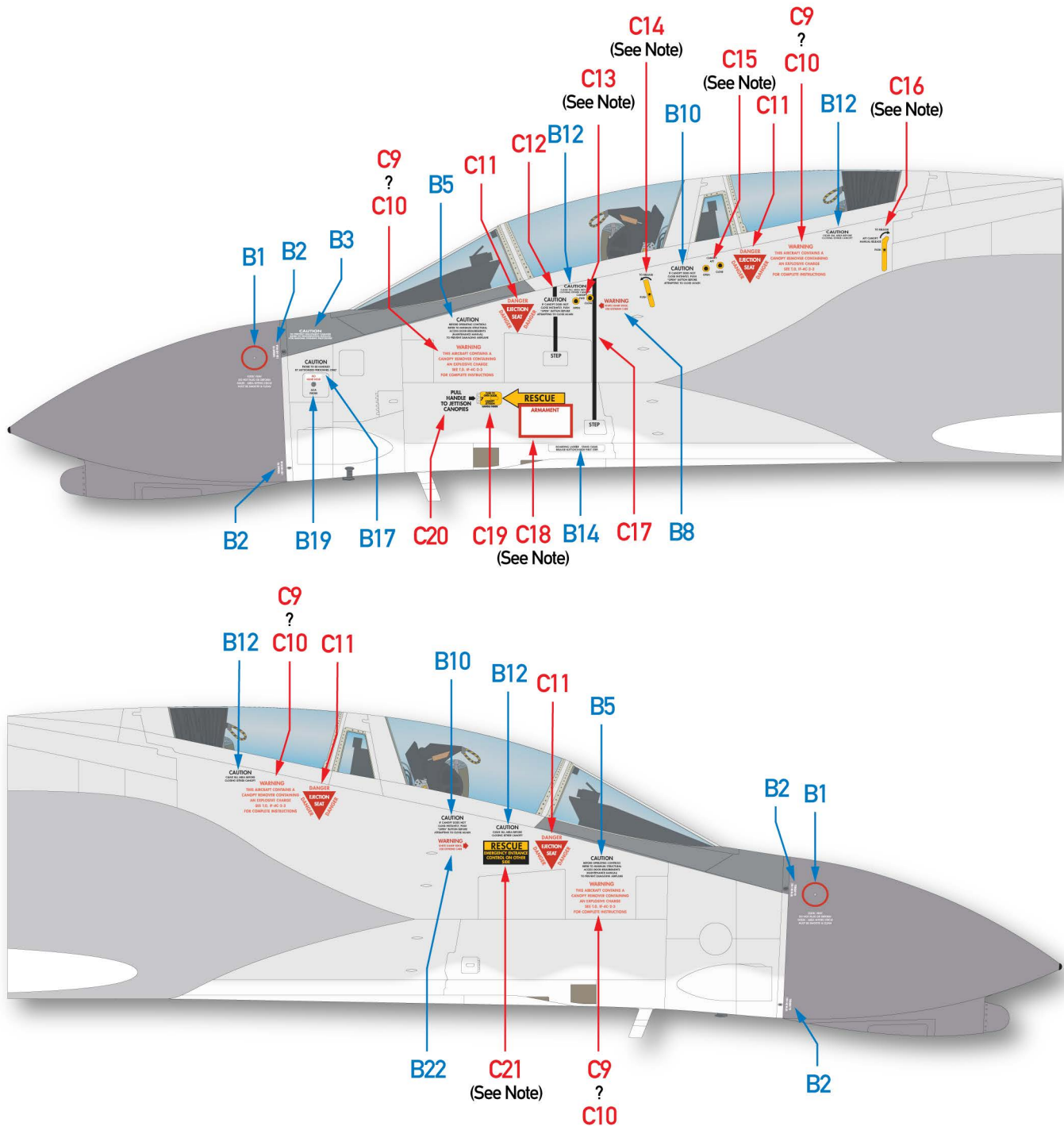

Notes:

C9/C10: The salmon colored stencil (C9) was most commonly used, but the bright red version (C10) was also applied on some aircraft.

C13 - C16: Canopy open/close buttons & handles are provided to fit the ZM and Tamiya kit scribing (as closely as can make them), as well as in the actual scale size and shape based on tracings and measurements of these items on an actual F-4. The kit scribing (on every existing 1/48 F-4 kit we have found) is not really accurate in size or shape. We recommend filling the scribed detail and using the "B" versions of these decals, which are accurate scale representations of the real thing.

C18: The red and white armament placard was not originally applied on early Light Gull Gray/white F-4Cs. We believe the decal may have been supplied with the aircraft, but not applied at the factory. This is the most common location, but others were seen as well.

C21: Two variations are provided. The one shown in the drawing is by far the most common.

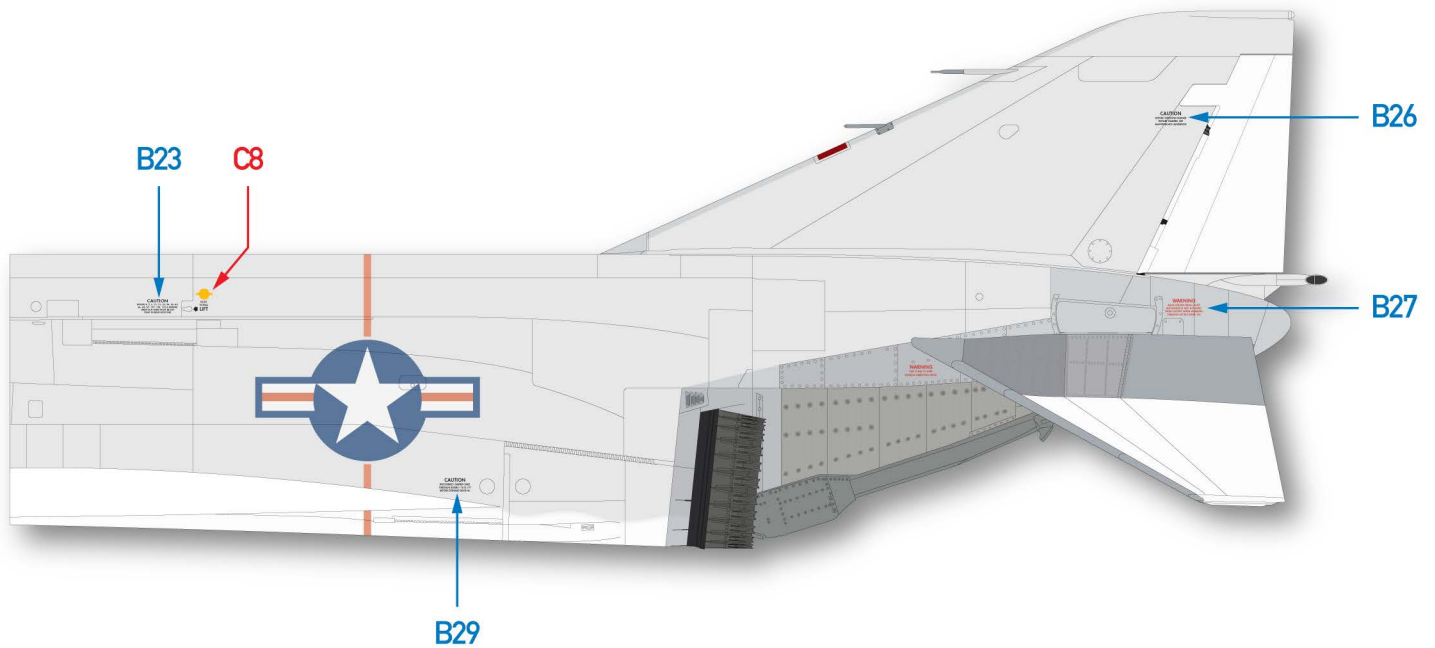
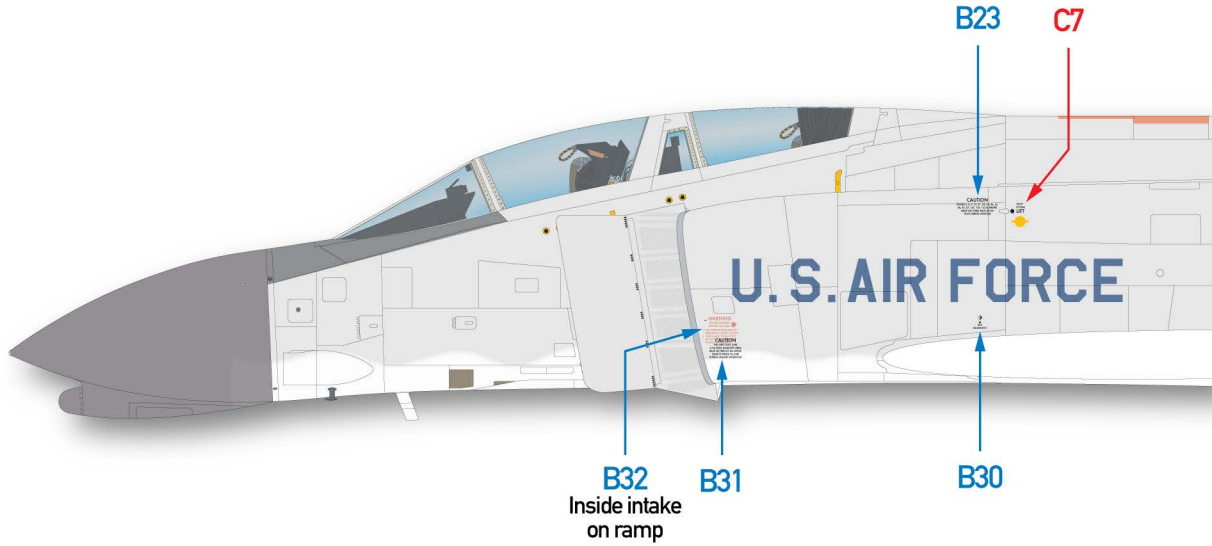

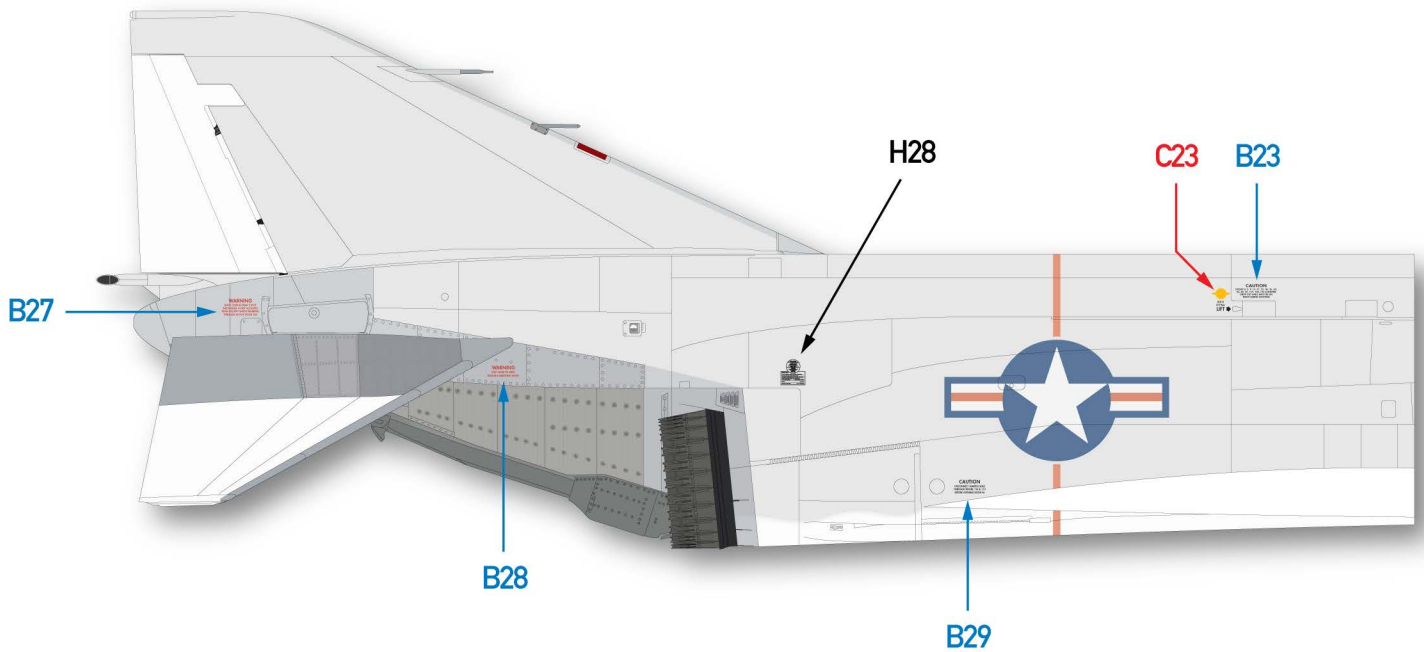
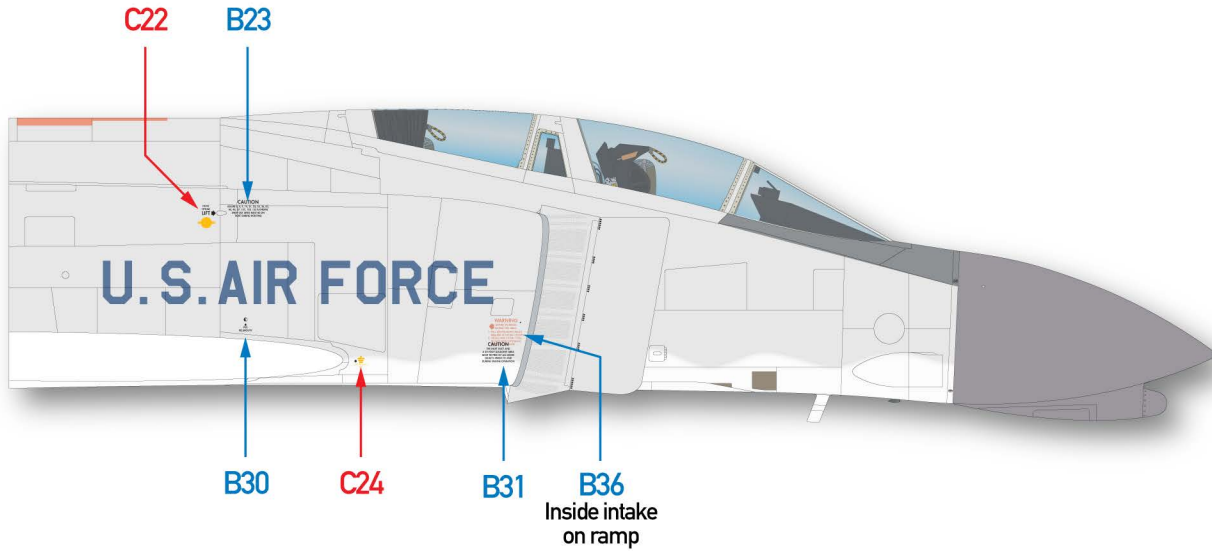

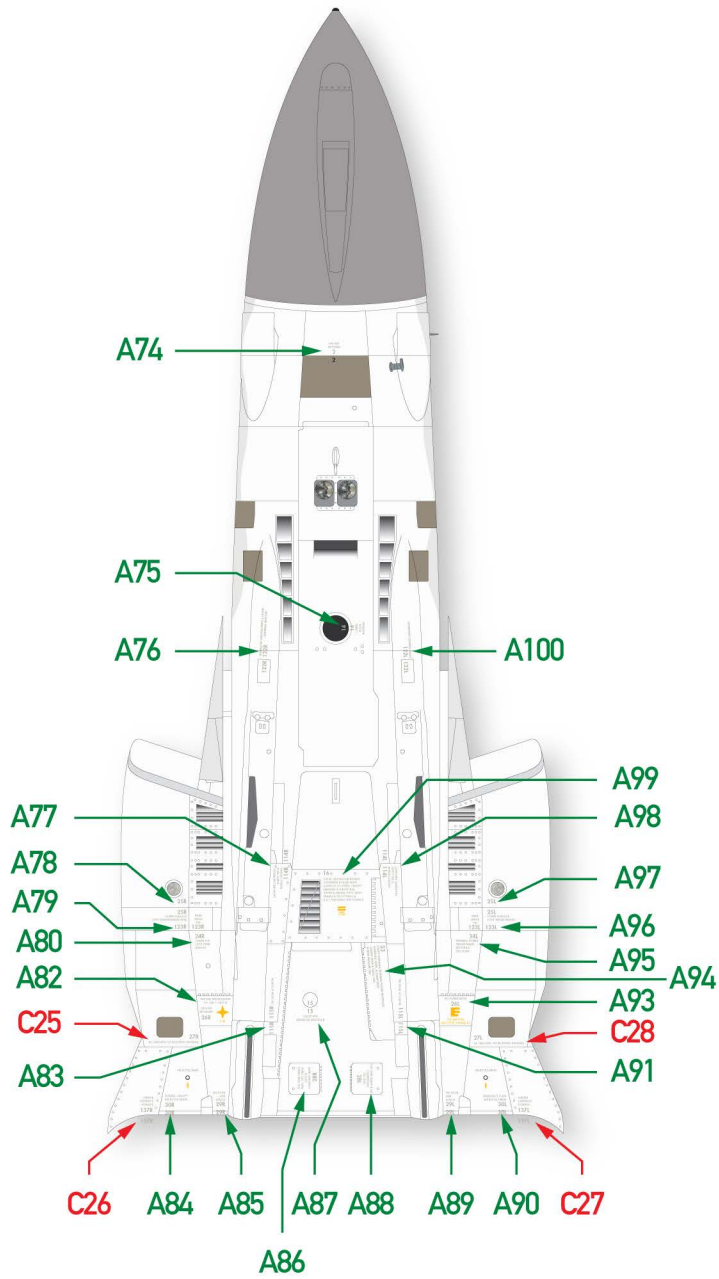

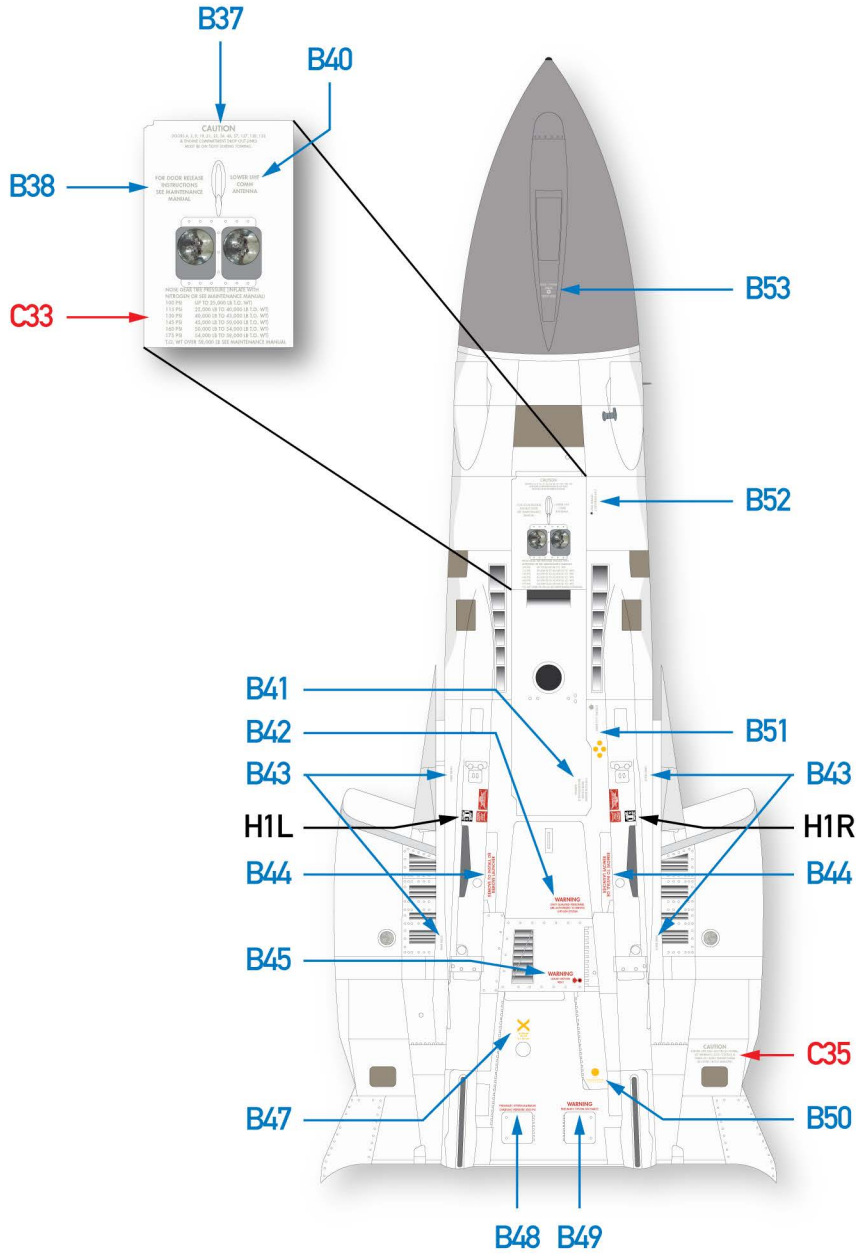

Note: Decal C34 omitted intentionally

↑
Forward

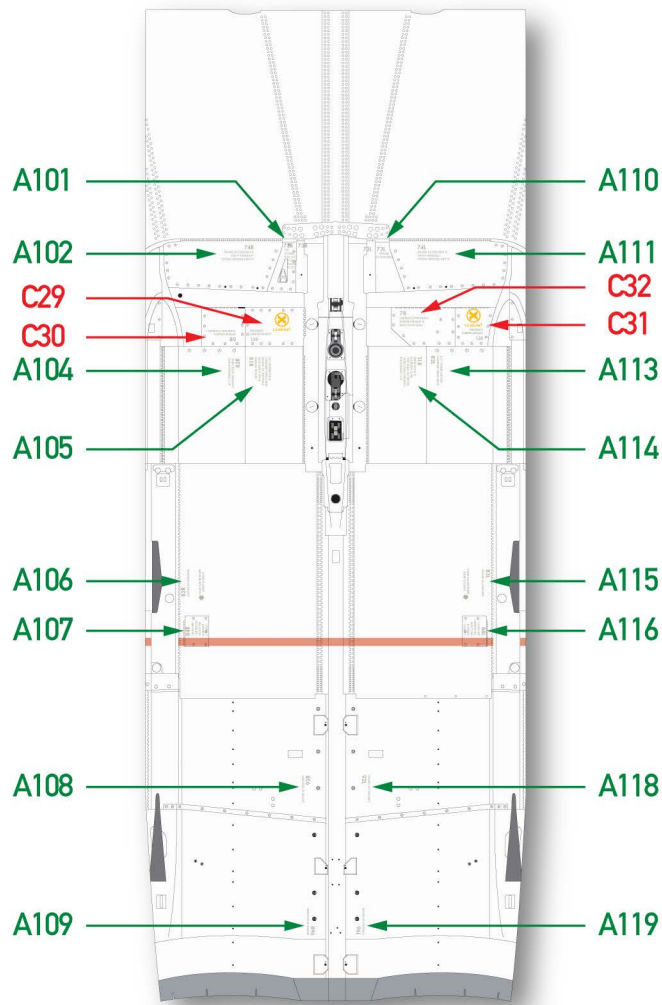

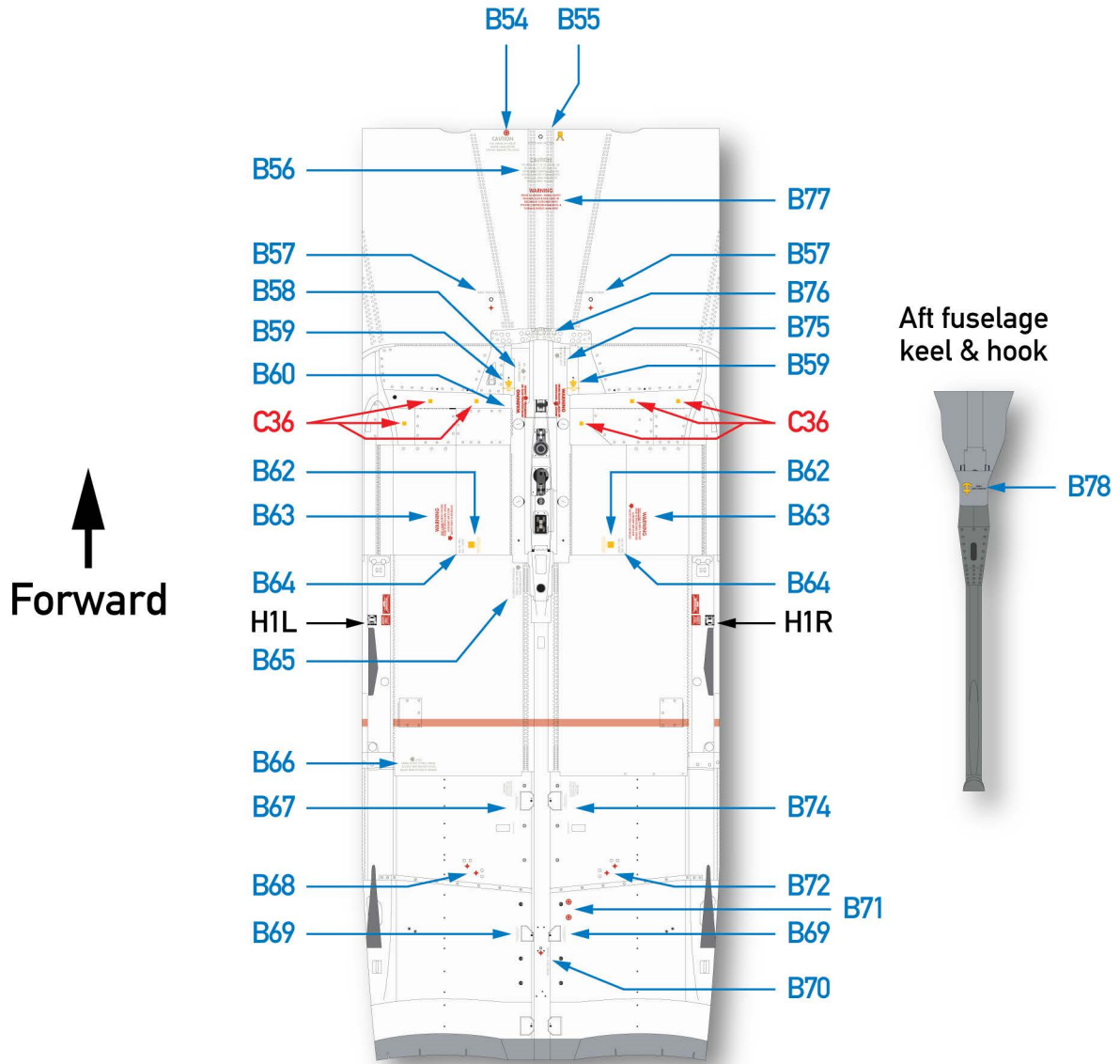

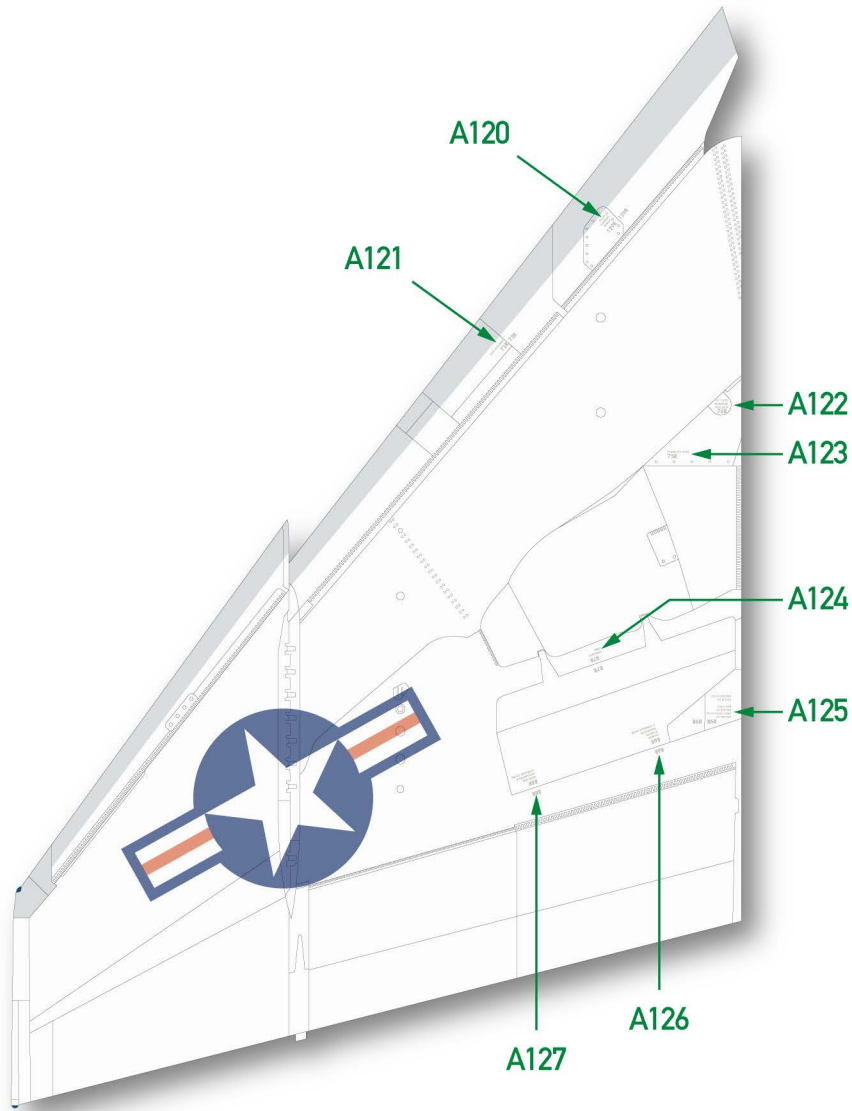

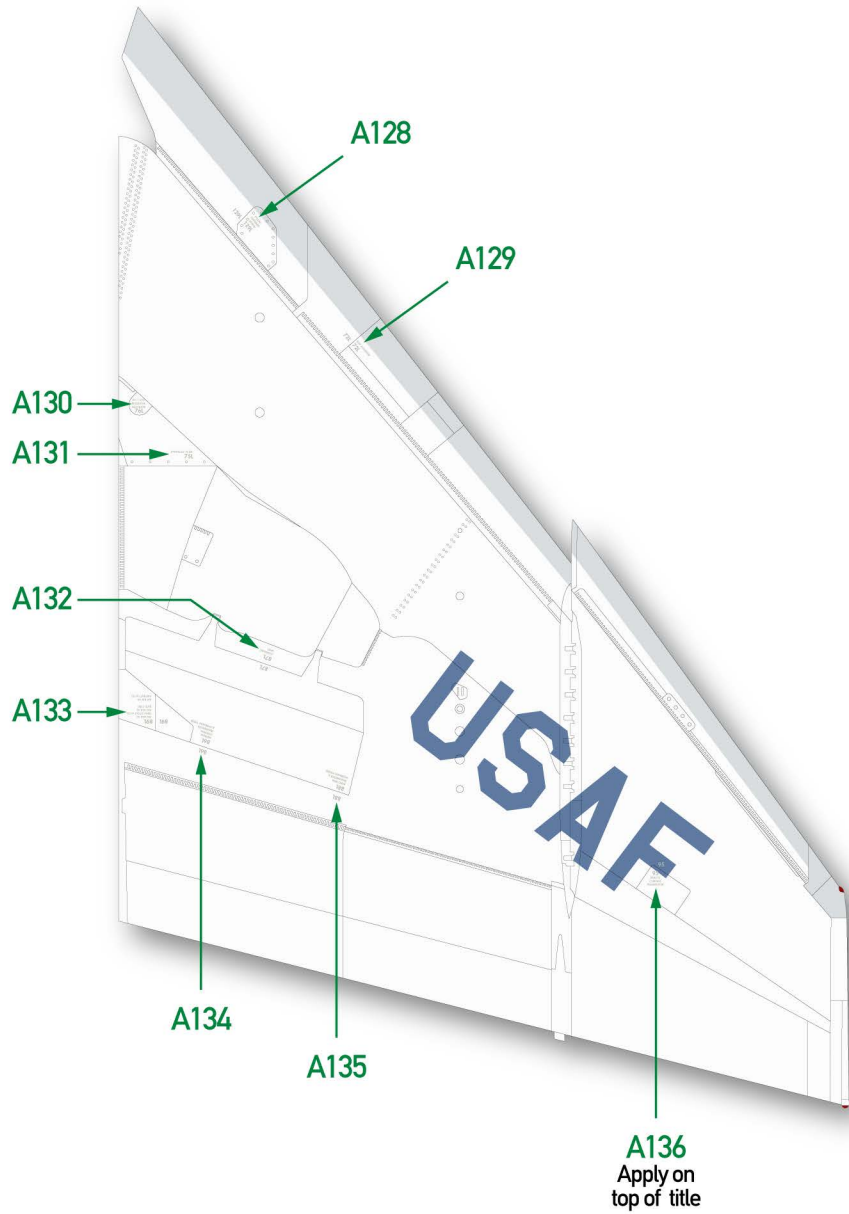

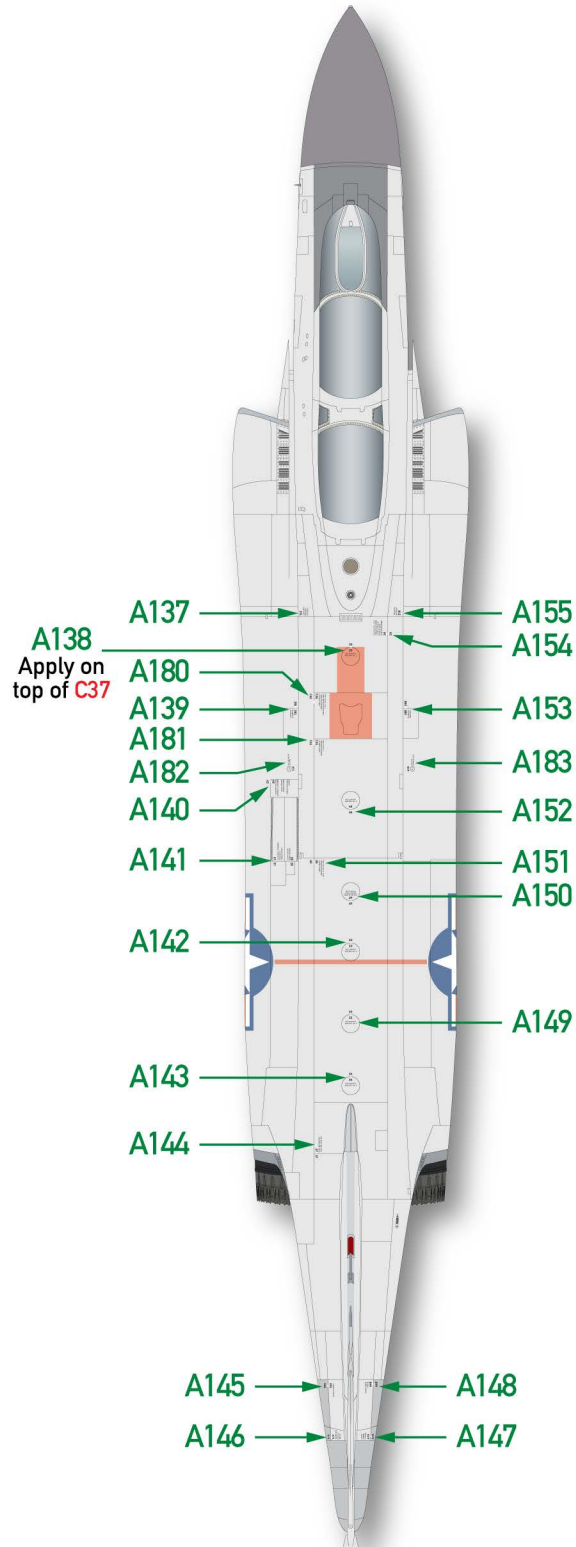

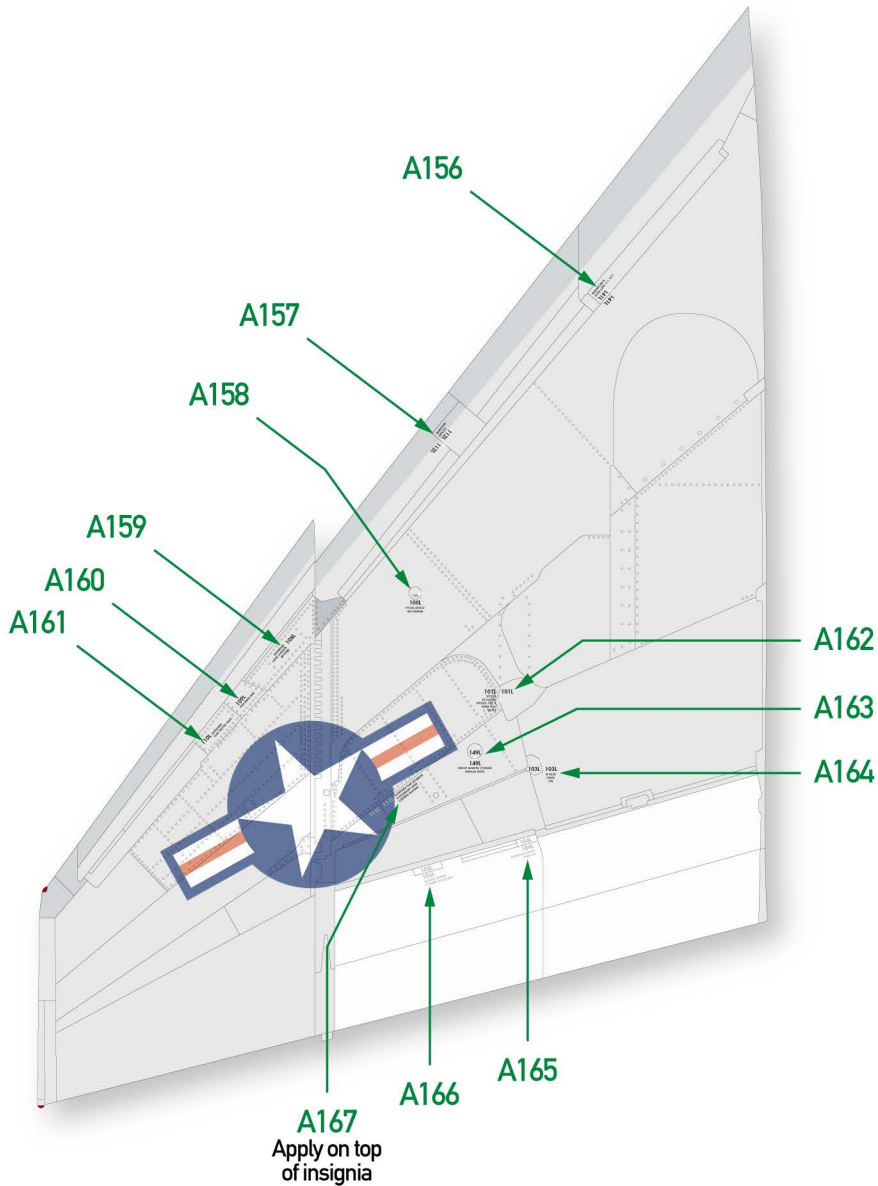

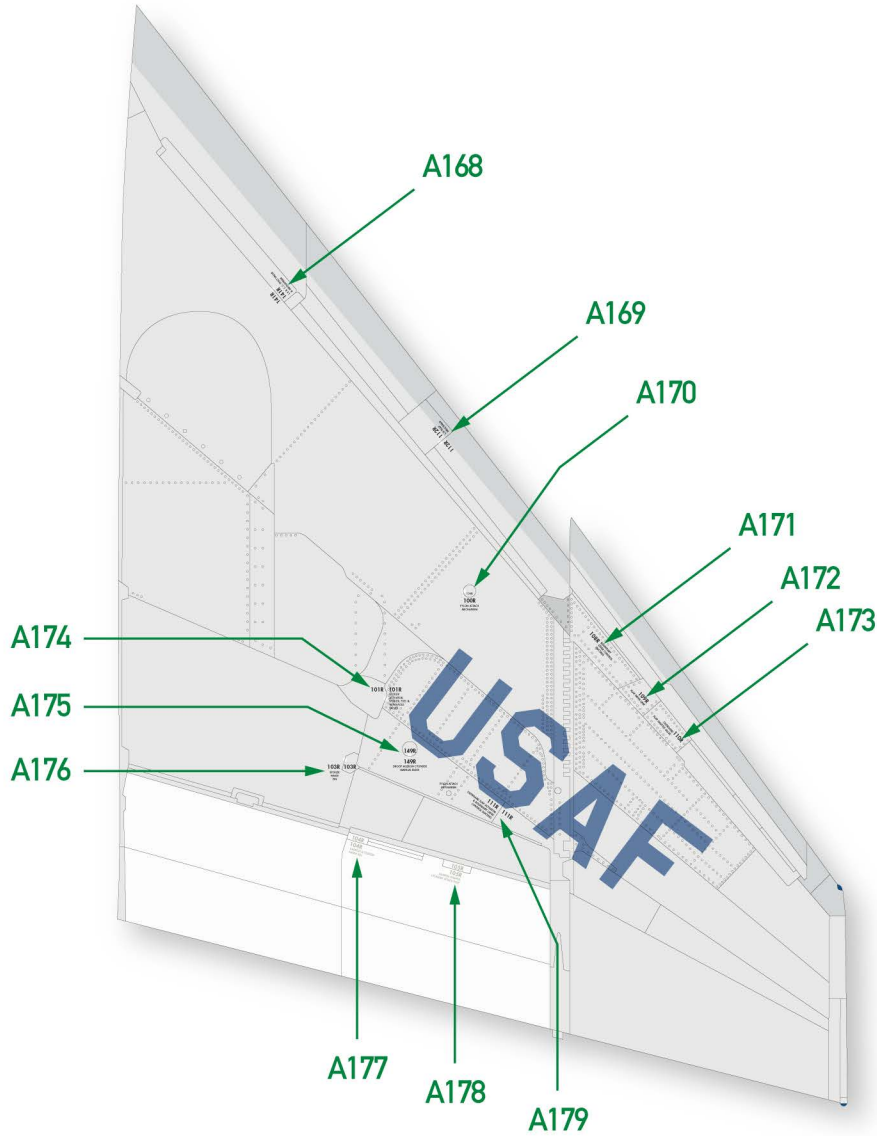

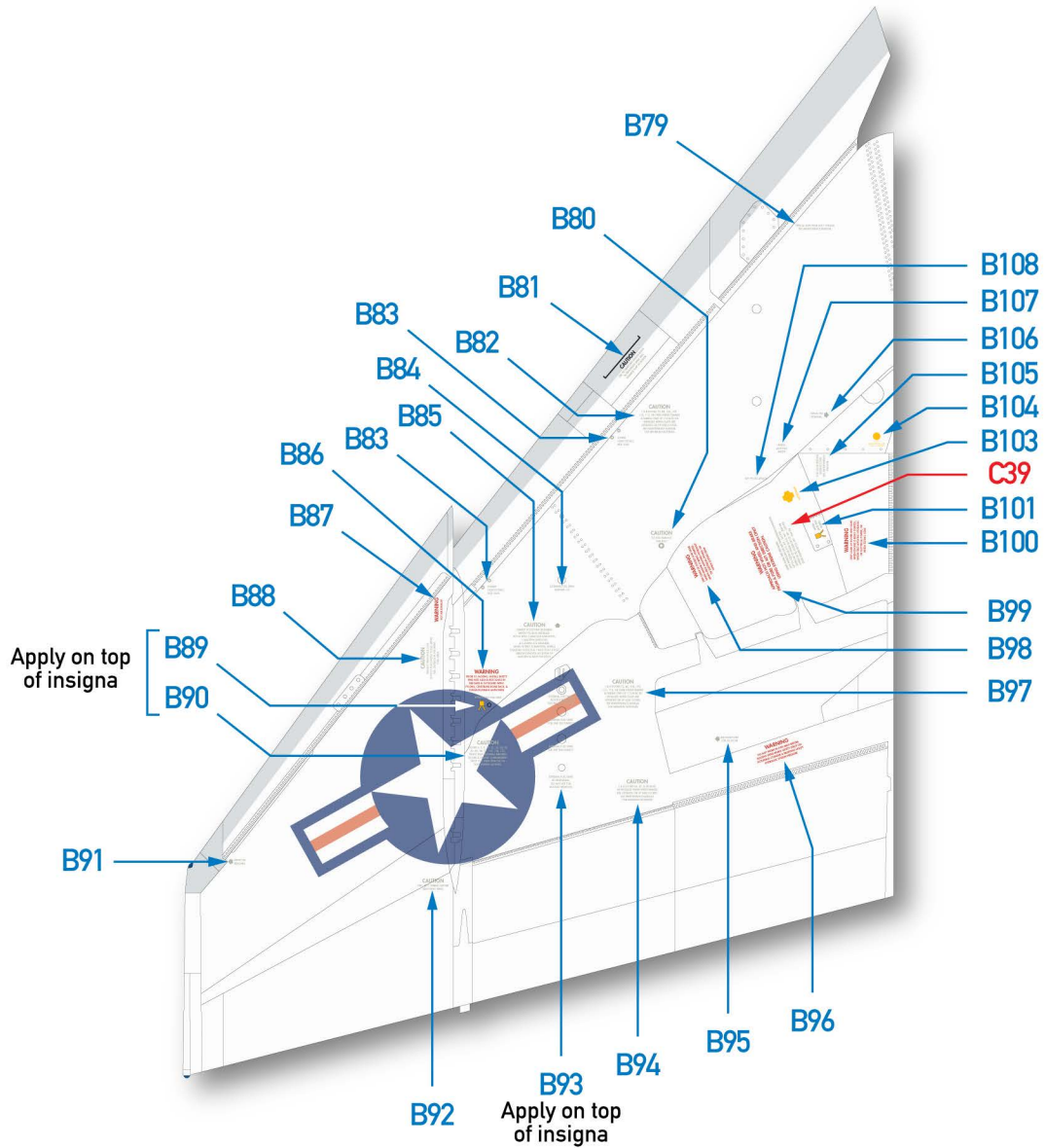

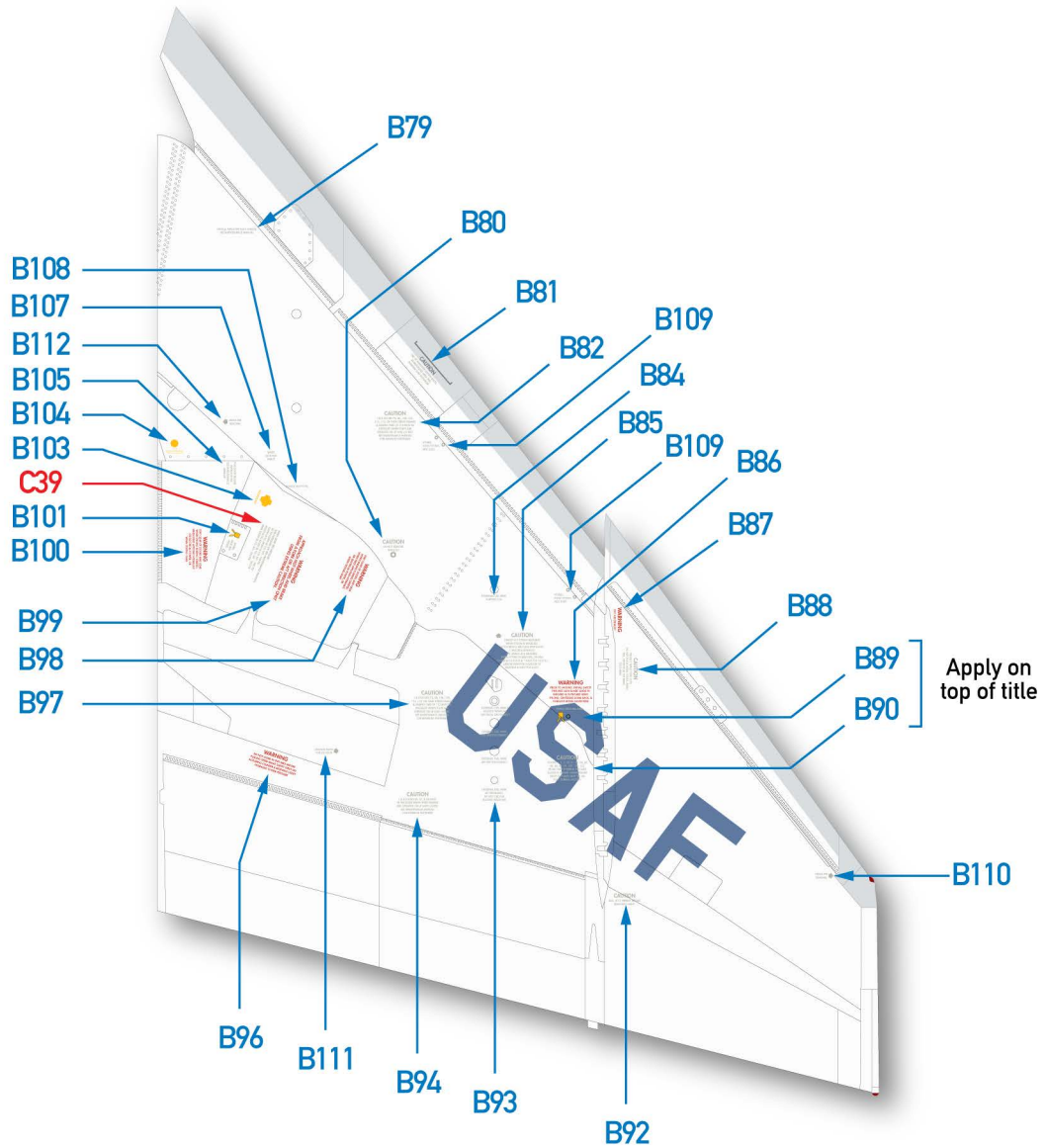

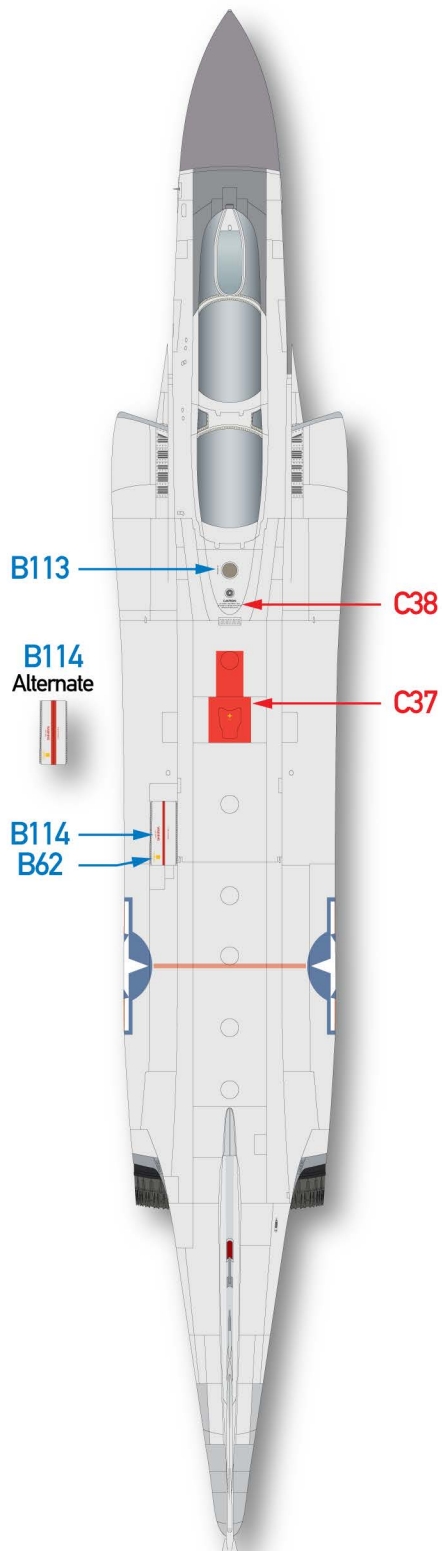

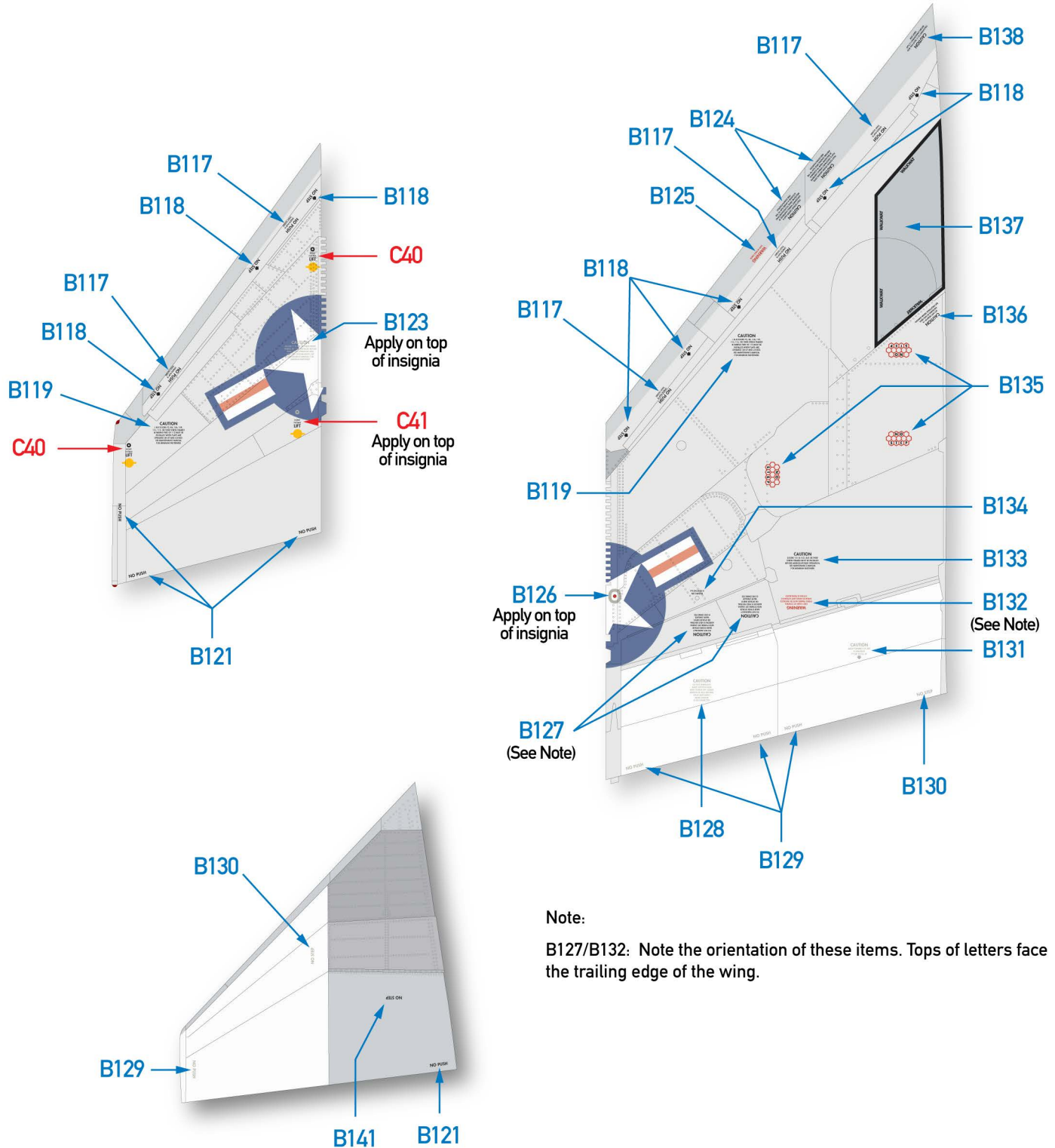

Note:

B127/B132: Note the orientation of these items. Tops of letters face the trailing edge of the wing.

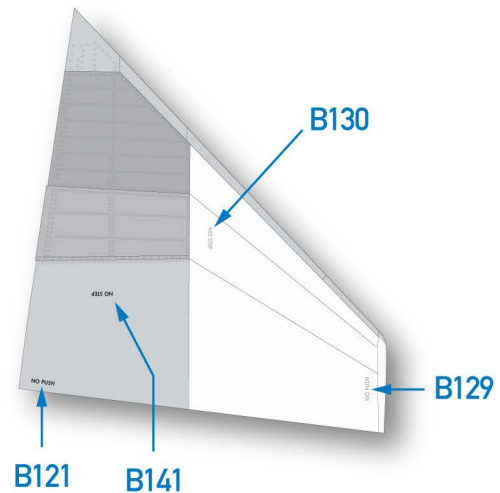
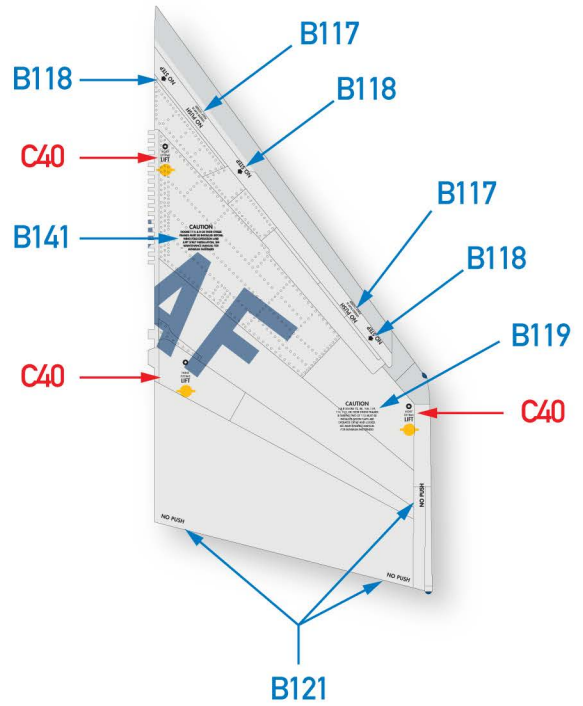
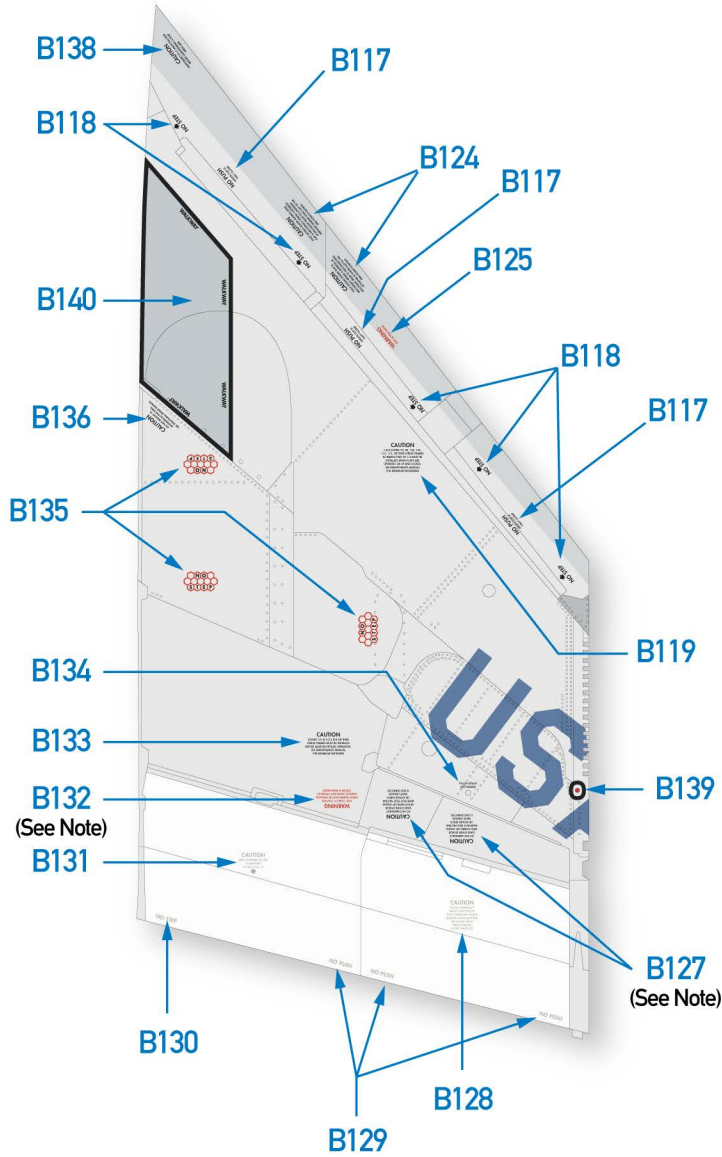

Note:

B127/B132: Note the orientation of these items. Tops of letters face the trailing edge of the wing.

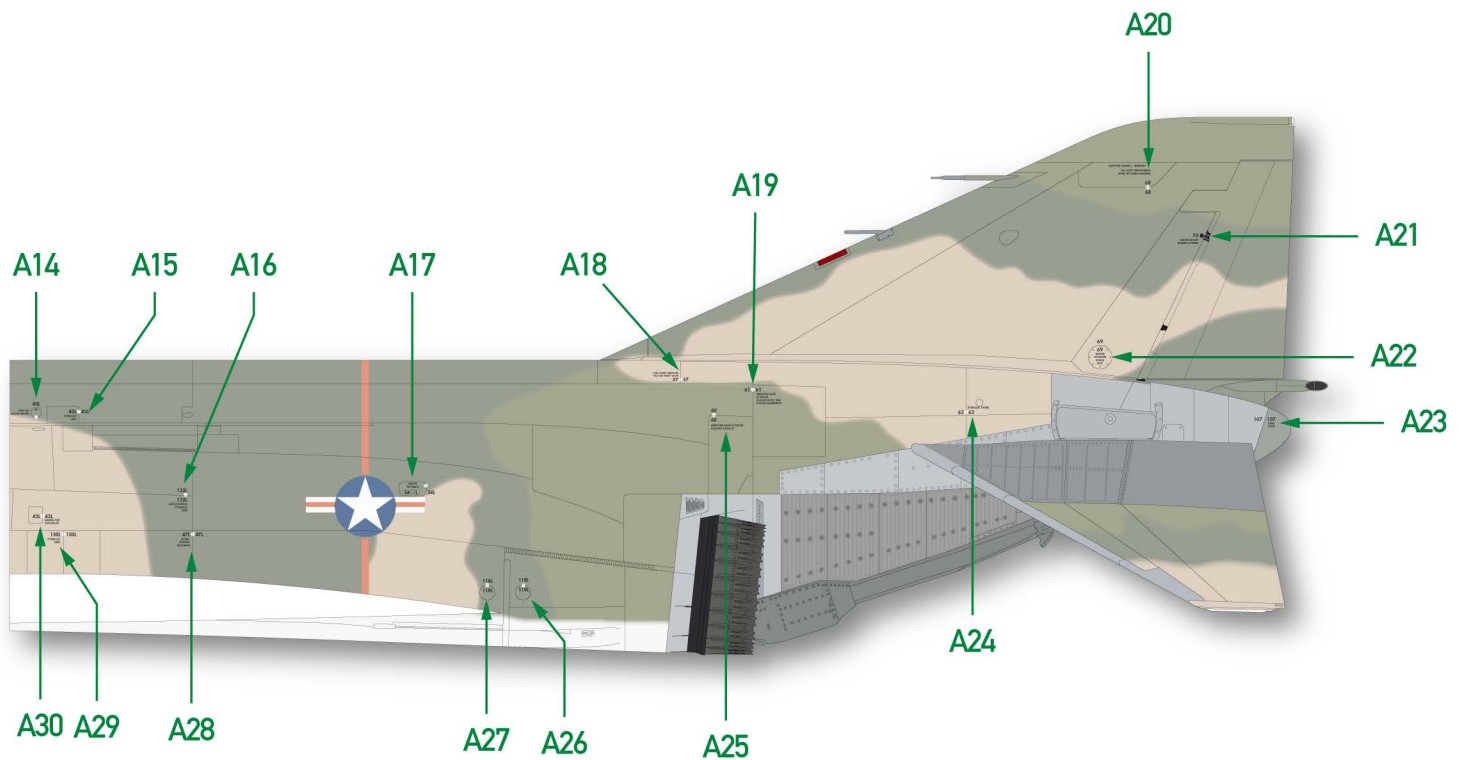
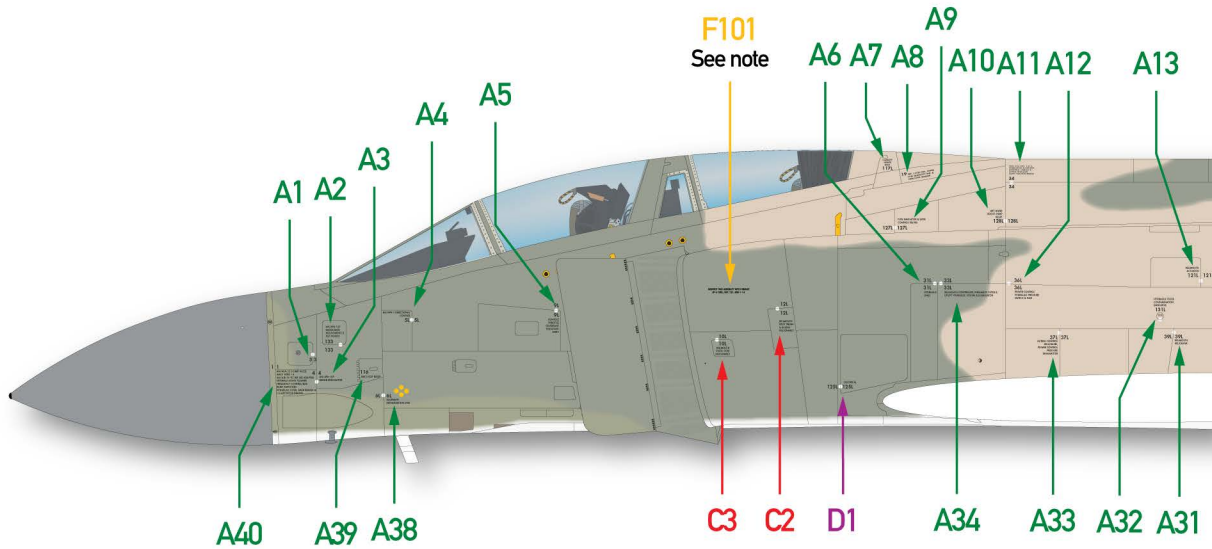

Note:

F101: This portion of the standard aircraft data block was applied on export aircraft (Iranian F-4Ds in this case). On USAF aircraft, there were two lines above it giving the production block number and USAF serial. Stencils applied to the Asia Minor camouflaged F-4Ds for Iran were identical to US F-4Ds.

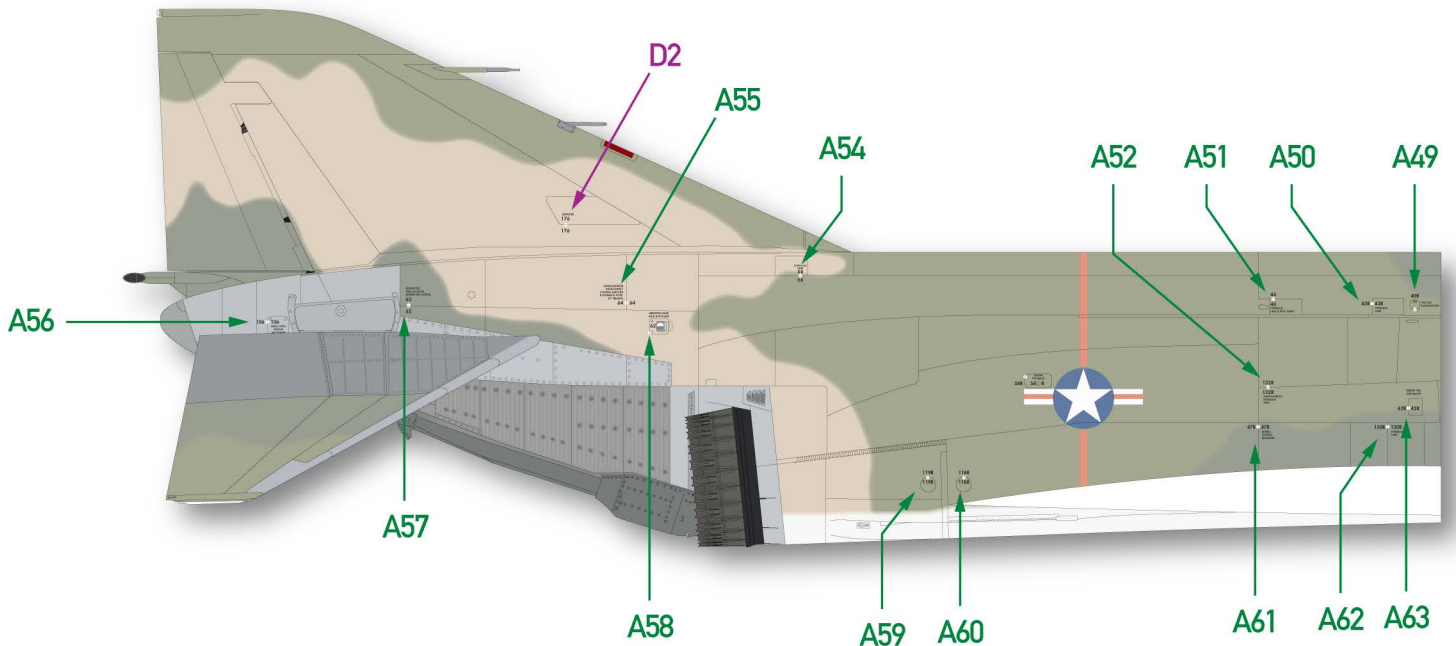
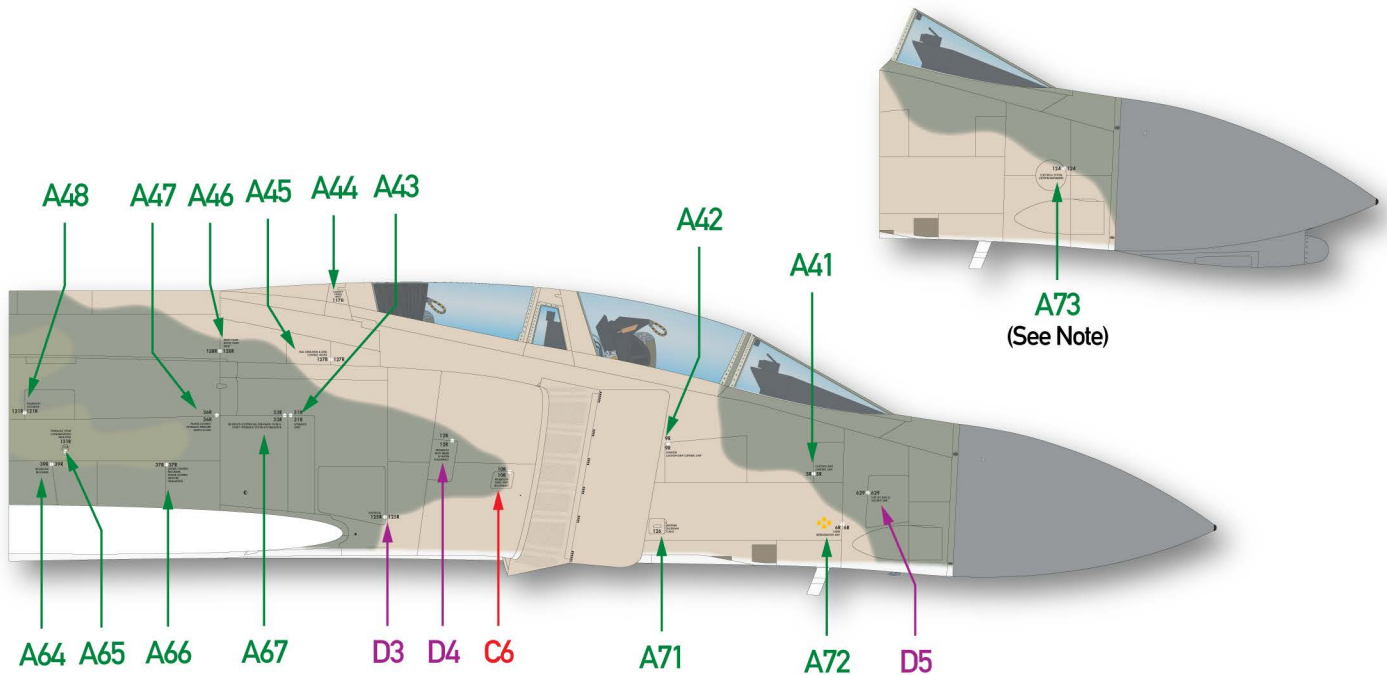

Note: The round Access Door 129 (decal A73) was seen on all F-4Cs and some early F-4Ds. When the KY-28 secure voice encryption system was installed, the trapezoidal Access Door 629 (decal D5) was installed. Earlier aircraft were updated throughout the late 1960s, but it was not seen fleet wide until well into the early 1970s.

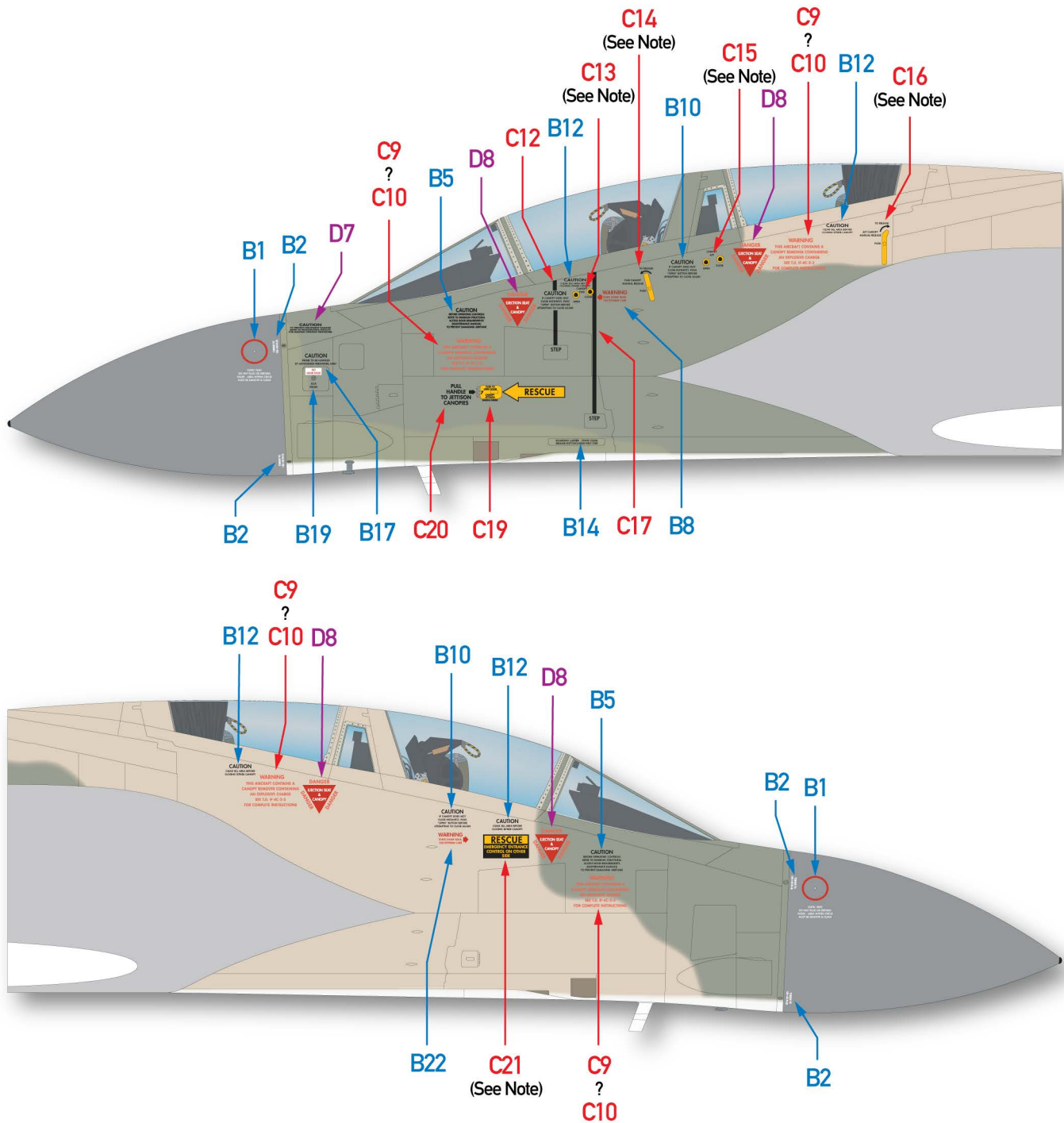

Notes:

C9/C10: The salmon colored stencil (C9) was most commonly used, but the bright red version (C10) was also applied on some aircraft.

C13 - C16: Canopy open/close buttons & handles are provided to fit the ZM and Tamiya kit scribing (as closely as can make them), as well as in the actual scale size and shape based on tracings and measurements of these items on an actual F-4. The kit scribing (on every existing 1/48 F-4 kit we have found) is not really accurate in size or shape. We recommend filling the scribed detail and using the "B" versions of these decals, which are accurate scale representations of the real thing.

C21: Two variations are provided. The one shown in the drawing is by far the most common.

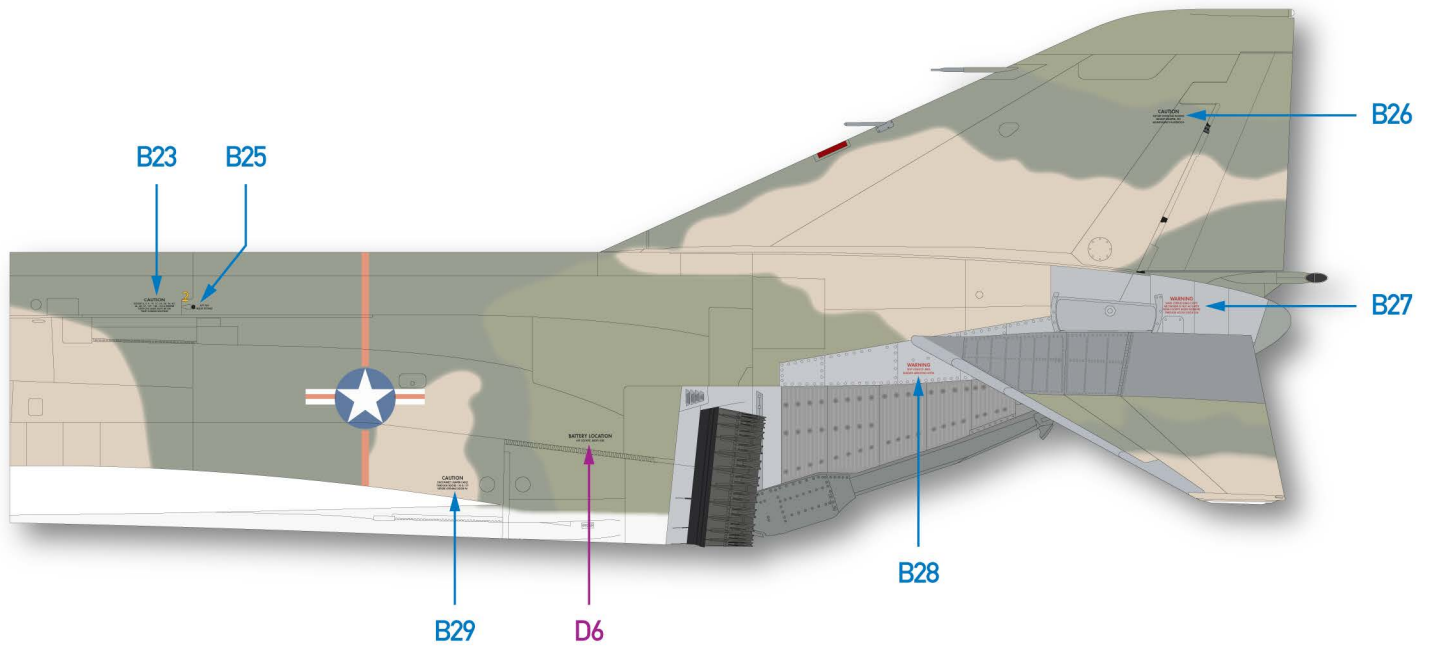
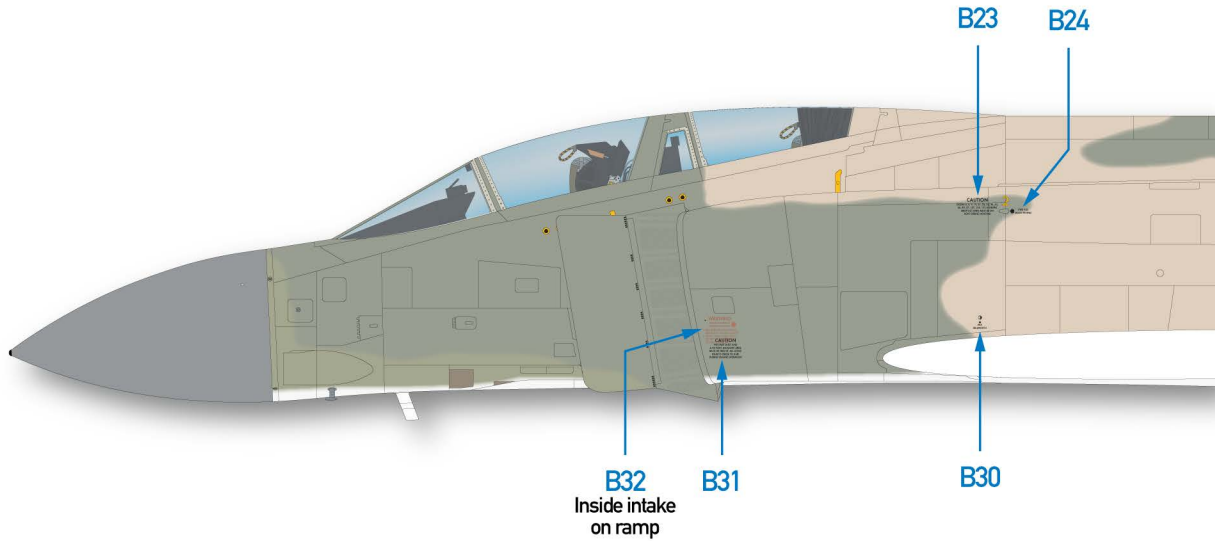

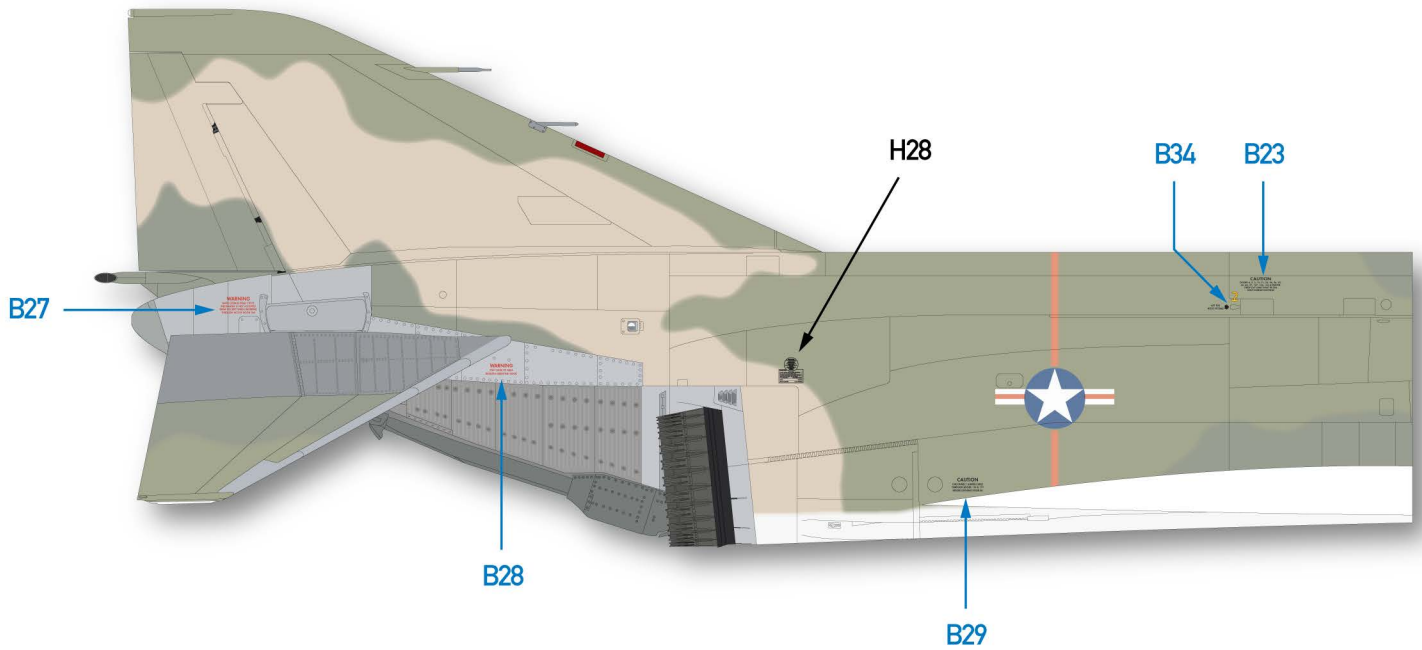
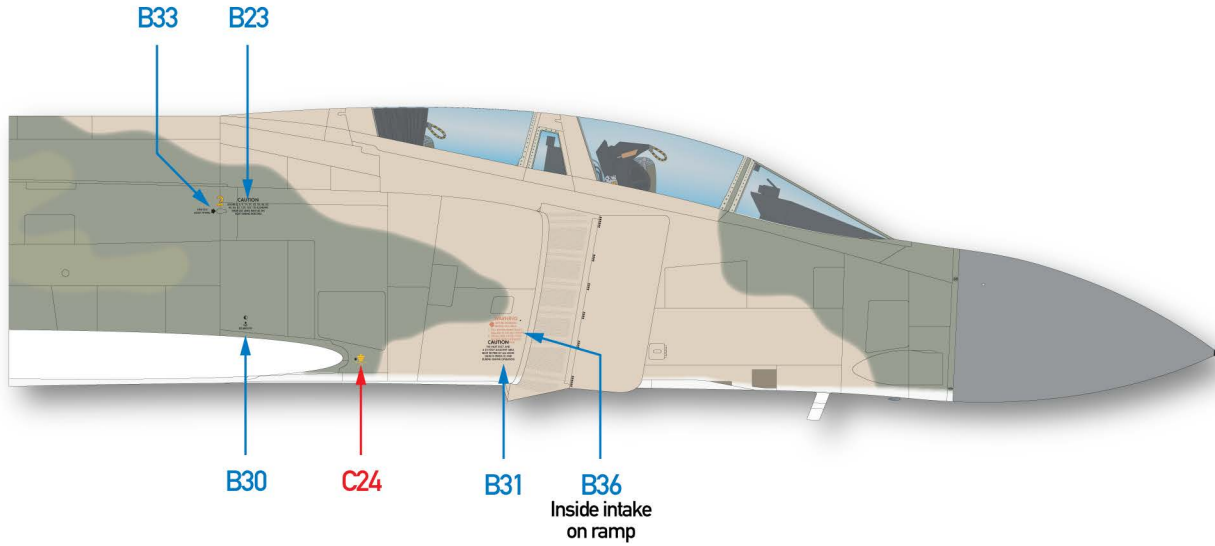

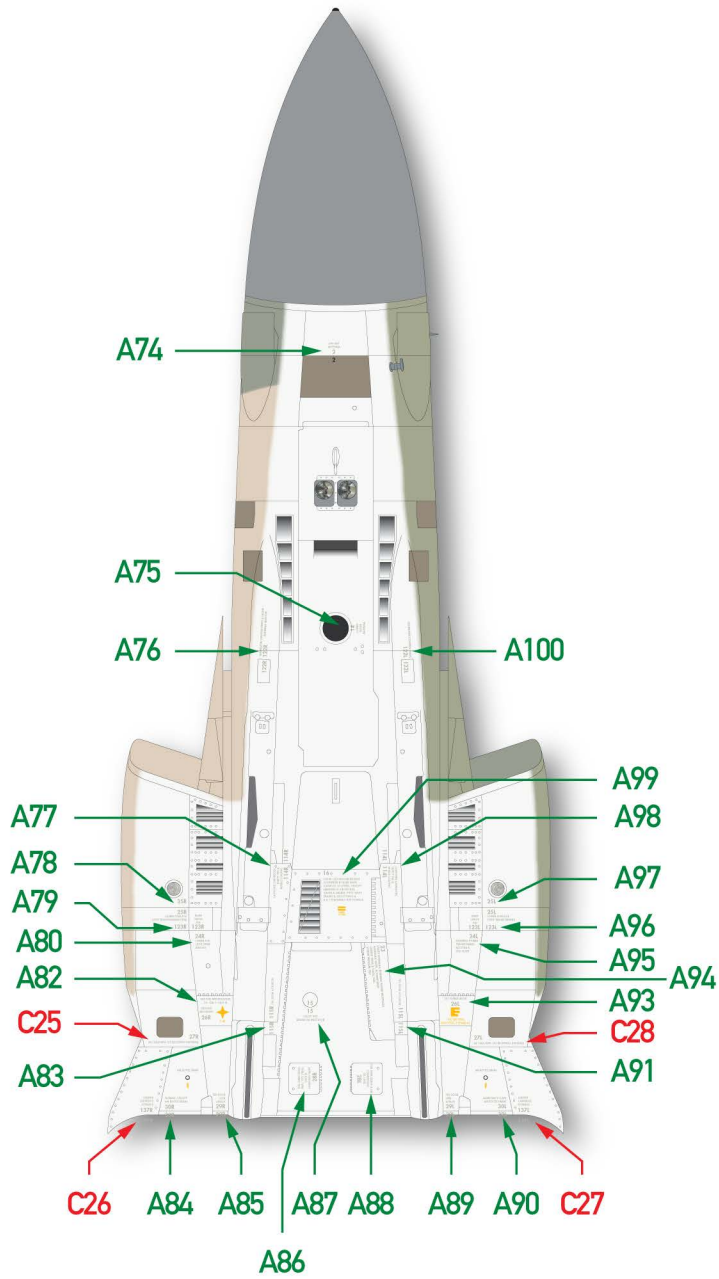

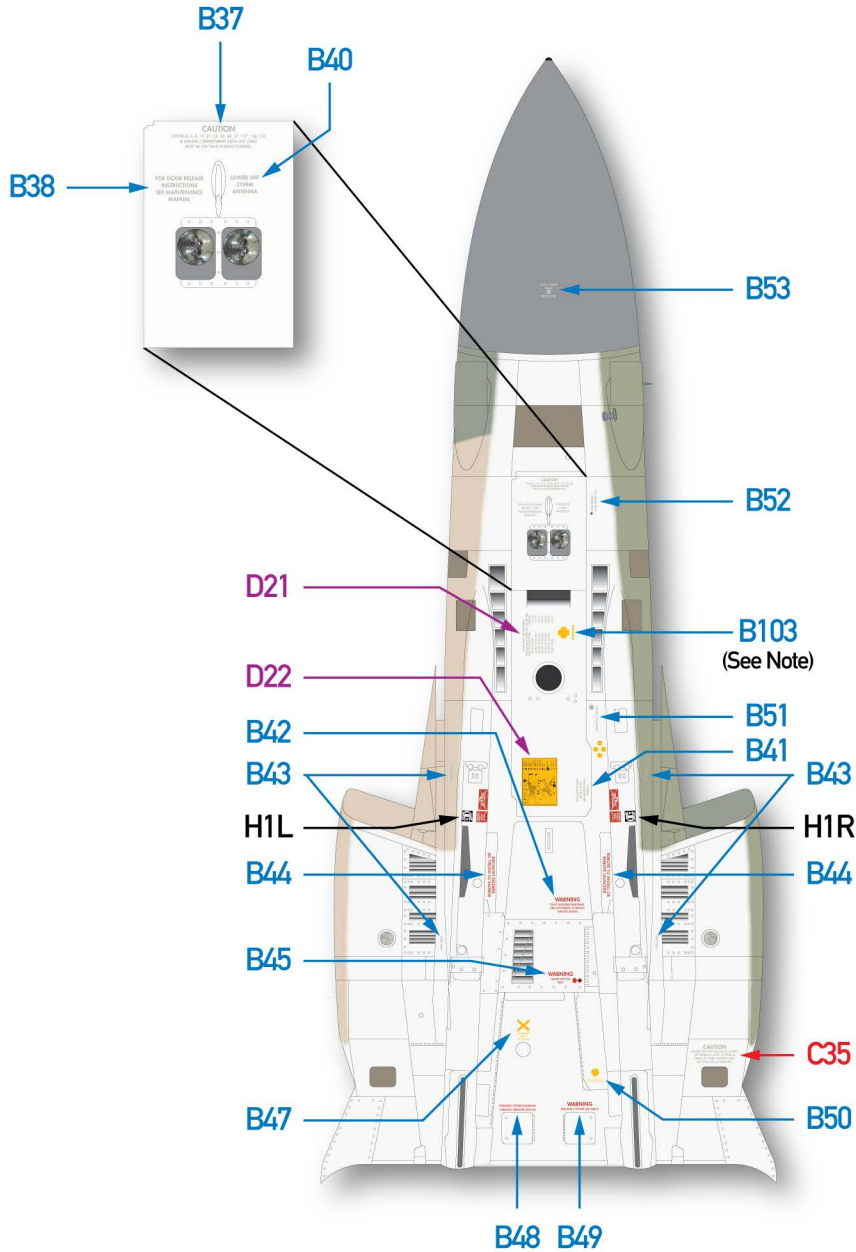

Notes:

Decal C34 omitted intentionally.

B103: Not applied until well into F-4D production. We do not have a specific block or serial, so check references.

↑
Forward

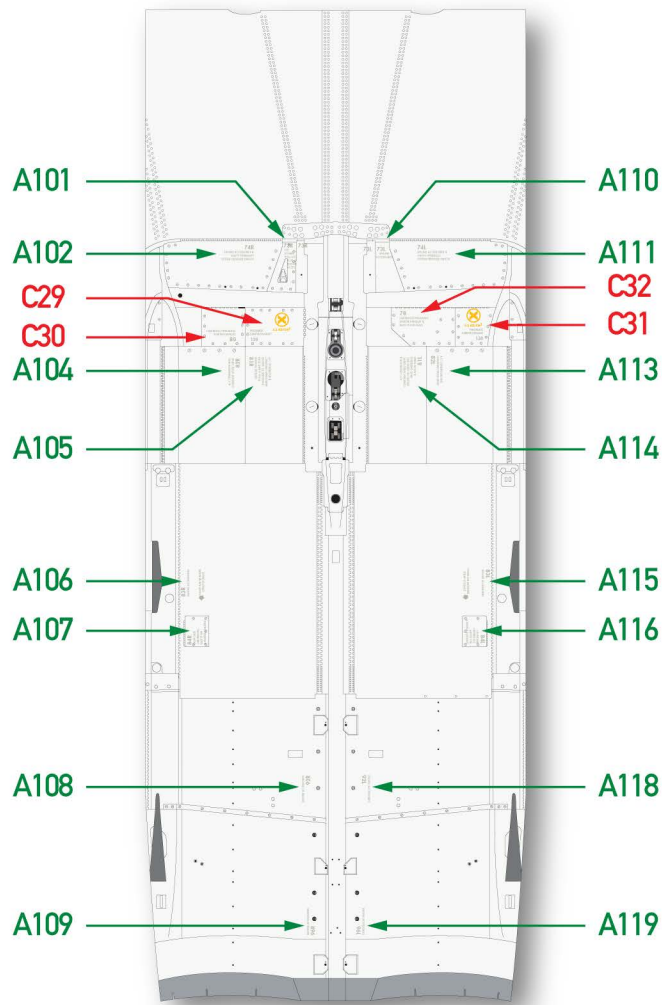

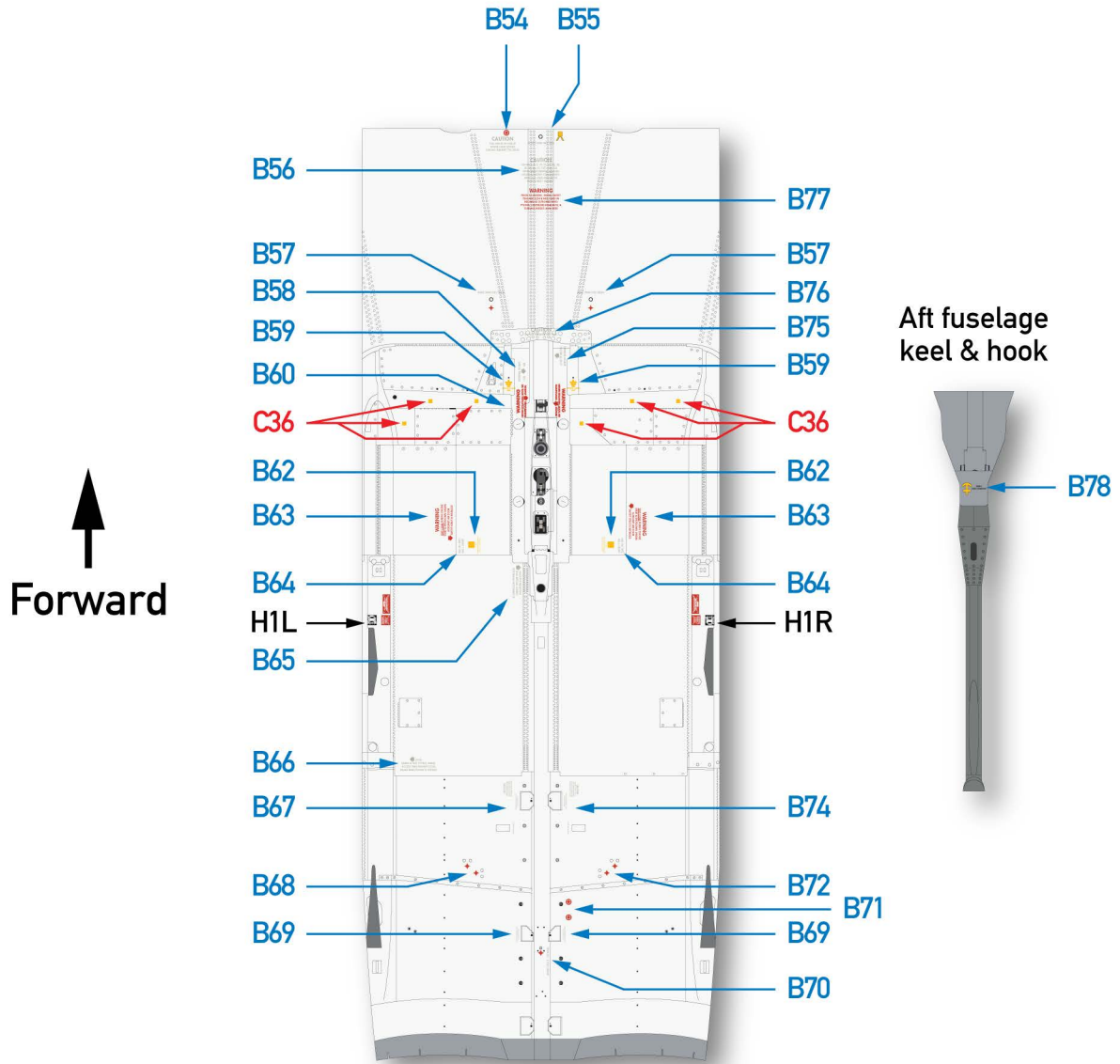

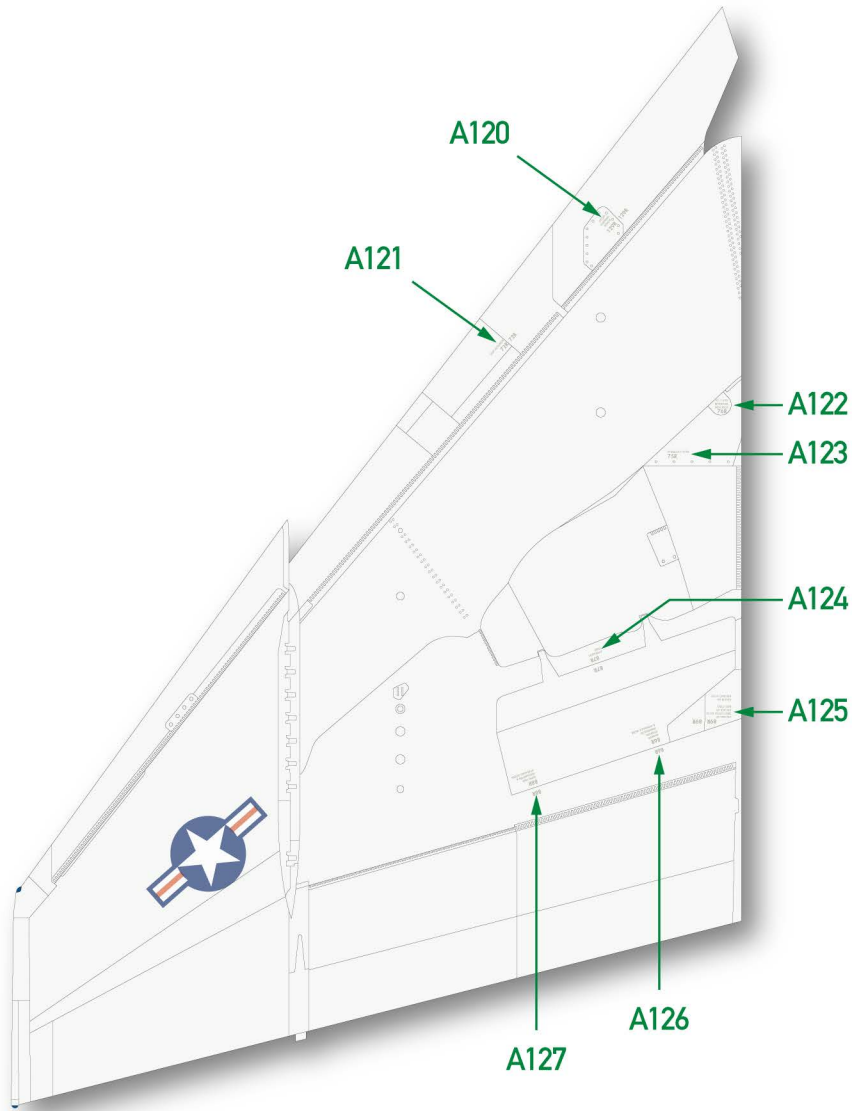

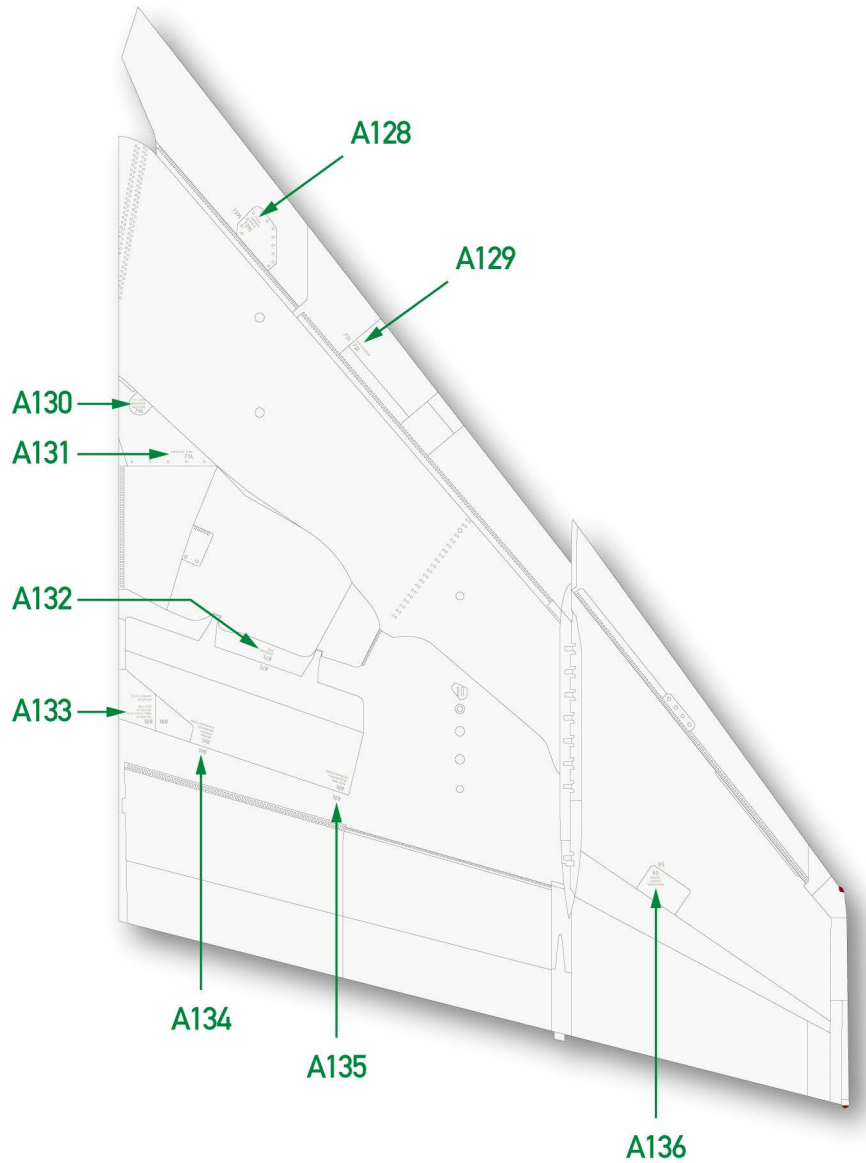

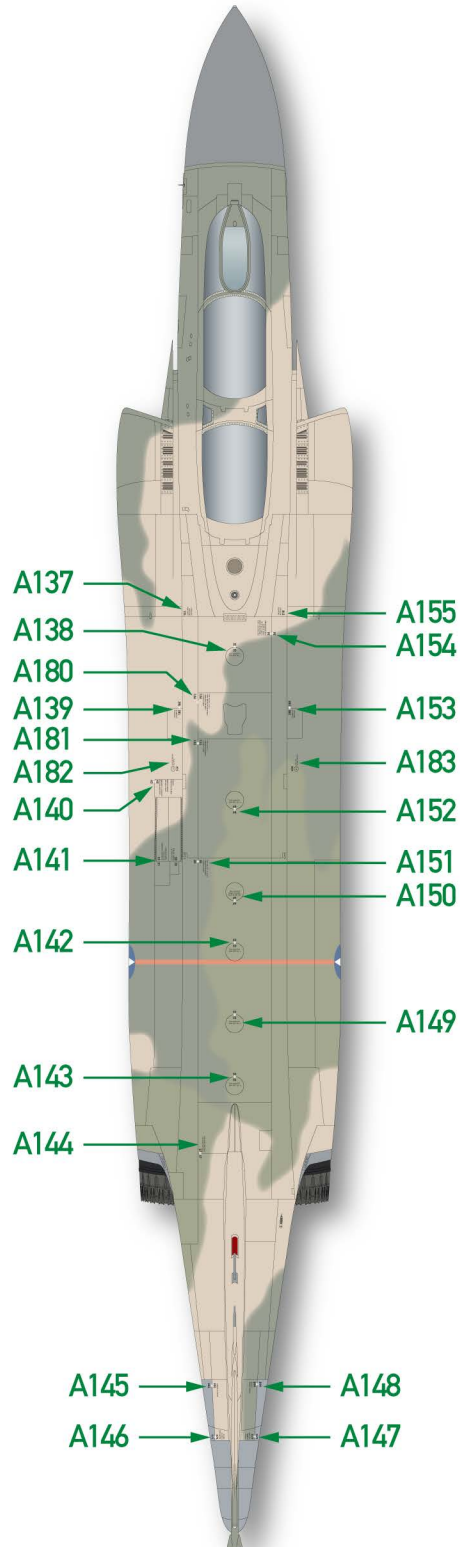

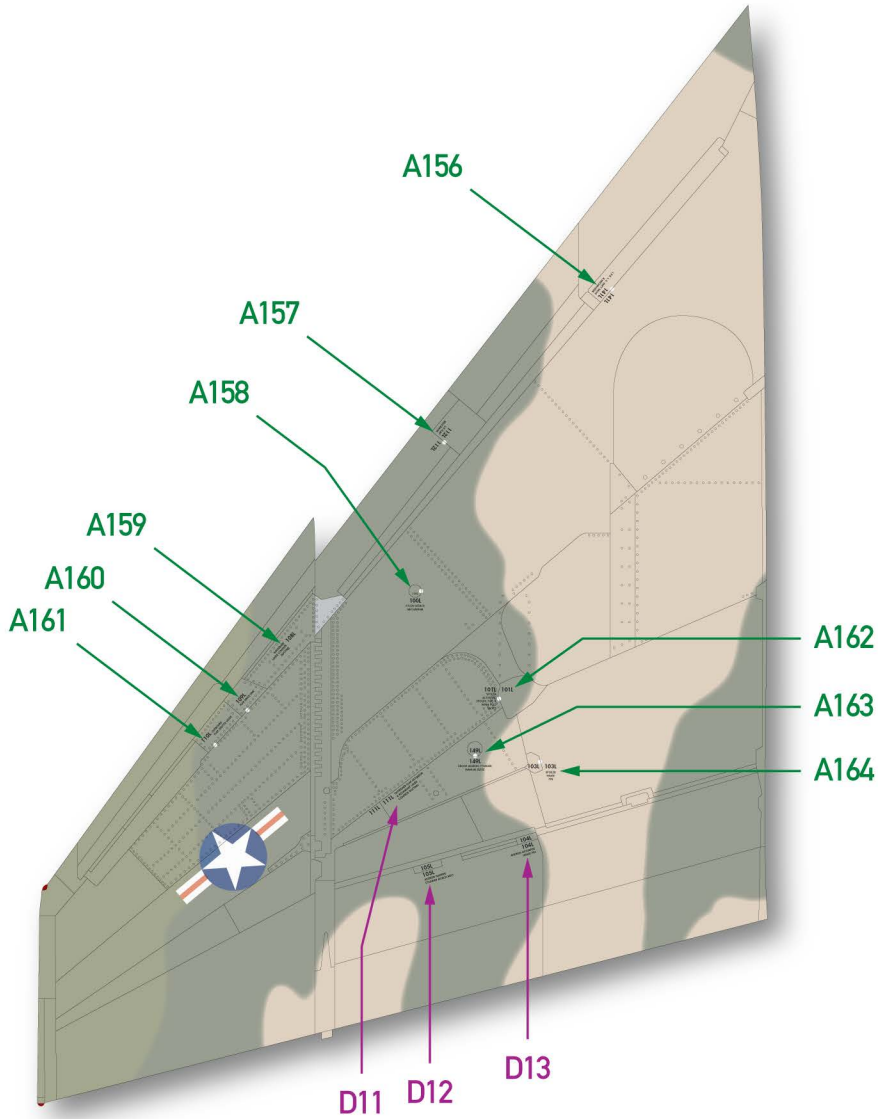

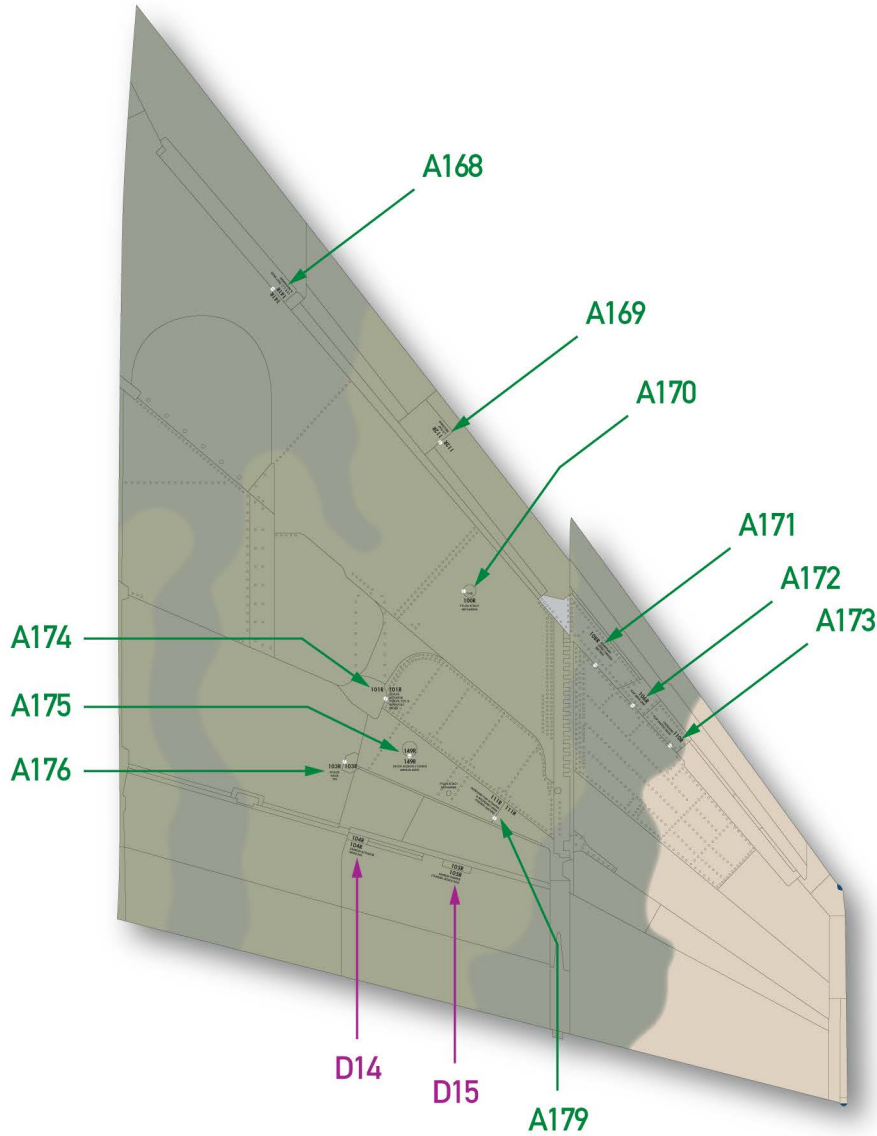

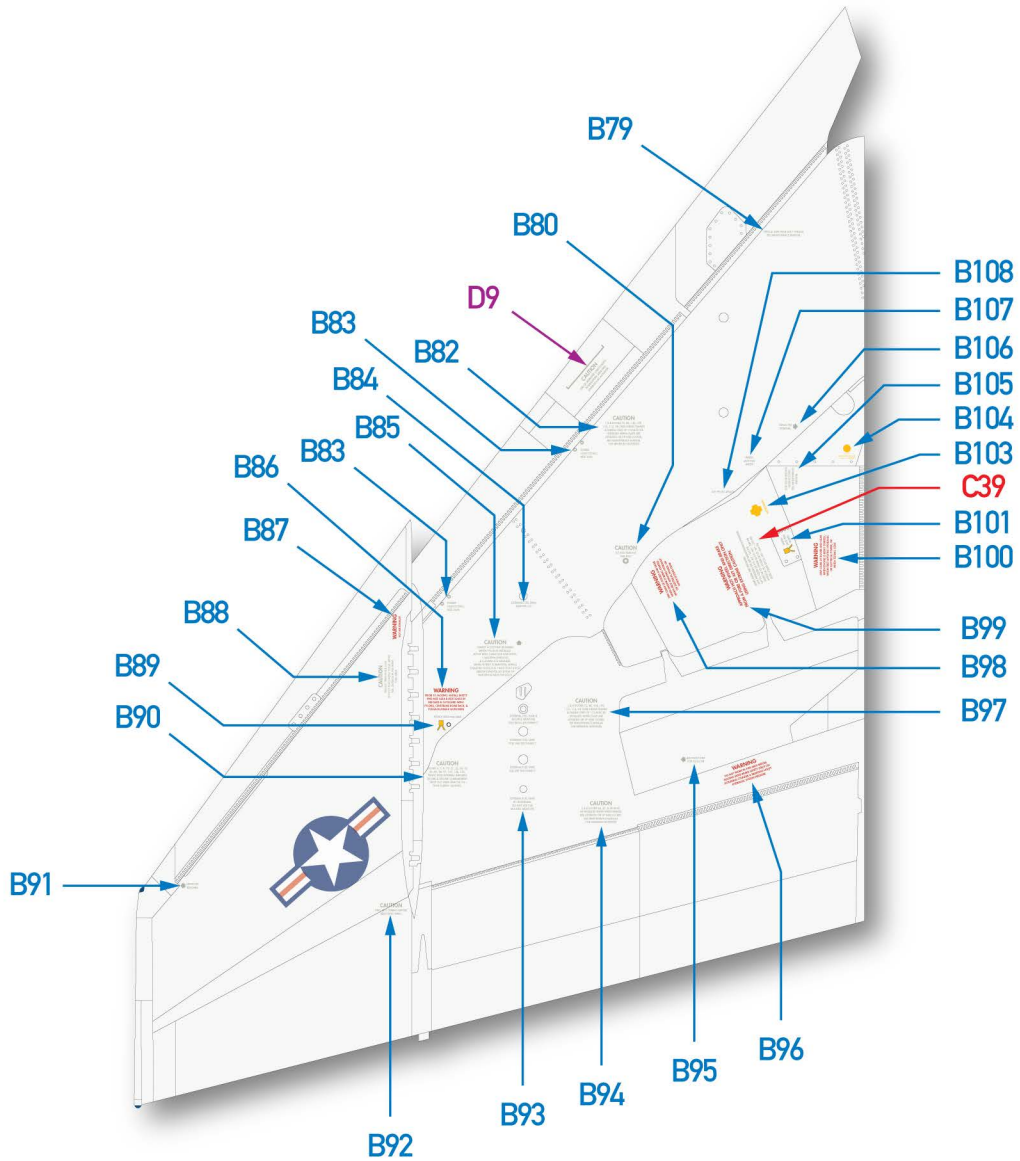

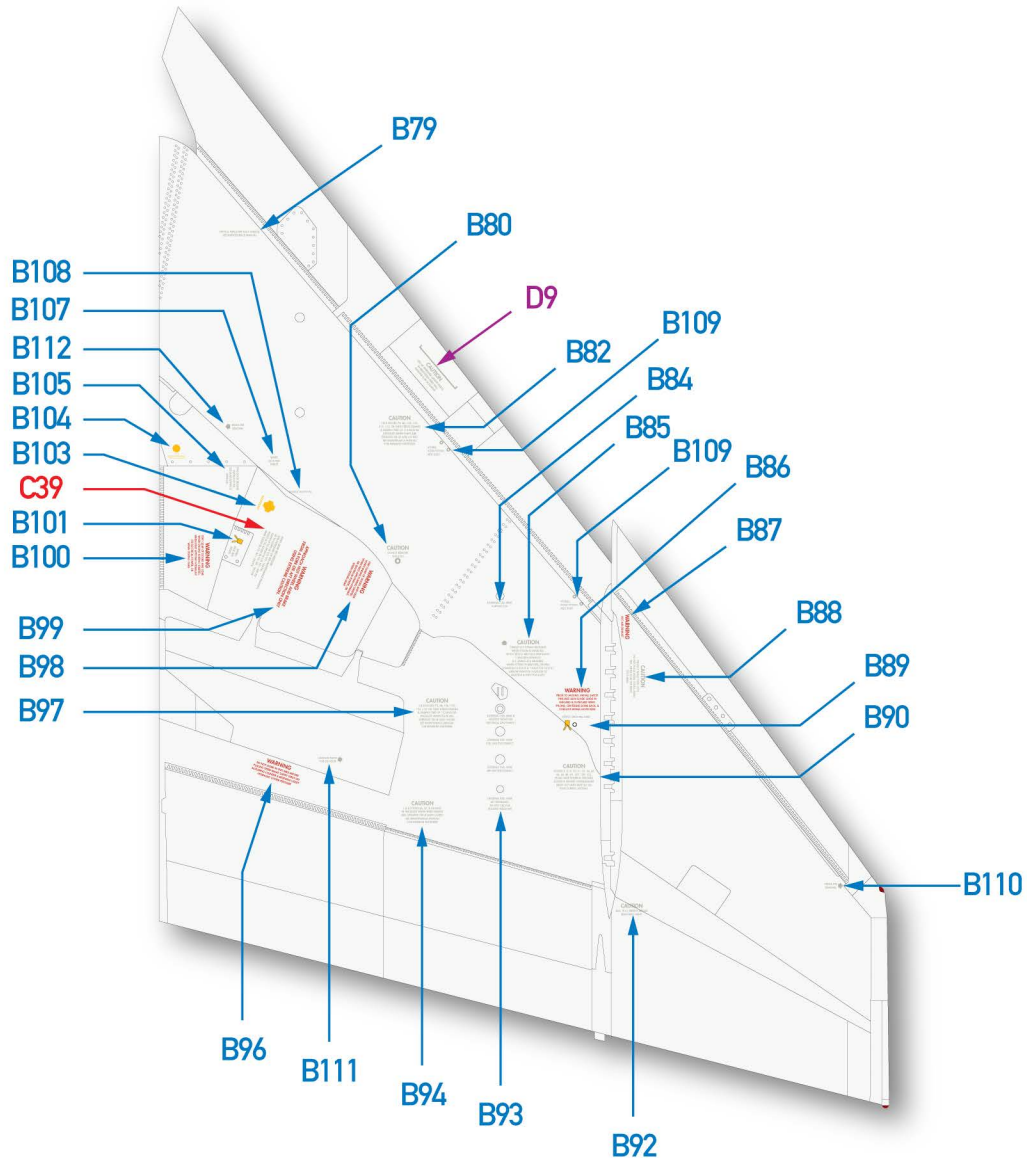

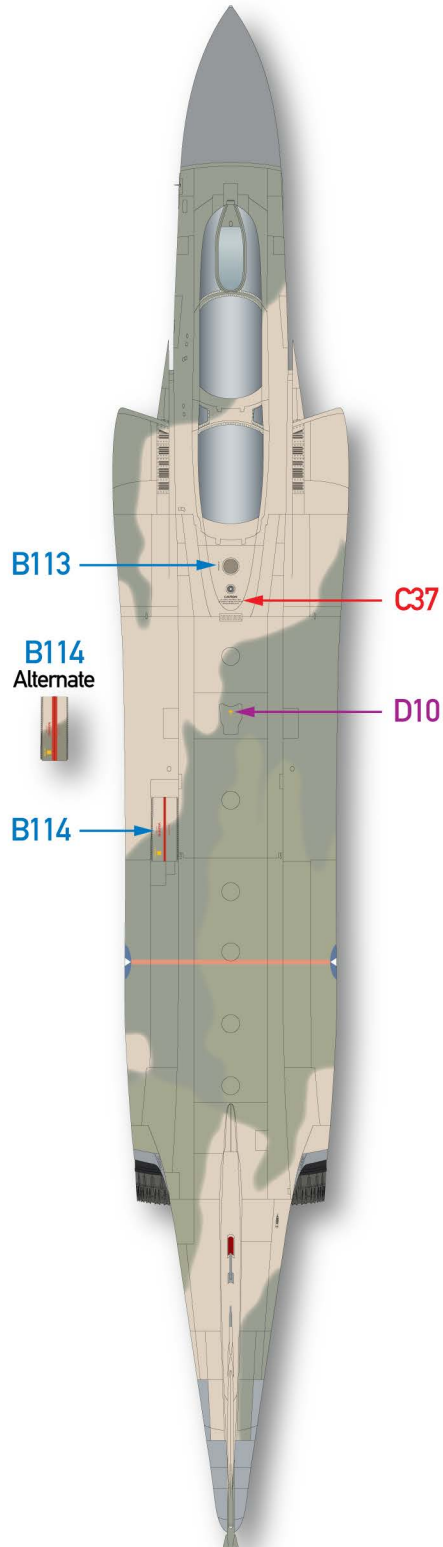

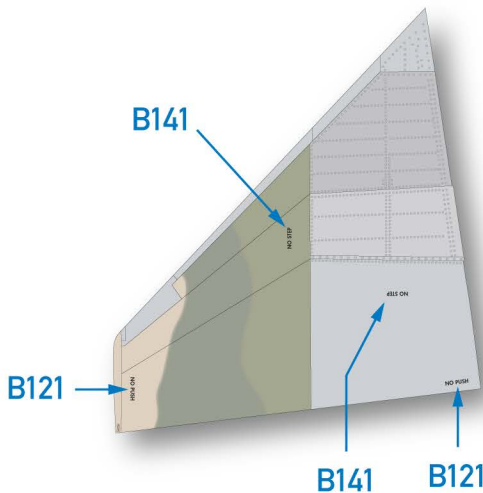
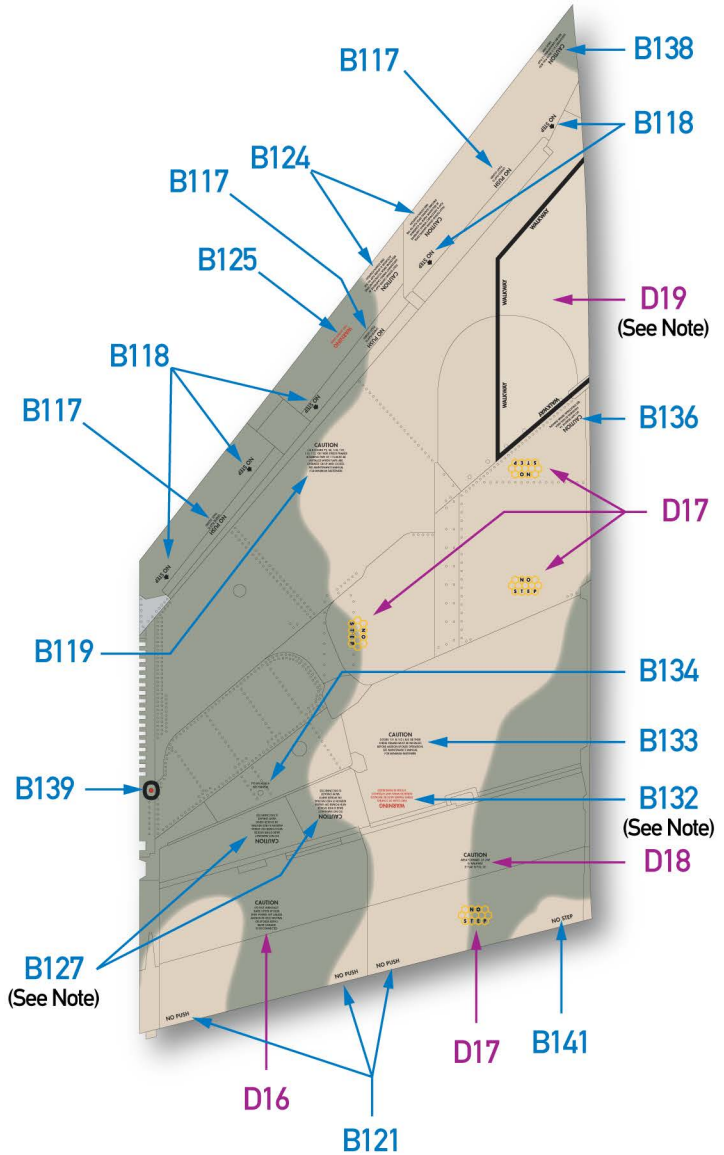
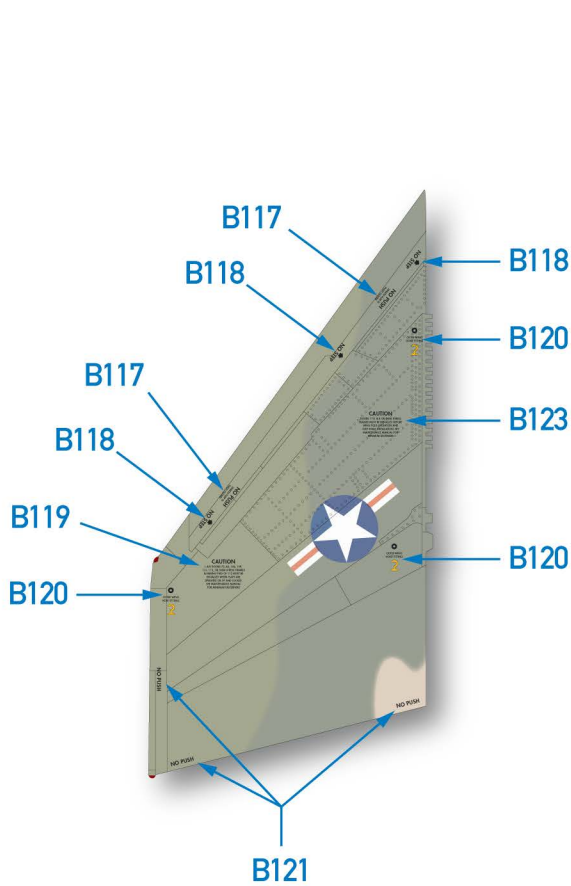

Notes:

D19/D20: When applied at the factory, the area inside the walkway outline was finished with tinted Corogard paint. In the few photos we have where you can clearly see this area on a factory finished aircraft, the left hand (tan) Corogard area appears to be slightly lighter in tone than the surrounding camouflage color, while the right hand one (green) appears darker. Of course it quickly became dirty with grime and boot marks.

B127/B132: Note the orientation of these items. Tops of letters face the trailing edge of the wing.

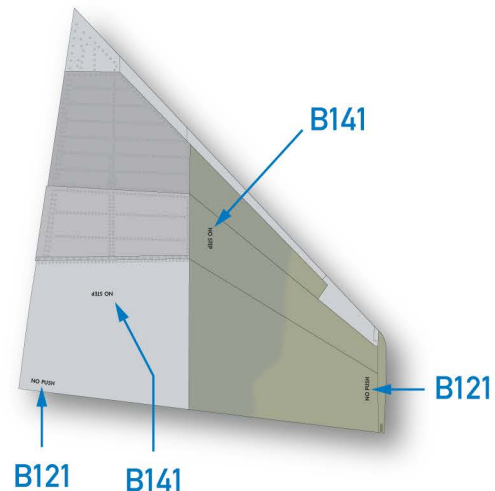
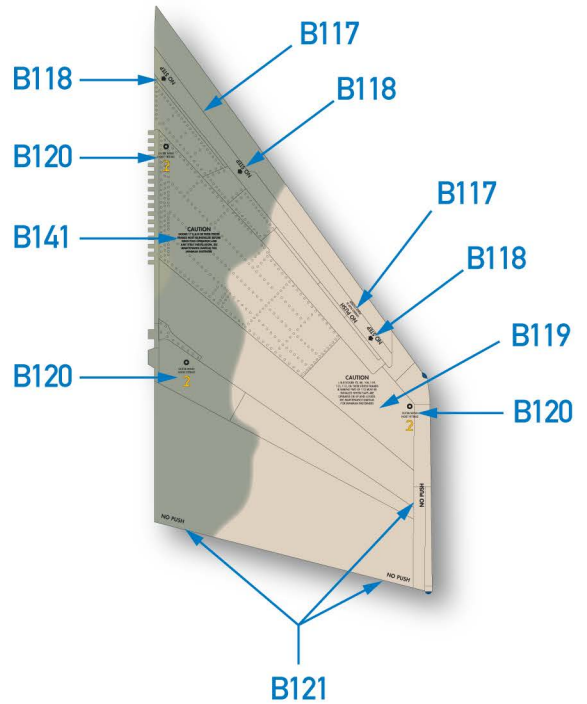
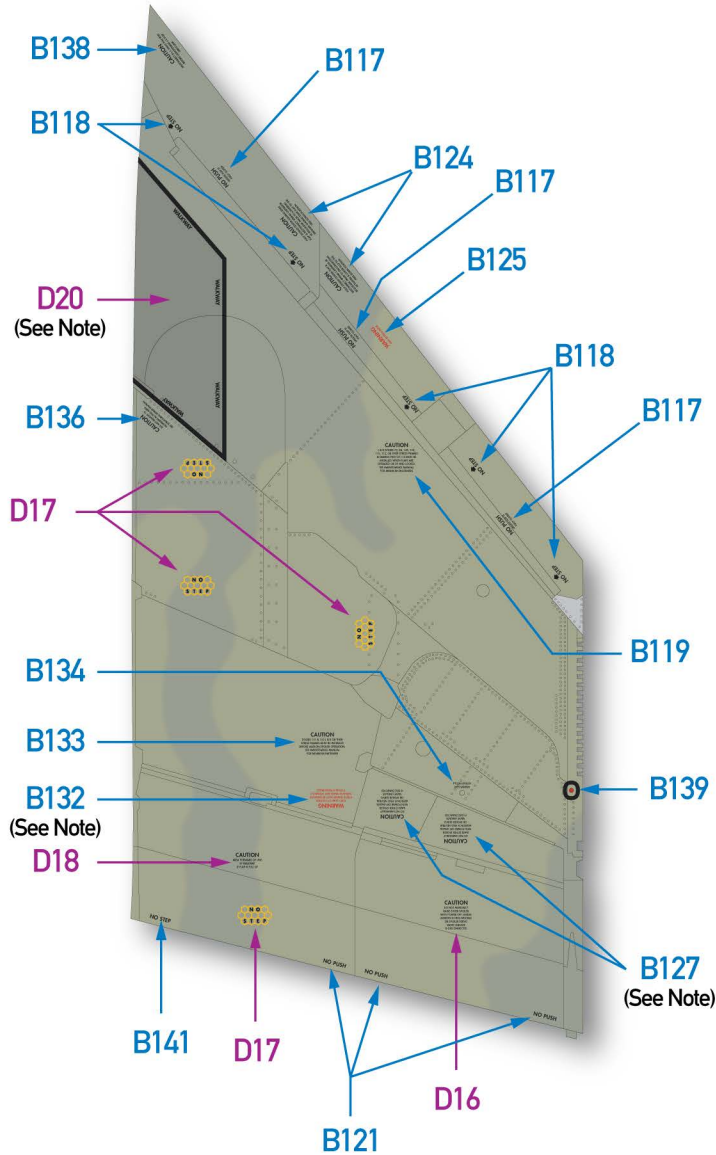

Notes:

D19/D20: When applied at the factory, the area inside the walkway outline was finished with tinted Corogard paint. In the few photos we have where you can clearly see this area on a factory finished aircraft, the left hand (tan) Corogard area appears to be slightly lighter in tone than the surrounding camouflage color, while the right hand one (green) appears darker. Of course it quickly became dirty with grime and boot marks.

B127/B132: Note the orientation of these items. Tops of letters face the trailing edge of the wing.

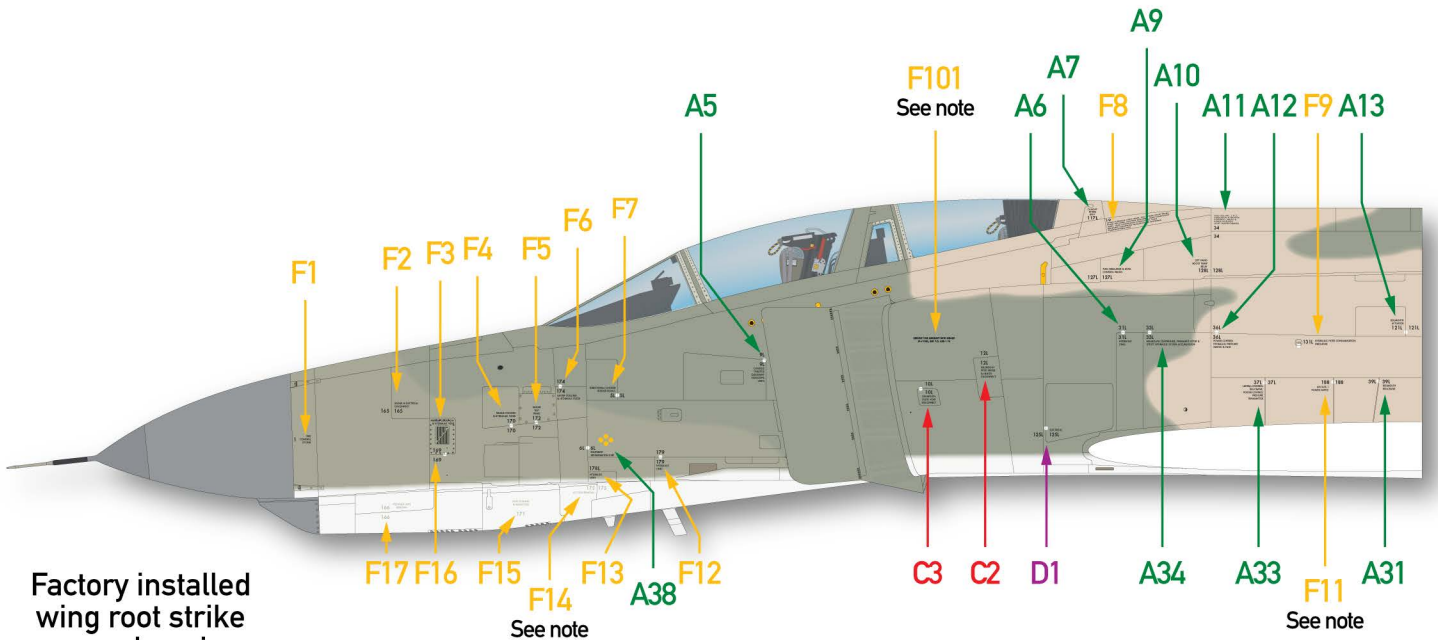

Factory installed wing root strike camera housings

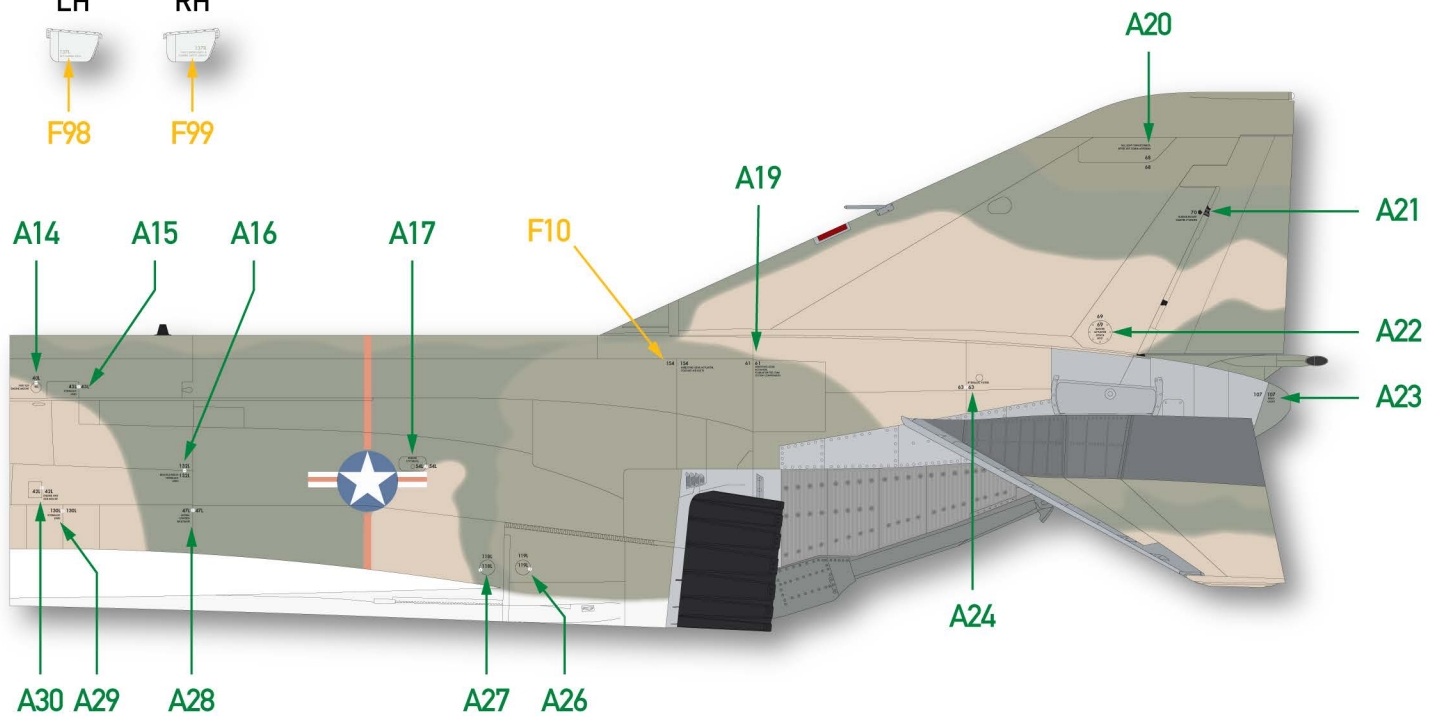

Notes:

F11: Only applied to F-4E-48-MC 71-0237 (factory installed slatted wing and TISEO equipped) and higher serials.

F14: Probably applied to early F-4Es up through Block 45 (USAF 69-7589 and lower), but this remains to be positively verified. See notes on following pages regarding other variations of this item.

F98/99: Factory installed strike cameras under the wing roots appear to have been implemented with Block 46 (USAF 69-7711 and higher), but this remains to be positively verified. It is certain they were fitted on Block 47 aircraft (USAF 69-7727) and all subsequent serials.

F101: This portion of the standard aircraft data block was applied on export aircraft. On USAF aircraft, there were two lines above it giving the production block number and USAF serial. Stencils applied to export F-4Es were identical to US F-4Es, including those with unique camouflage schemes such as Iran and Israel. The only exception was the few late F-4Es delivered with Ghost Gray camouflage, which are not covered here.

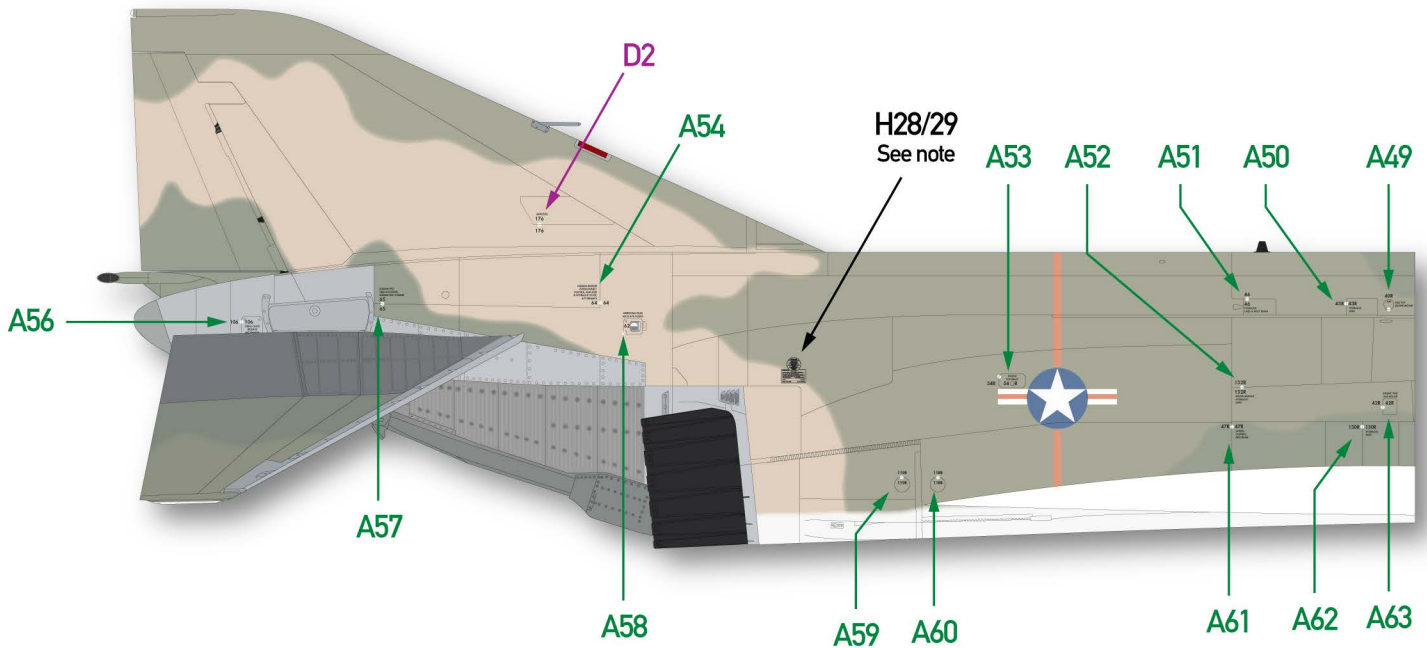
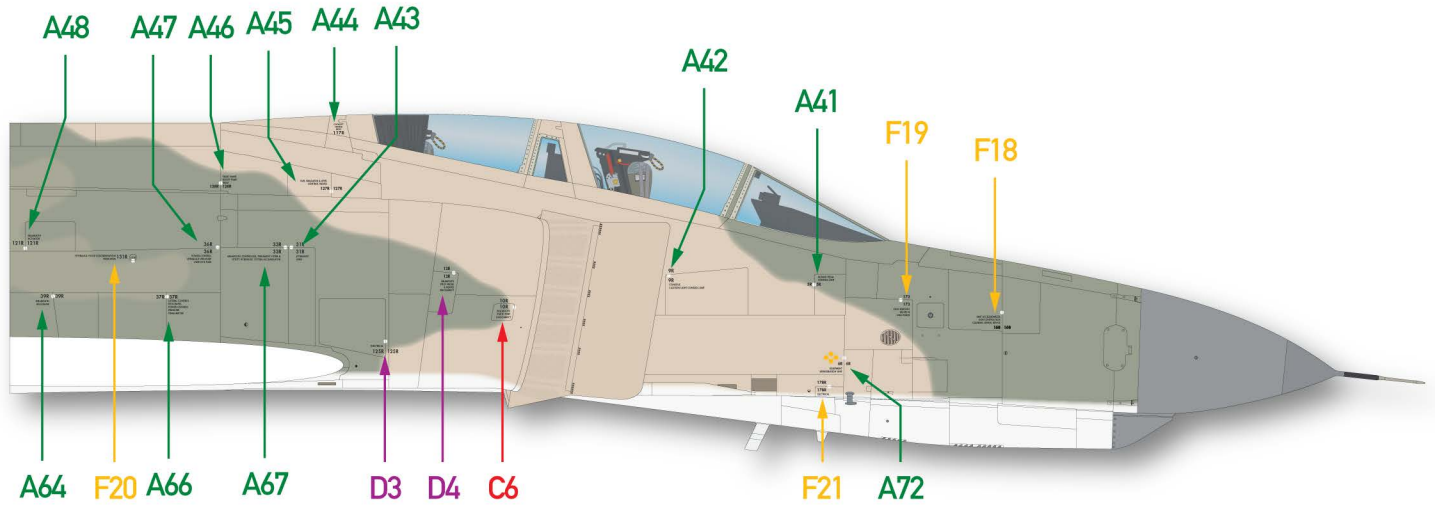

Note: Decals H28 and H29 were not always applied. H28 is for aircraft built by McDonnell, while H29 is for aircraft built by McDonnell Douglas after the 1967 merger.

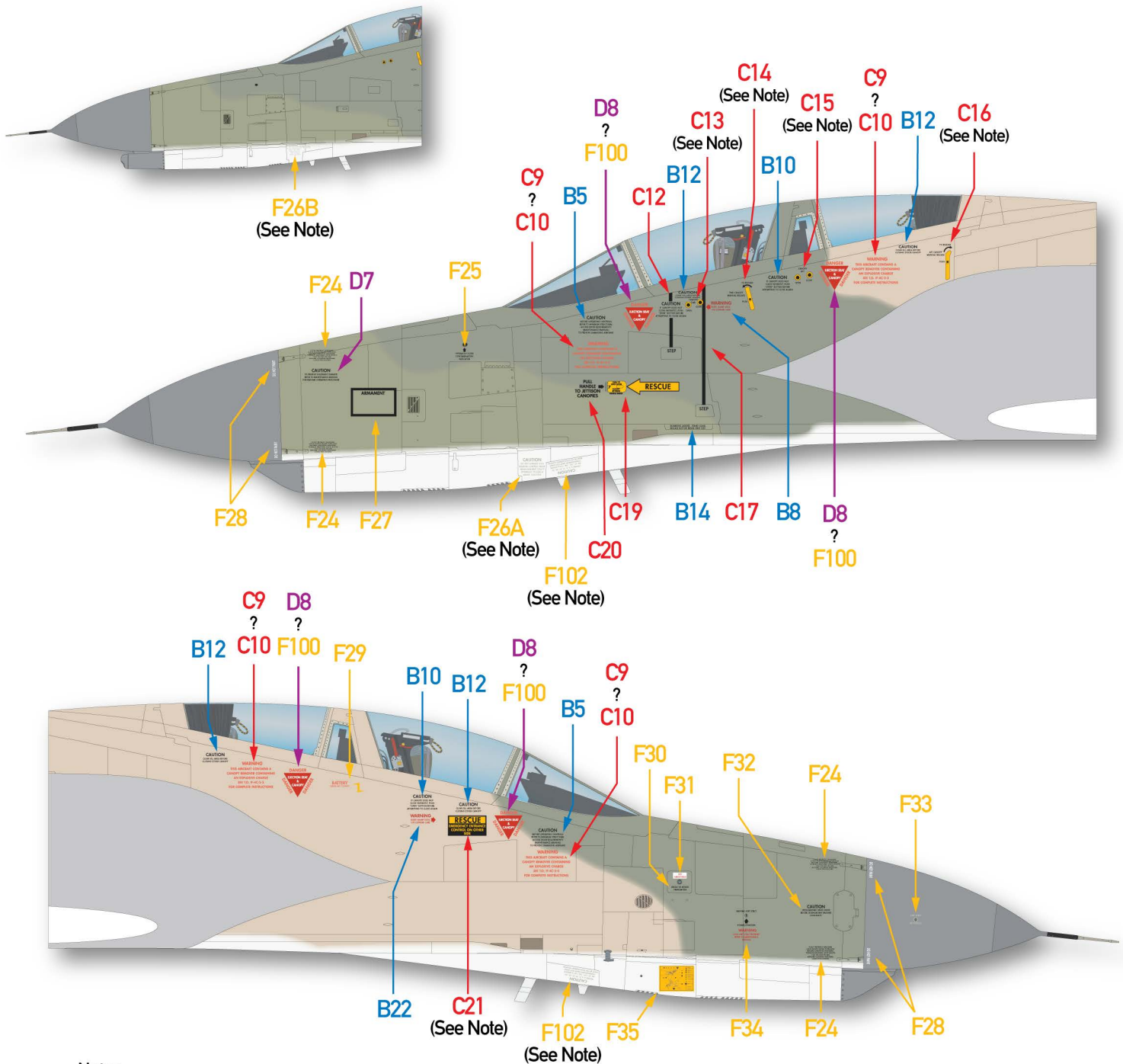

Notes:

C9/C10: The salmon colored stencil (C9) was most commonly used, but the bright red version (C10) was also applied on some aircraft.

C13 - C16: Canopy open/close buttons & handles are provided to fit the ZM and Tamiya kit scribing (as closely as can make them), as well as in the actual scale size and shape based on tracings and measurements of these items on an actual F-4. The kit scribing (on every existing 1/48 F-4 kit we have found) is not really accurate in size or shape. We recommend filling the scribed detail and using the "B" versions of these decals, which are accurate scale representations of the real thing.

C21: Two variations are provided. The one shown in the drawing is by far the most common.

F26A/B: This was applied in place of F14 on later block F-4Es, but precise change over points for each version have not been positively established. As a rough guide, use F14 on aircraft up through Block 45, F26A on Blocks 46-47, and F26B on Block 48 and higher.

F102: This seems to have only applied to early F-4E production blocks, but we do not have a specific block or serial when it was deleted.

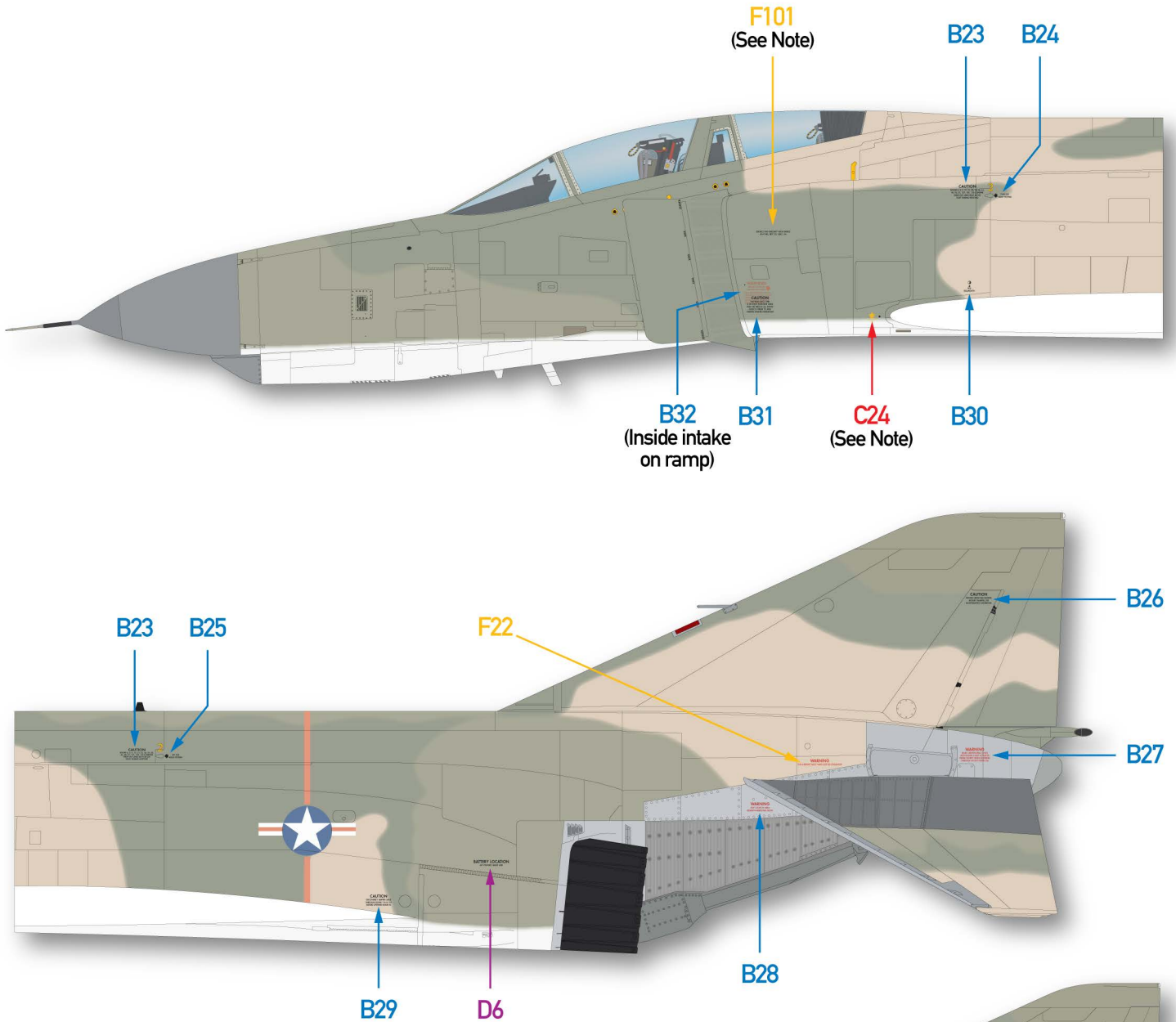

Notes:

C24: This was not applied to early F-4Es (which lacked the grounding plug in this position). It was applied to later block aircraft, but we have been unable to determine precisely when it was first installed on the production line, but to date, the earliest serial we can positively identify it on is F-4E-48-MC 71-0234.

F23A/B: Applied to F-4E-37-MC 67-0342 and subsequent. The configuration shown was most common, although the version with the red arrow touching the white rectangle was seen sporadically as well.

F101: This portion of the data block was applied to all aircraft, even on exports where the two larger lines of type (ex. U.S. AIR FORCE F-4E-39-MC, A.F. SERIAL 68-426A) were not applied.

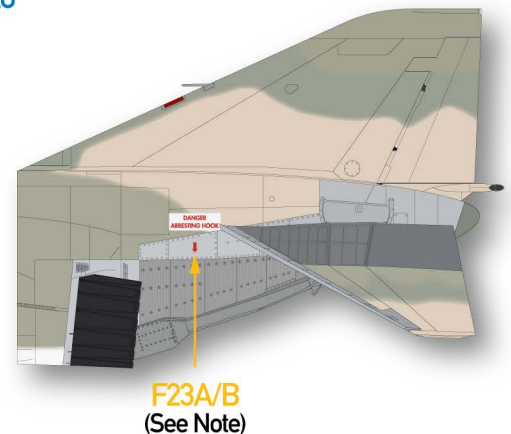

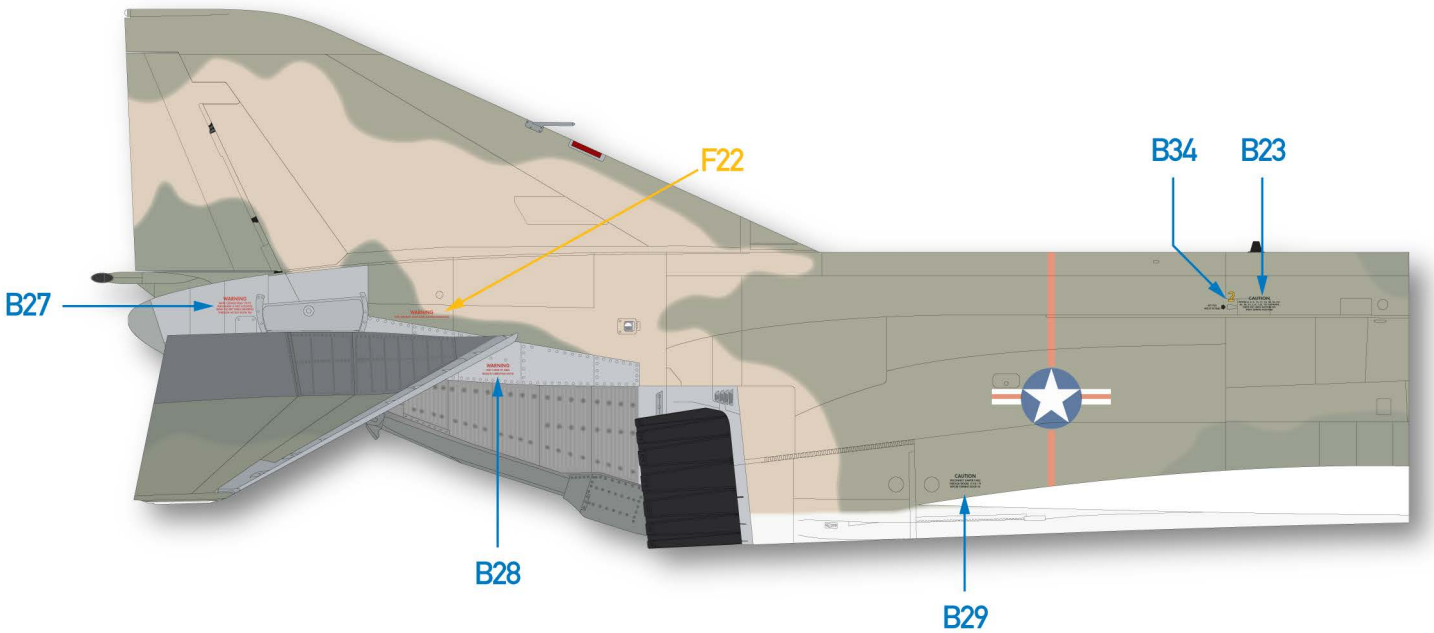
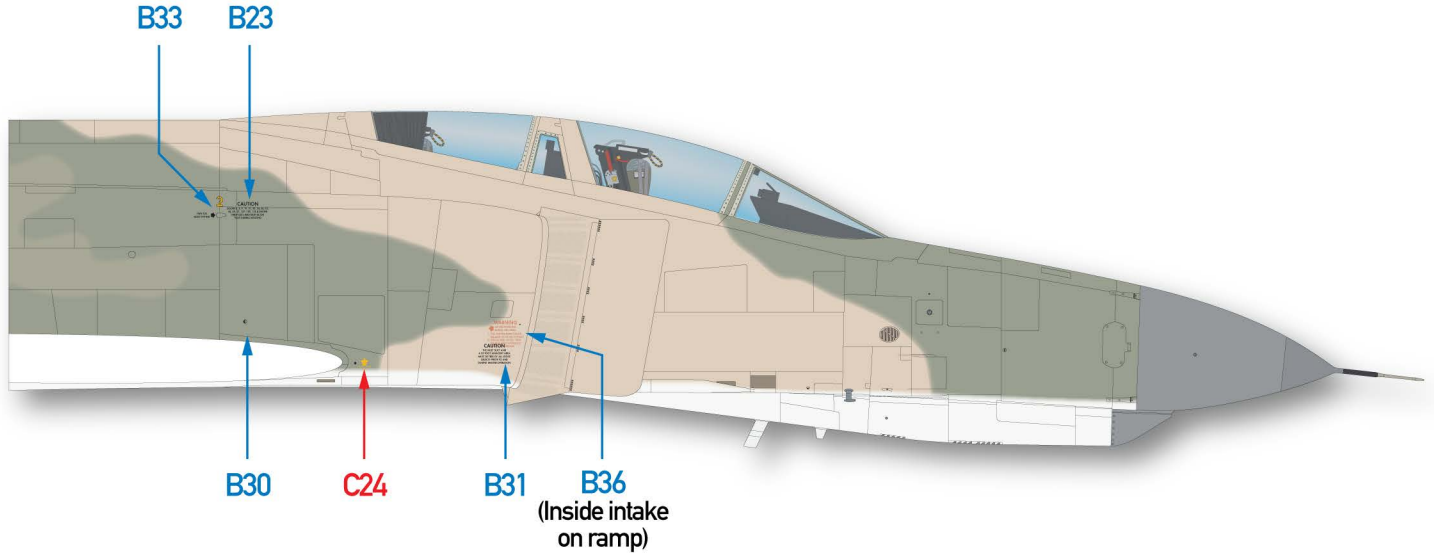

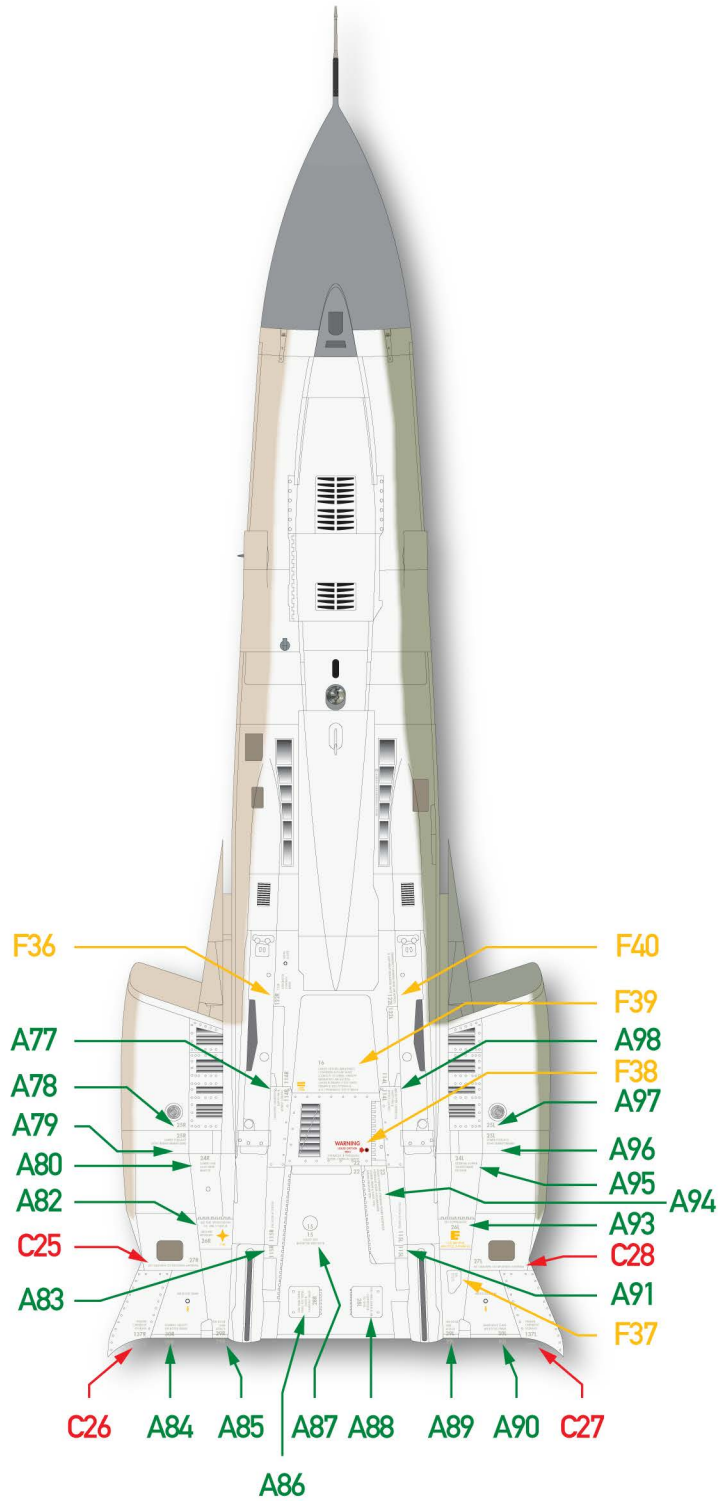

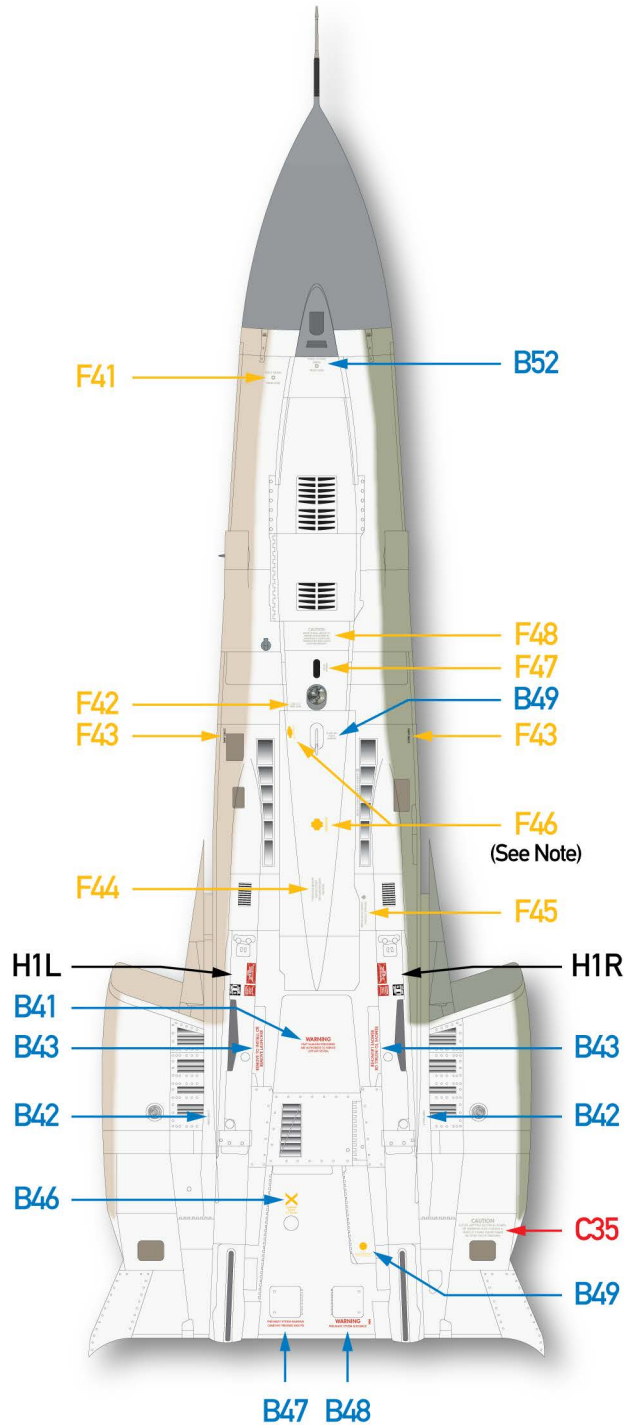

Notes:

Decal C34 omitted intentionally.

F46: Both locations were common, but marking was only applied in one or the other location, not both. We do not have a specific block or serial, so check references.

↑
Forward

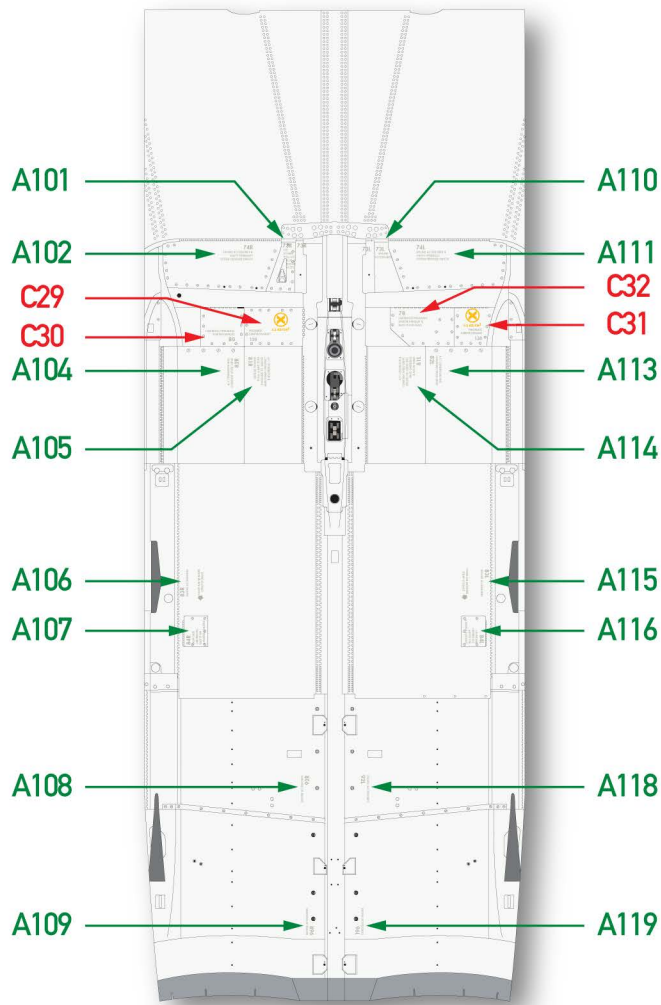

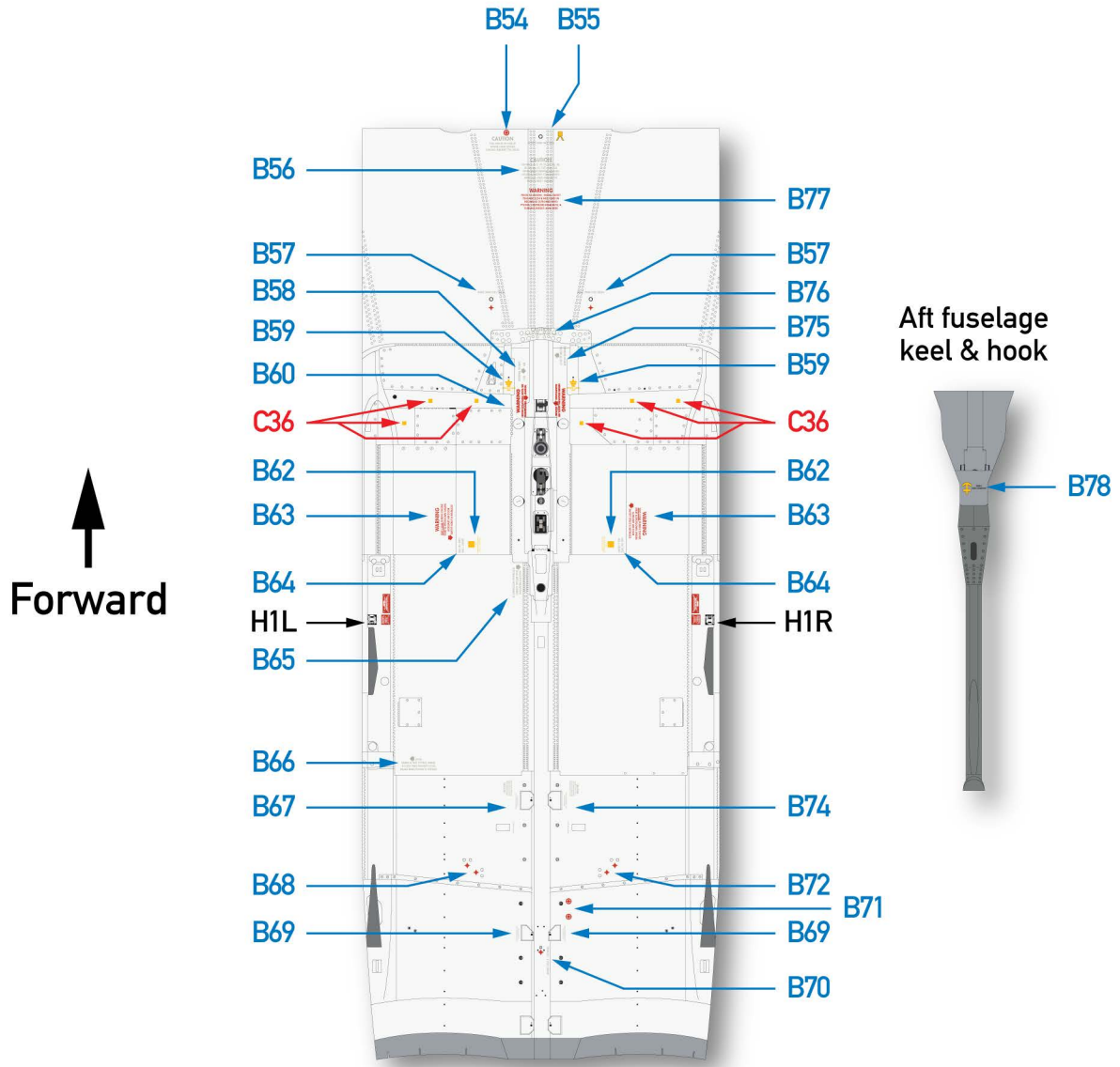

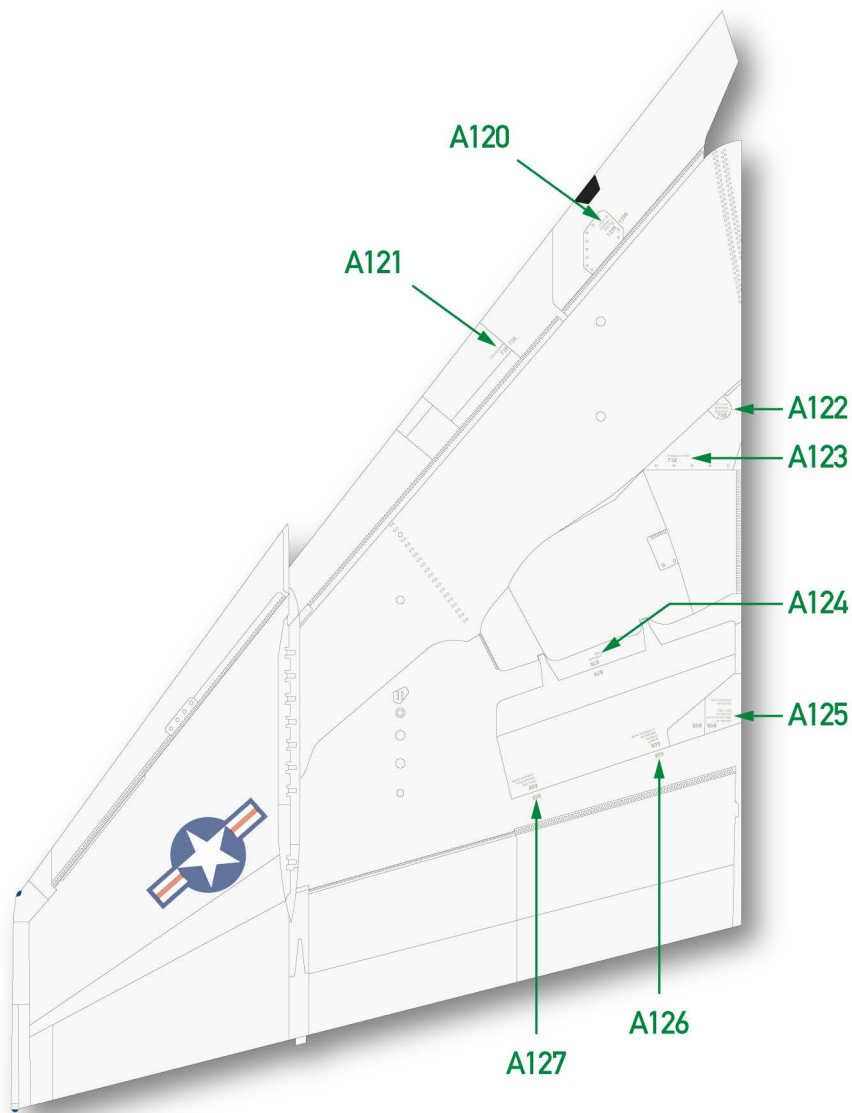

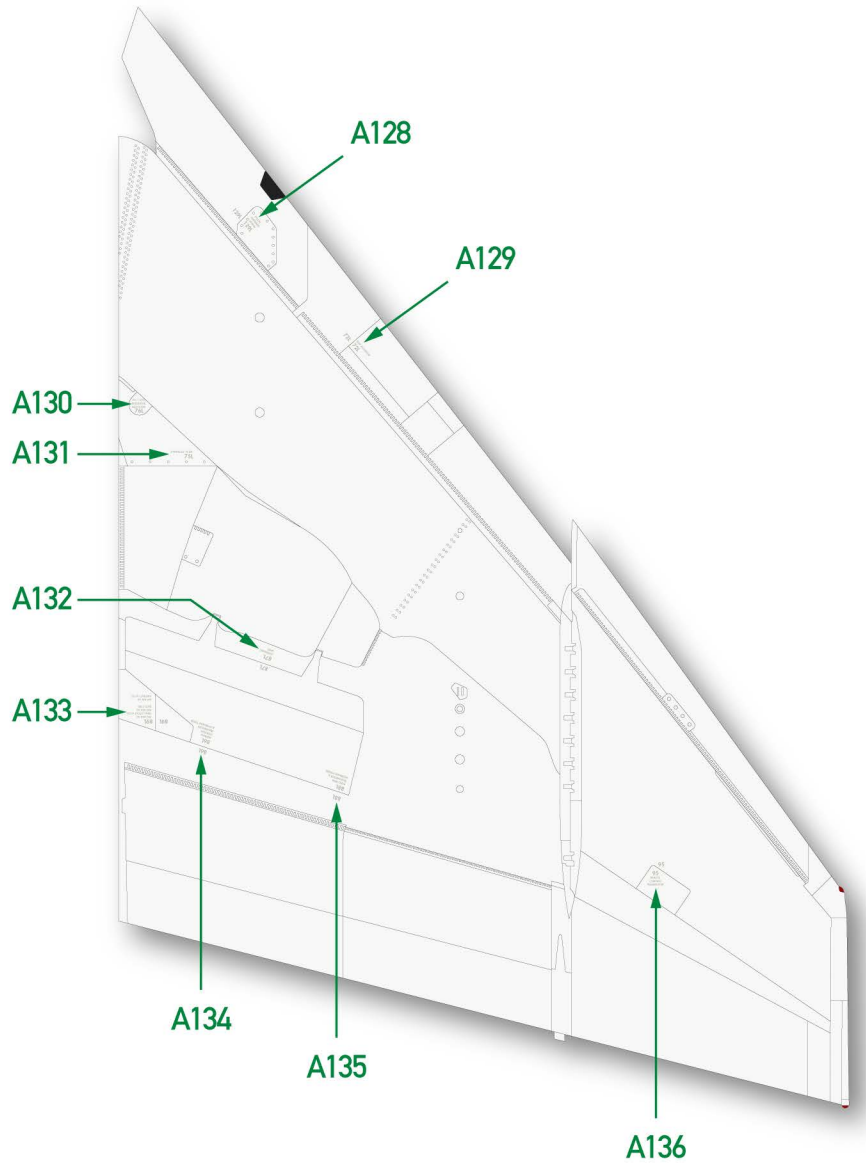

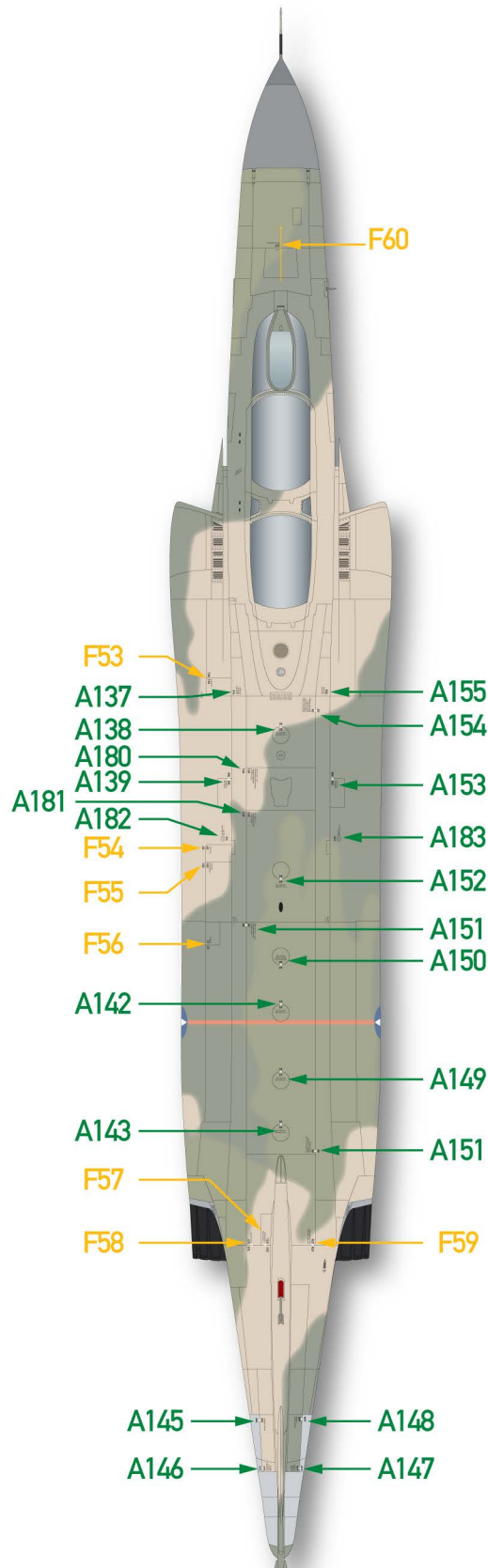

Note:

F75A: 66-0284 - 67-0207

F75B: 67-0208 - 69-7589

F75C: 71-0224 - 71-0236

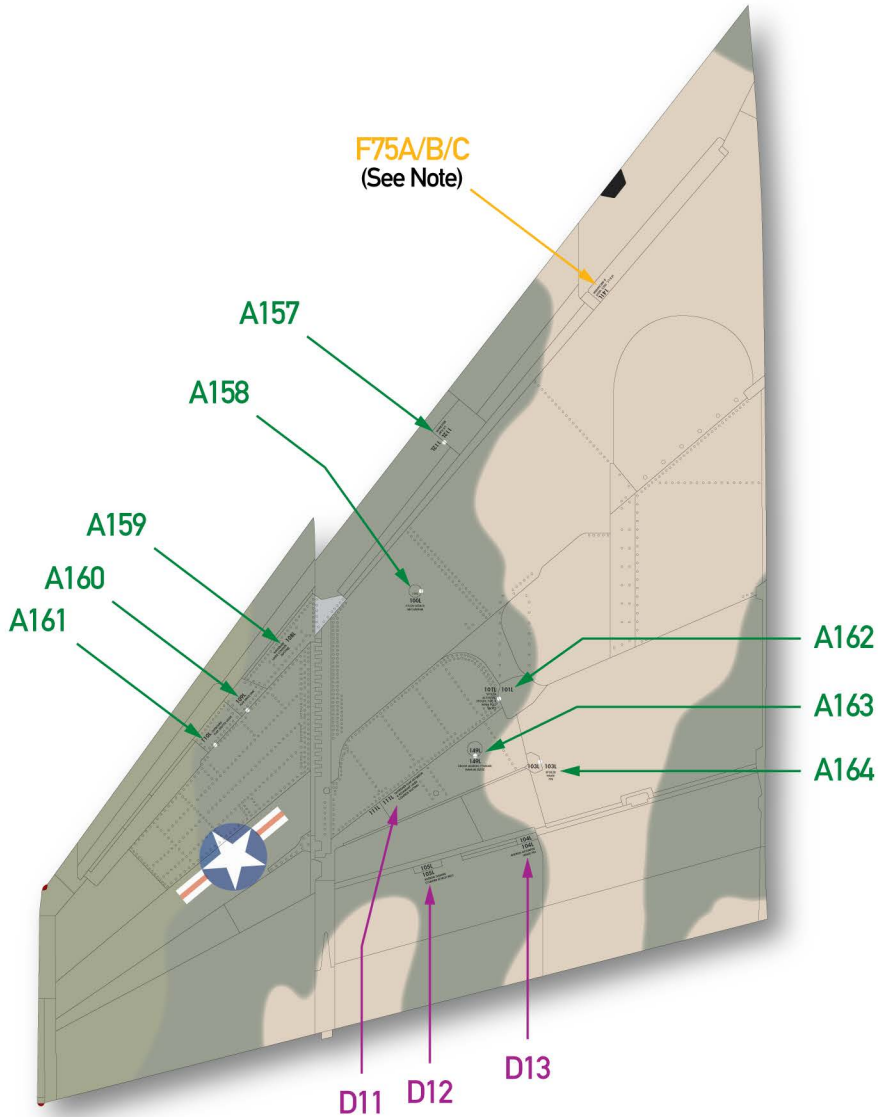

Note:

- F86A: 66-0284 - 67-0207
- F86B: 67-0208 - 69-7589
- F86C: 71-0224 - 71-0236
- F86D: 71-0237 & higher

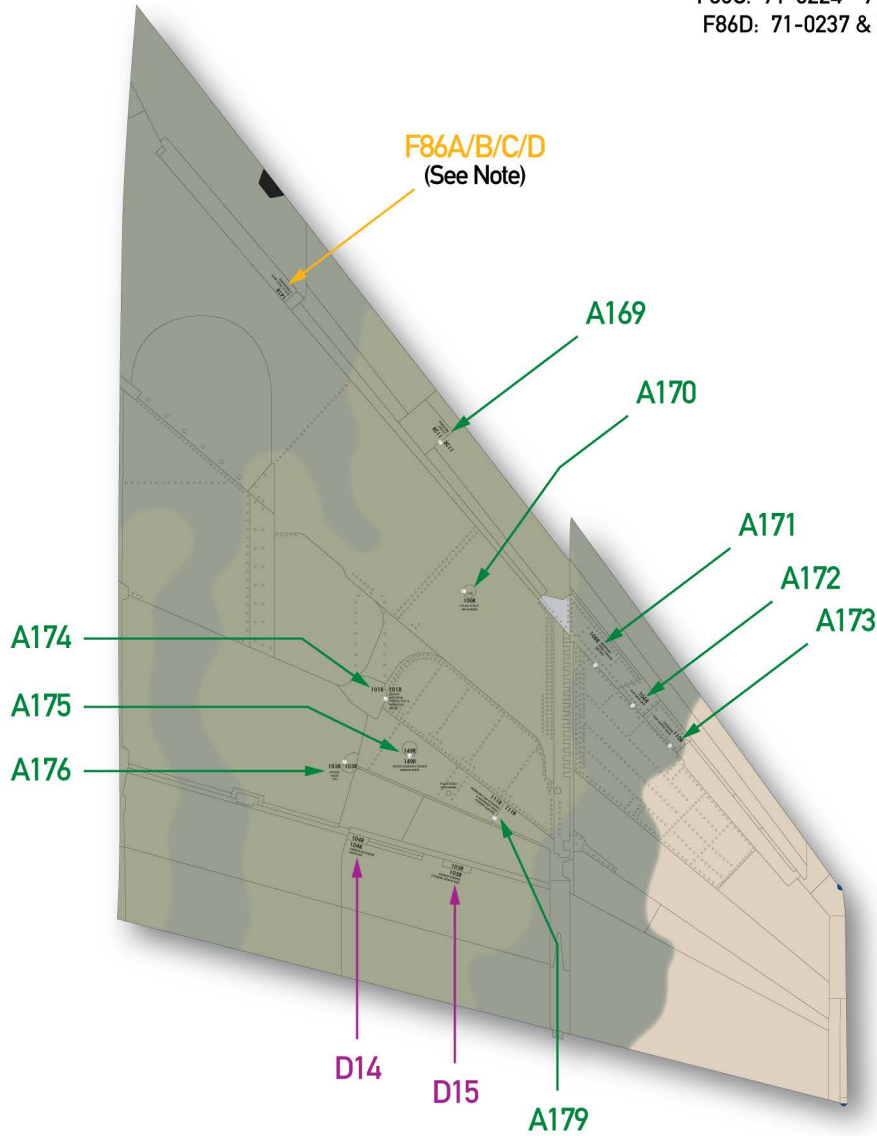

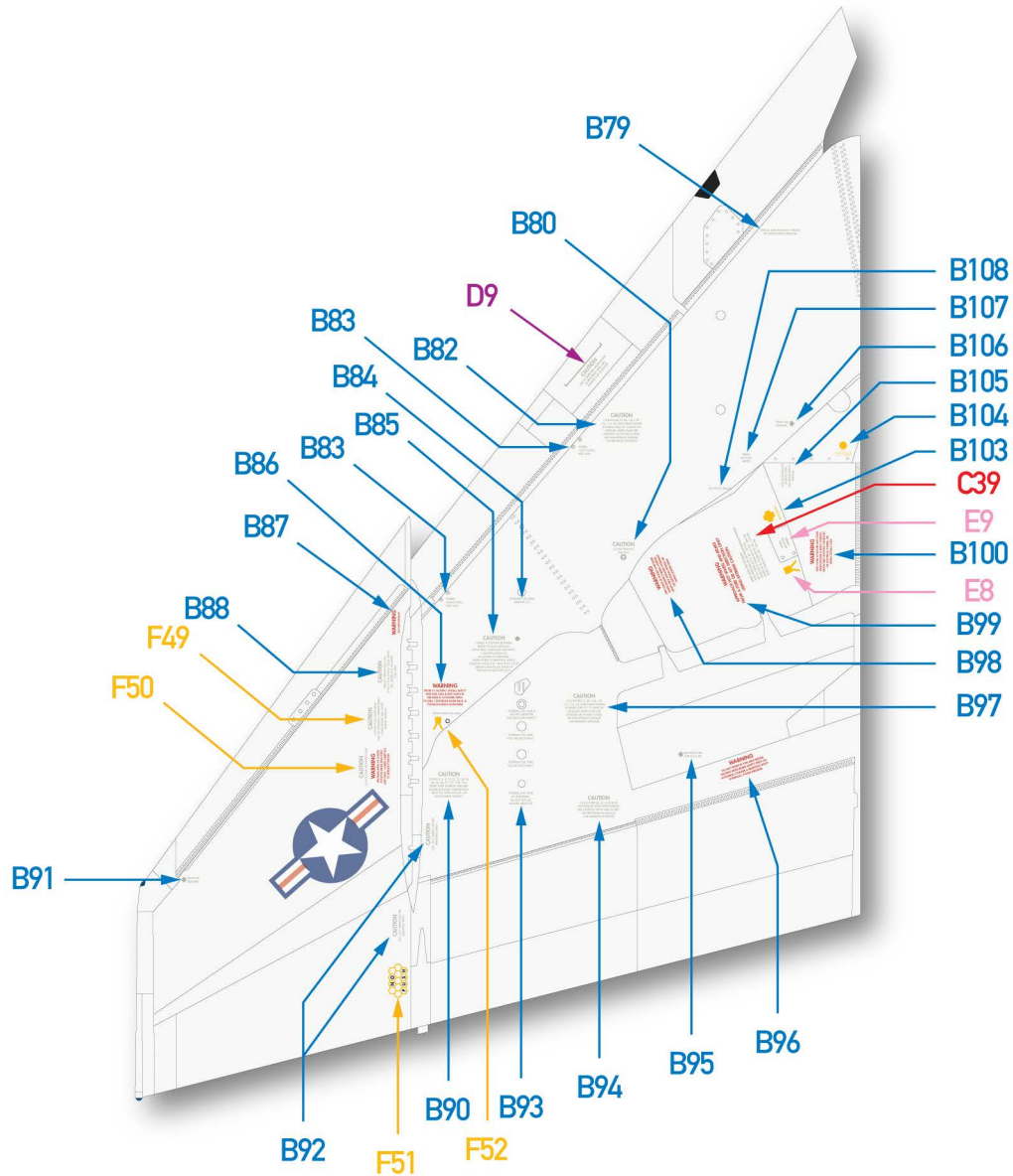

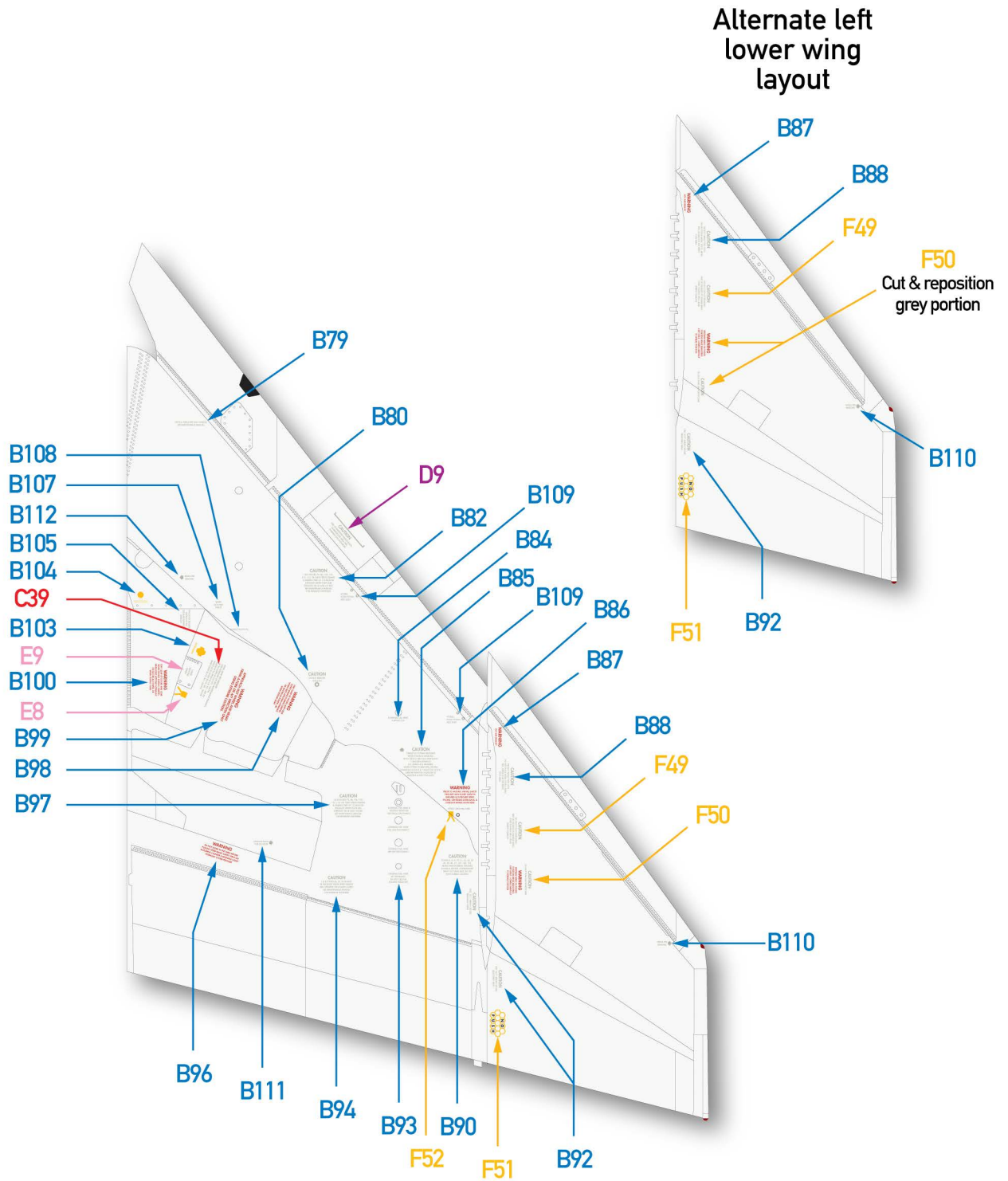

Gun gas purge intake door
variations in application of
warning marking F62

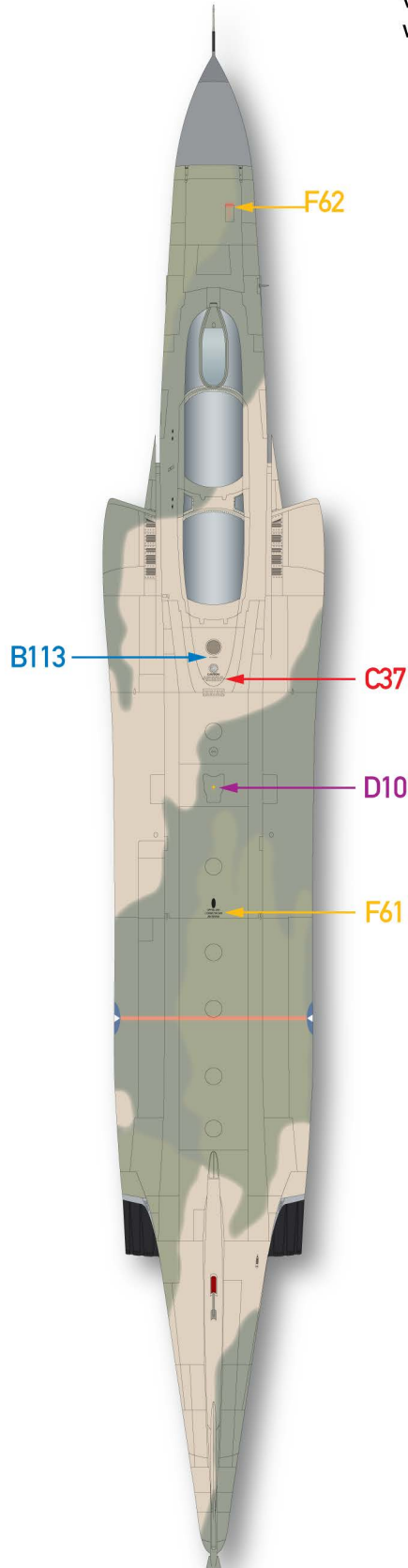

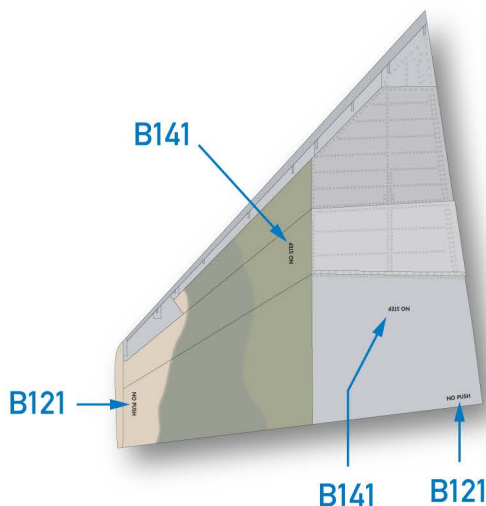
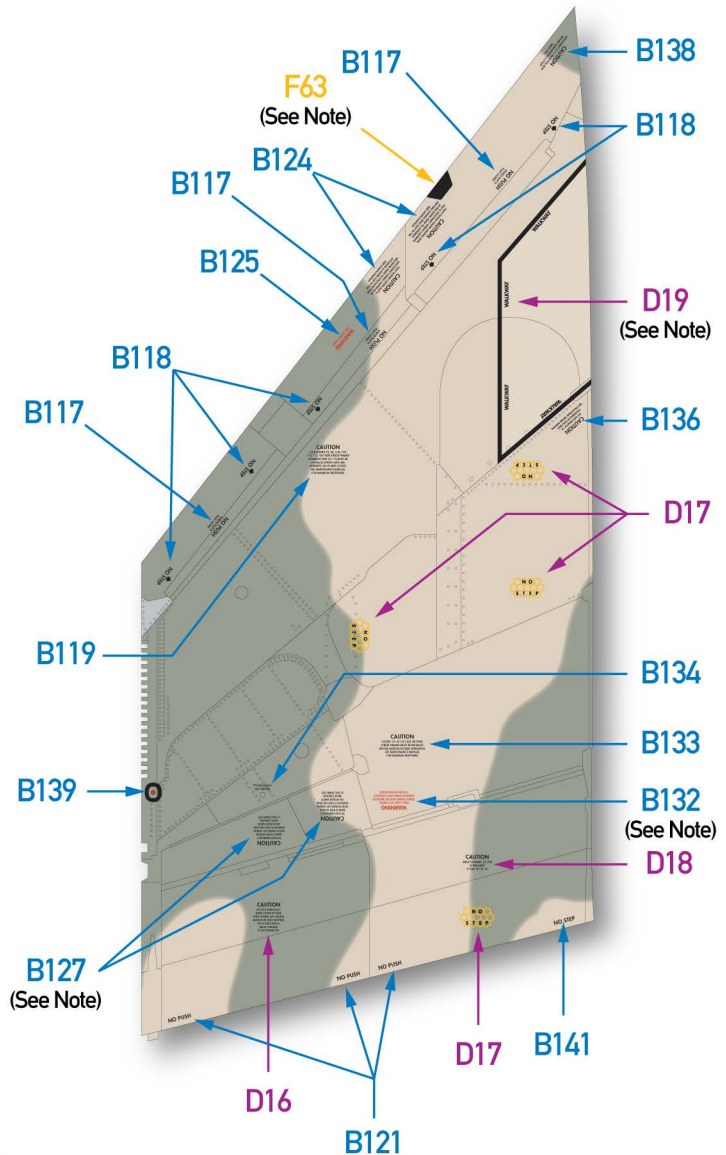
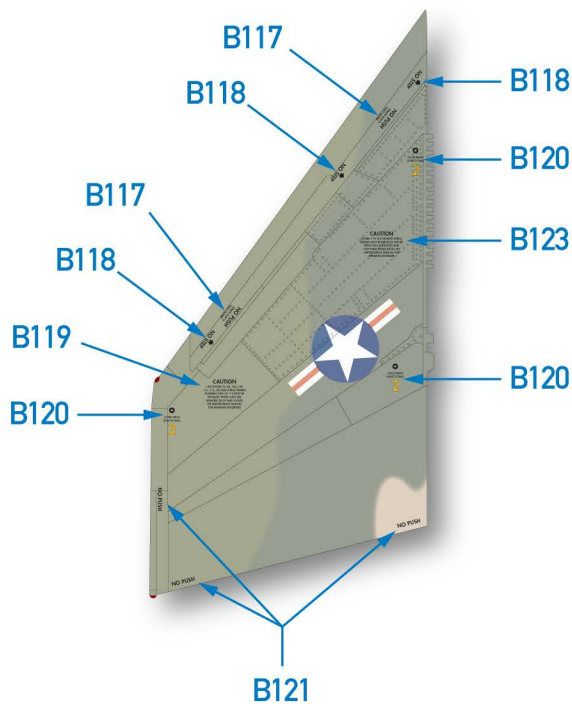

Notes:

B127/B132: Note the orientation of these items. Tops of letters face the trailing edge of the wing.

D19/D20: When applied at the factory, the area inside the walkway outline was finished with tinted Corogard paint. In the few photos we have where you can clearly see this area on a factory finished aircraft, the left hand (tan) Corogard area appears to be slightly lighter in tone than the surrounding camouflage color, while the right hand one (green) appears darker. Of course it quickly became dirty with grime and boot marks. We are not certain of the change over date to the later style (decals F96/F97), but we believe it was prior to serial number 71-0237 with the slatted wing. Check your references.

F63/F64: Note orientation of these items. Only found on hard wing F-4Es and F-4Js. Retained even after slats were retrofitted, though sometimes overpainted on F-4G conversions.

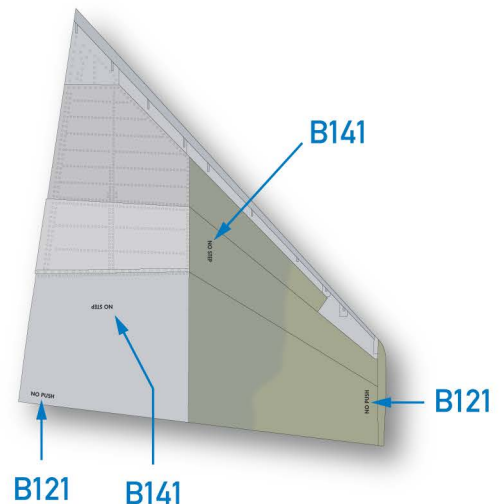
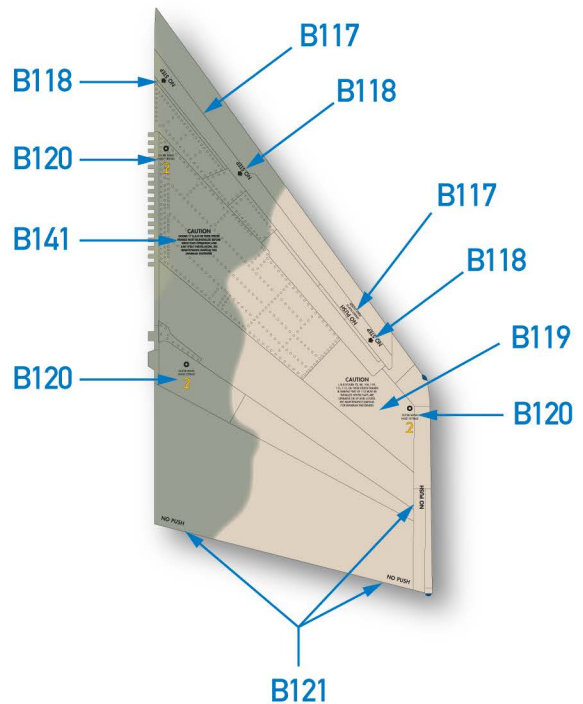
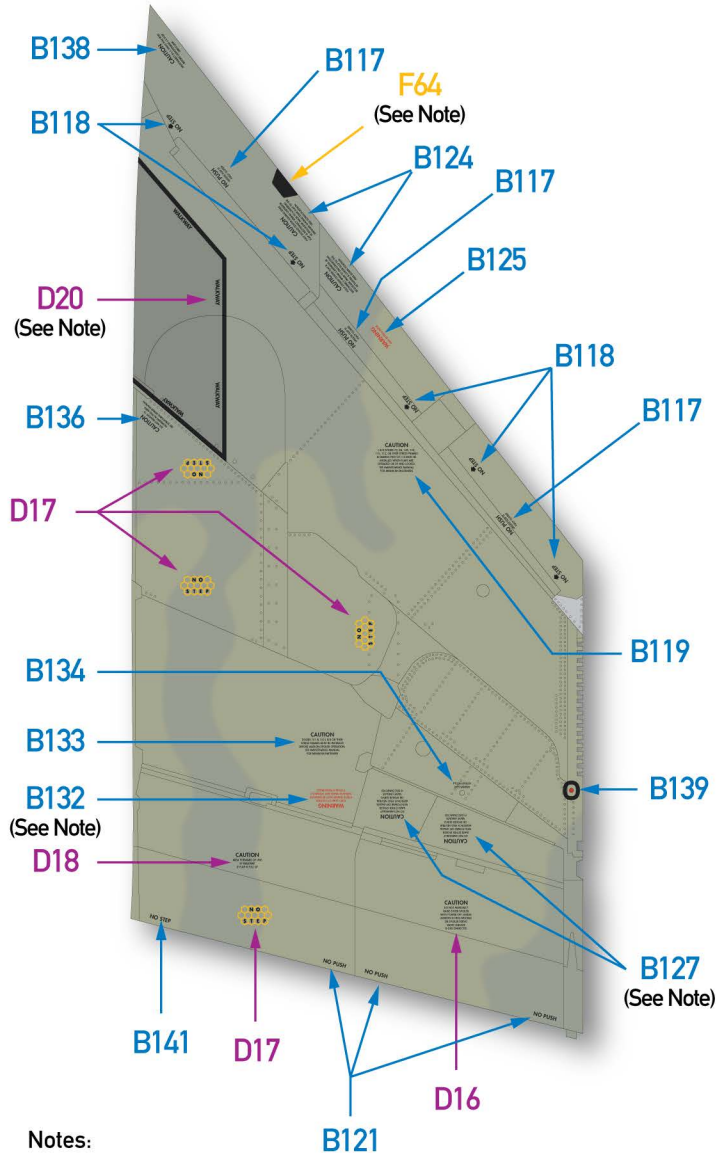

Notes:

B127/B132: Note the orientation of these items. Tops of letters face the trailing edge of the wing.

D19/D20: When applied at the factory, the area inside the walkway outline was finished with tinted Corogard paint. In the few photos we have where you can clearly see this area on a factory finished aircraft, the left hand (tan) Corogard area appears to be slightly lighter in tone than the surrounding camouflage color, while the right hand one (green) appears darker. Of course it quickly became dirty with grime and boot marks. We are not certain of the change over date to the later style (decals F96/F97), but we believe it was prior to serial number 71-0237 with the slatted wing. Check your references.

F63/F64: Note orientation of these items. Only found on hard wing F-4Es and F-4Js. Retained even after slats were retrofitted, though sometimes overpainted on F-4G conversions.

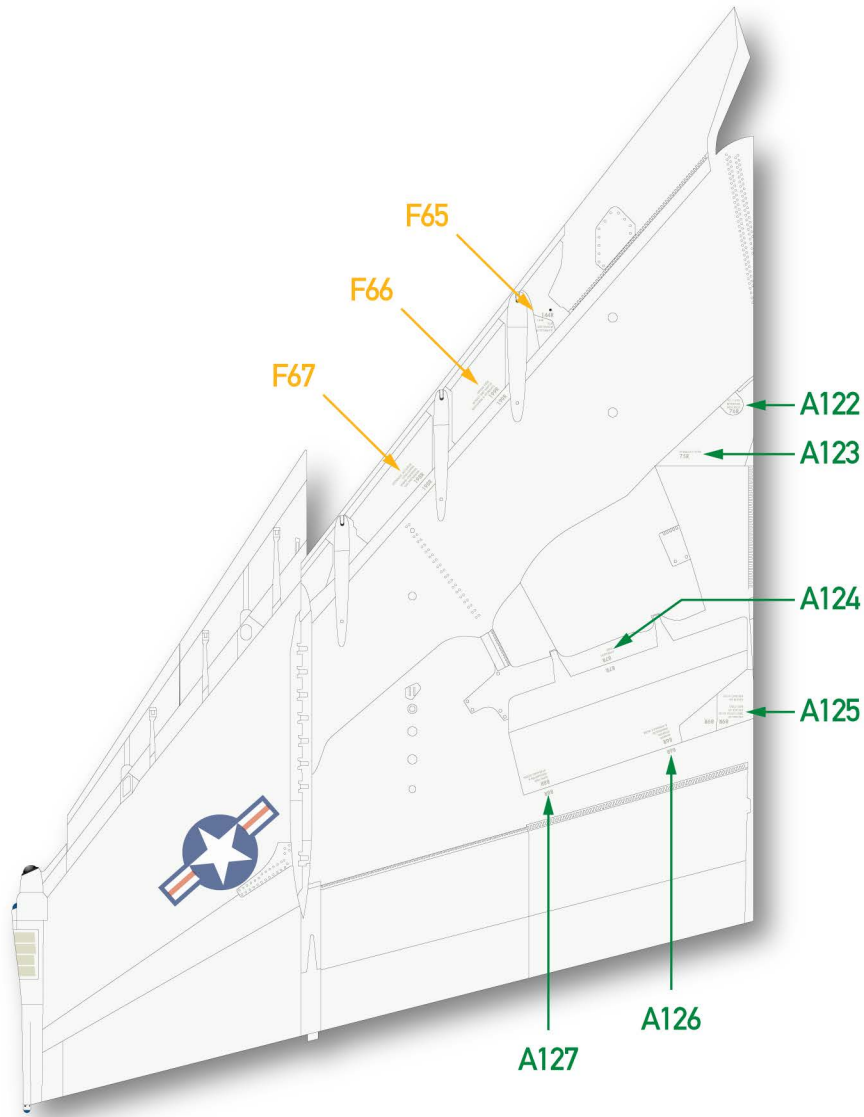

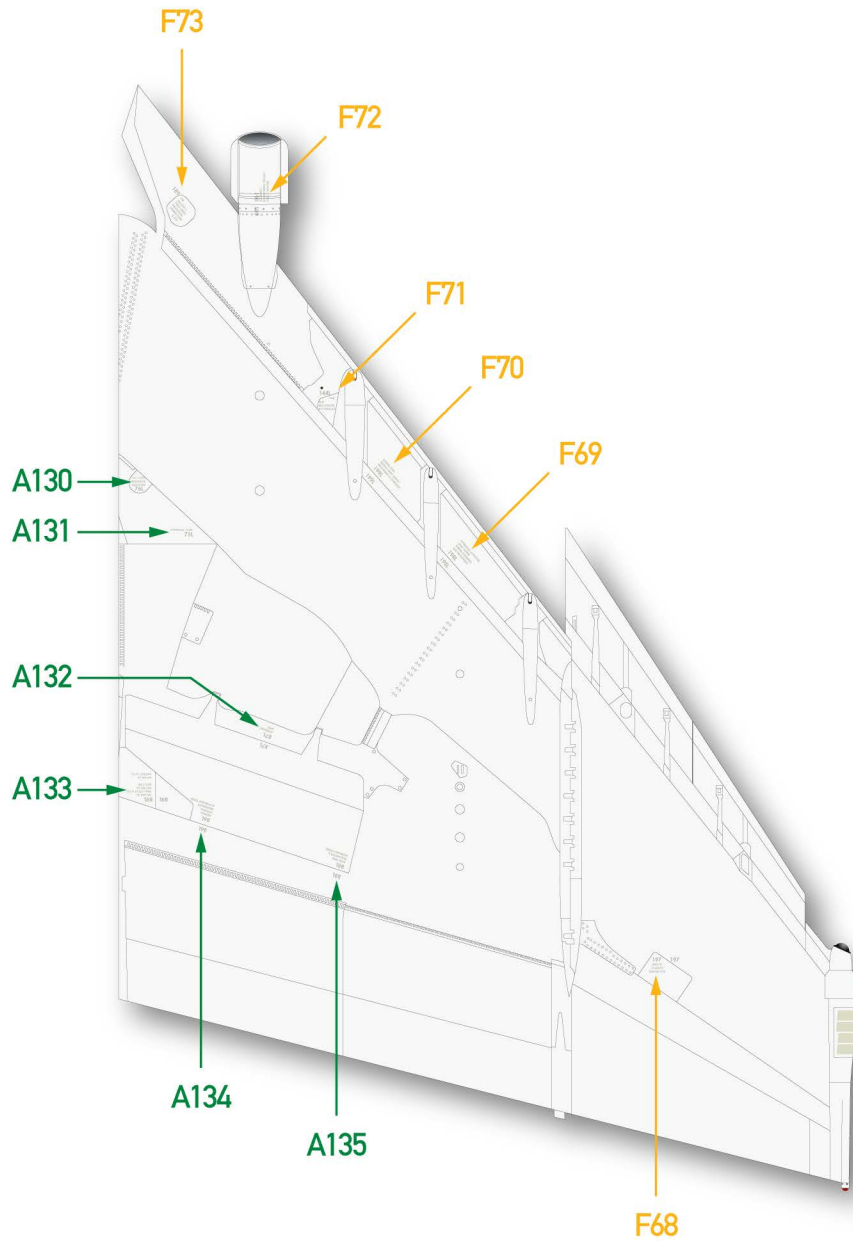

Note:

F75D: 71-0237 - 71-1796

F75E: 72-0121 & higher

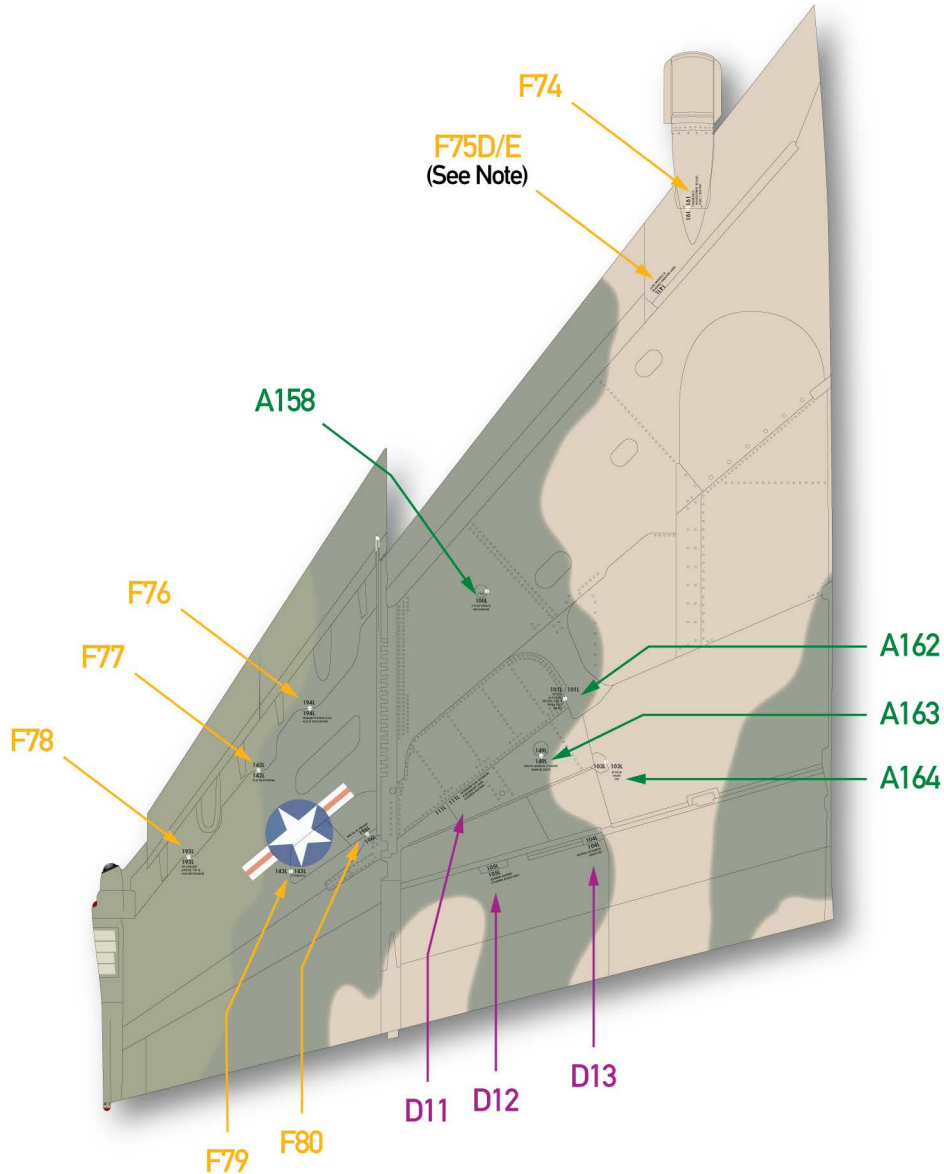

Note:

F86D: 71-0237 & higher

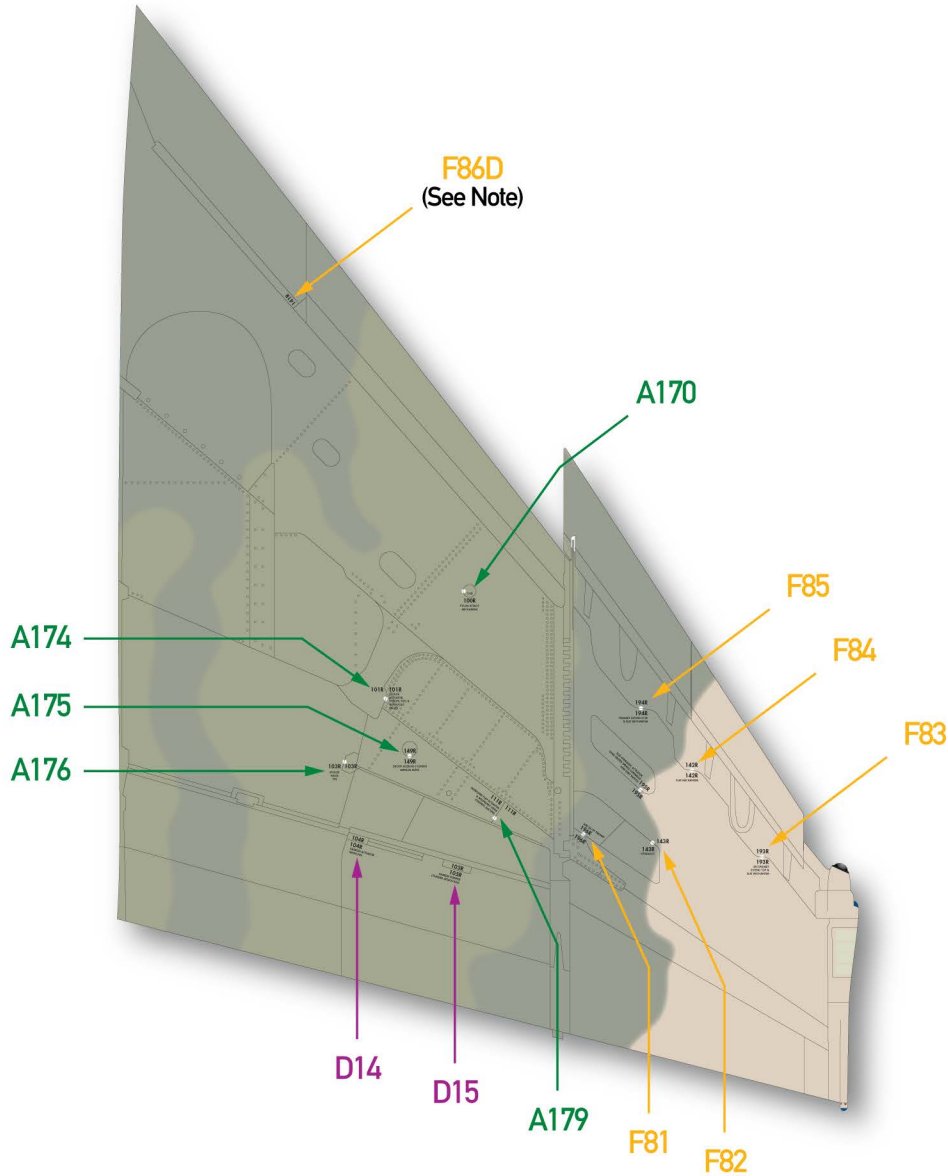

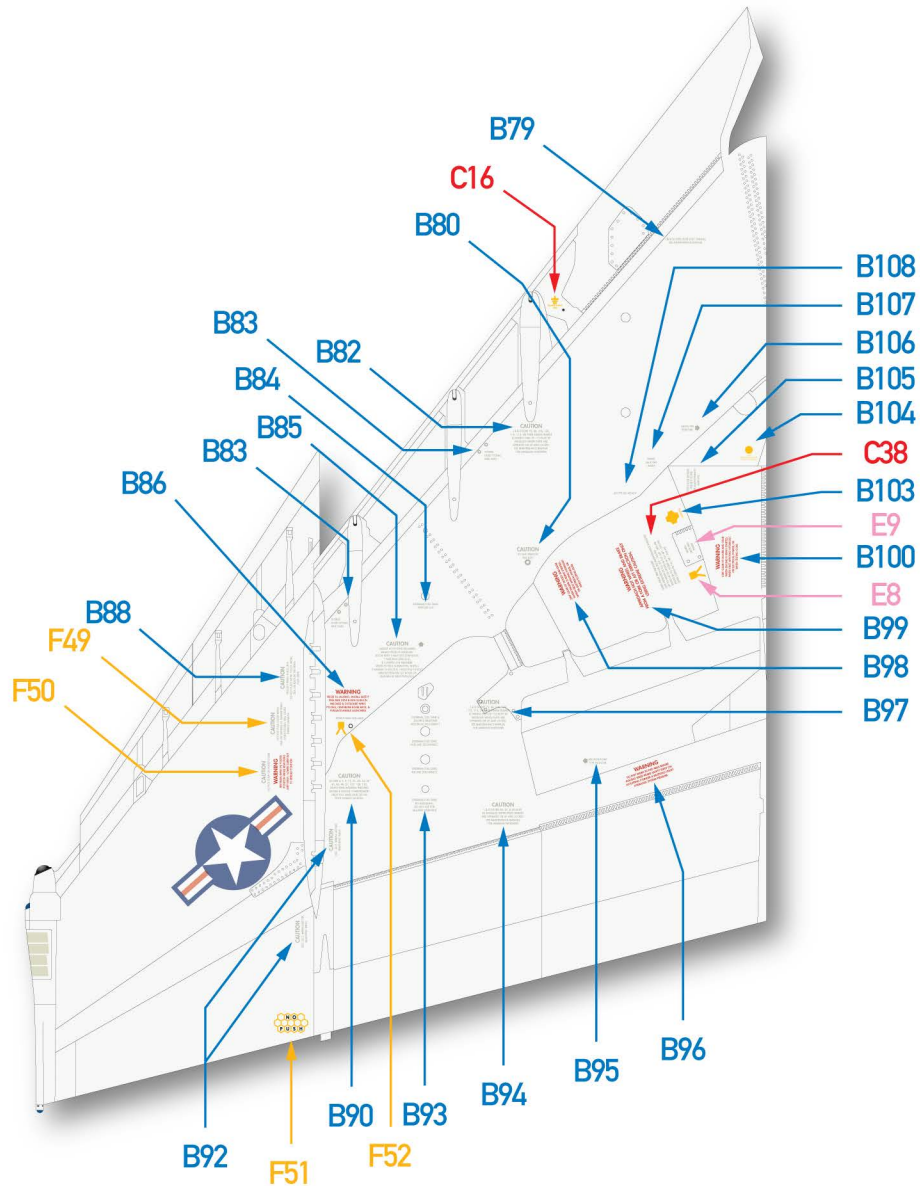

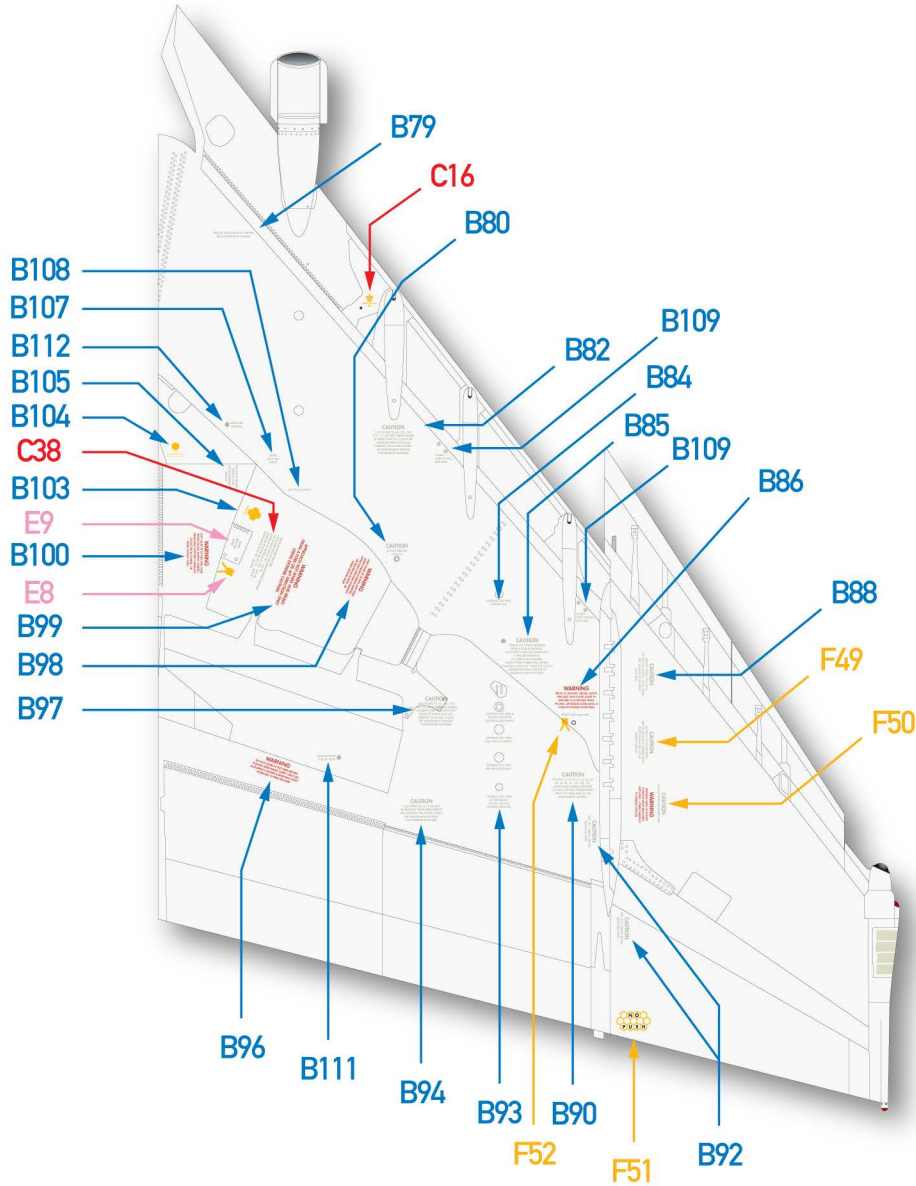

Outboard slat upper surface
(right side markings identical)

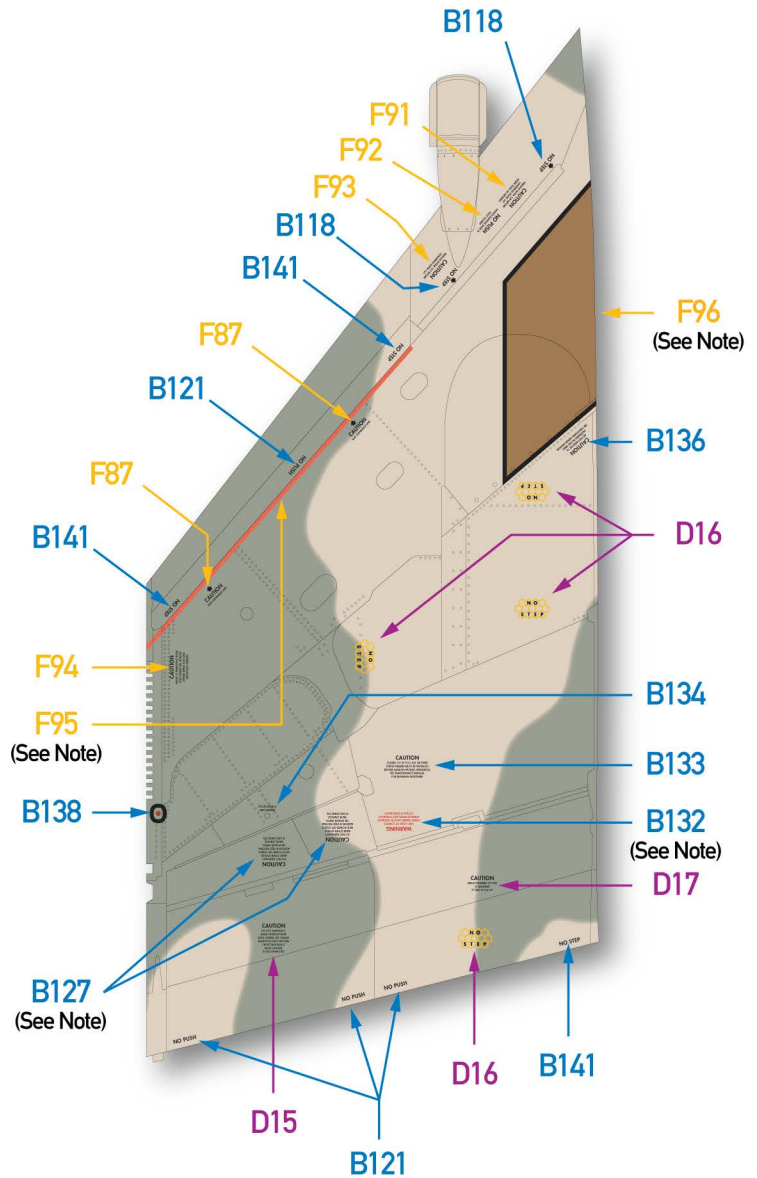
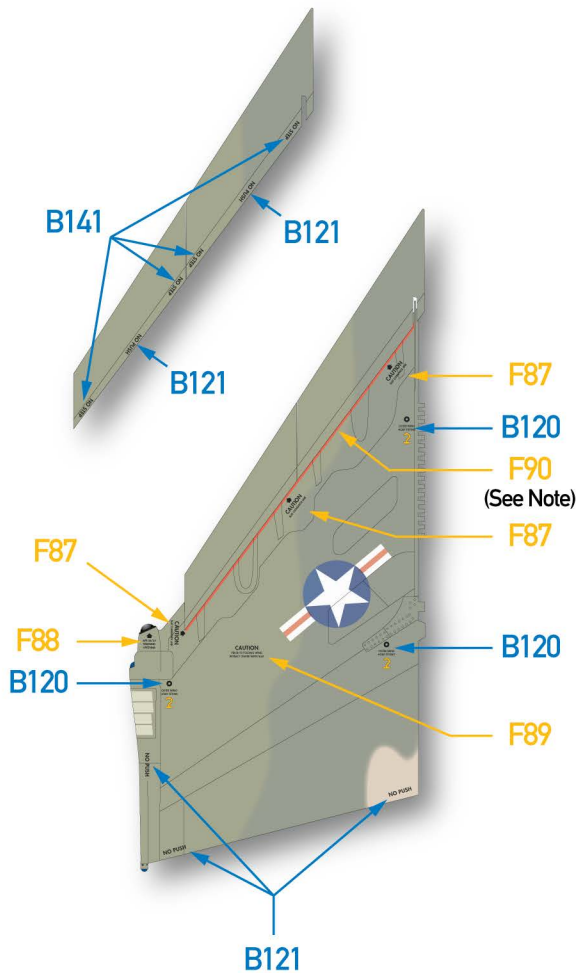

Notes:

B127/B132: Note the orientation of these items. Tops of letters face the trailing edge of the wing.

F90: Red warning line on upper wing surface is centered along aft edge of retracted slat such that only approximately 1/2 of its width is visible from directly above when the outboard slat is in the retracted position. Extra length is provided, trim as shown.

F95: The salmon and bright red versions seem to have been used interchangeably.

F96/F97: The trapezoidal walkway on the wing root is difficult or impossible to see in most photos. We have definitive proof of a brown version. We believe it is intended to be FS 30219, but it is noticeably different from the camouflage color, probably due to the different type and application method of the paint. We believe there was also a dark grey version, but we have not been able to pin down when or why it was used. The brown (and possibly grey) version seems to have come into use in the early to mid-1970s, possibly with the FY72 production blocks (F-4E-50-MC, 72-0121), but nothing firm on this has been uncovered to date. We have photos clearly showing these markings with no "WALKWAY" wording, but we have provided it separately in case you find photos showing it applied. See decals D19/D20 for positioning.

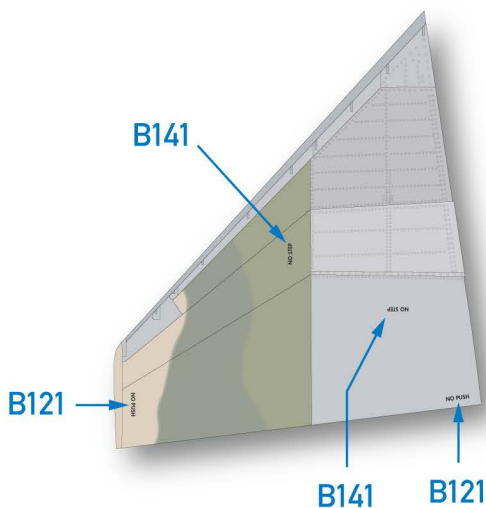

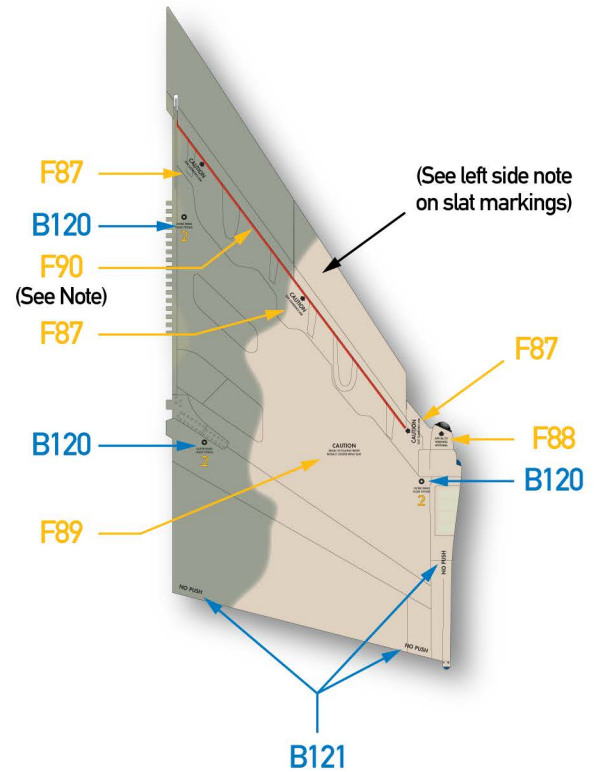
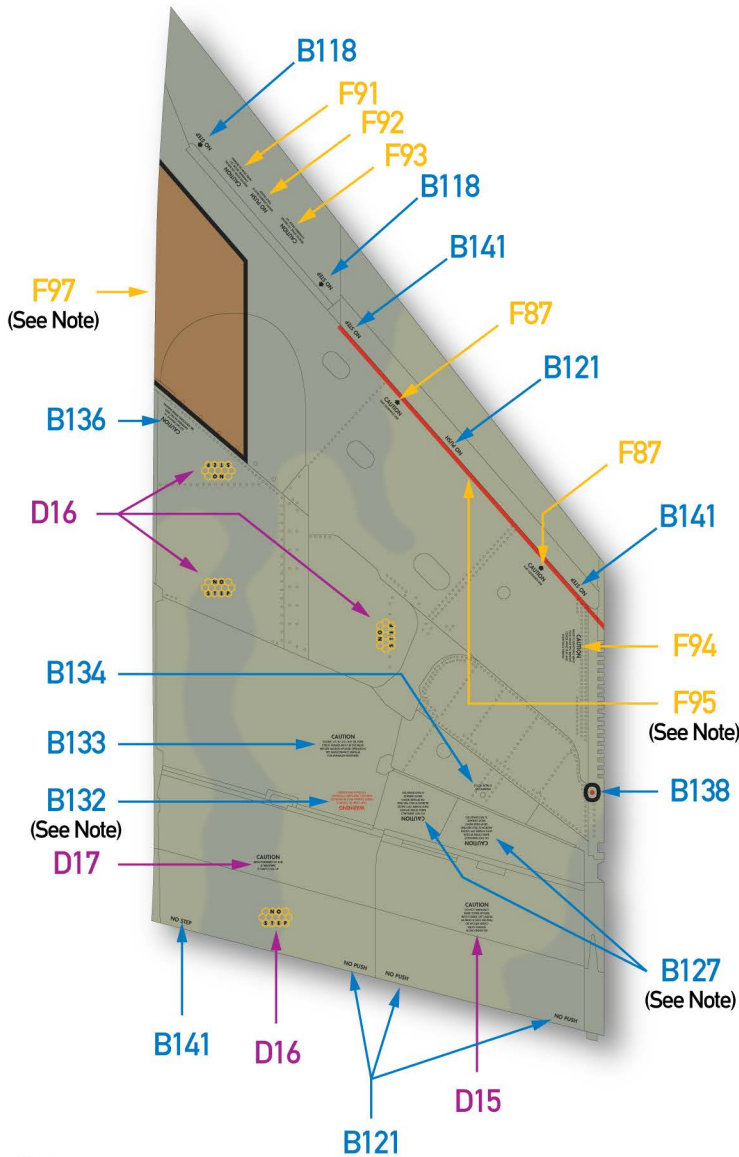

Notes:

B127/B132: Note the orientation of these items. Tops of letters face the trailing edge of the wing.

F90: Red warning line on upper wing surface is centered along aft edge of retracted slat such that only approximately 1/2 of its width is visible from directly above when the outboard slat is in the retracted position. Extra length is provided, trim as shown.

F95: The salmon and bright red versions seem to have been used interchangeably.

F96/F97: The trapezoidal walkway on the wing root is difficult or impossible to see in most photos. We have definitive proof of a brown version. We believe it is intended to be FS 30219, but it is noticeably different from the camouflage color, probably due to the different type and application method of the paint. We believe there was also a dark grey version, but we have not been able to pin down when or why it was used. The brown (and possibly grey) version seems to have come into use in the early to mid-1970s, possibly with the FY72 production blocks (F-4E-50-MC, 72-0121), but nothing firm on this has been uncovered to date. We have photos clearly showing these markings with no "WALKWAY" wording, but we have provided it separately in case you find photos showing it applied. See decals D19/D20 for positioning.

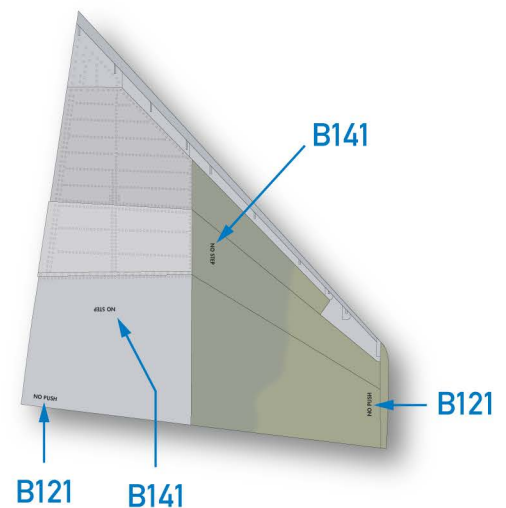

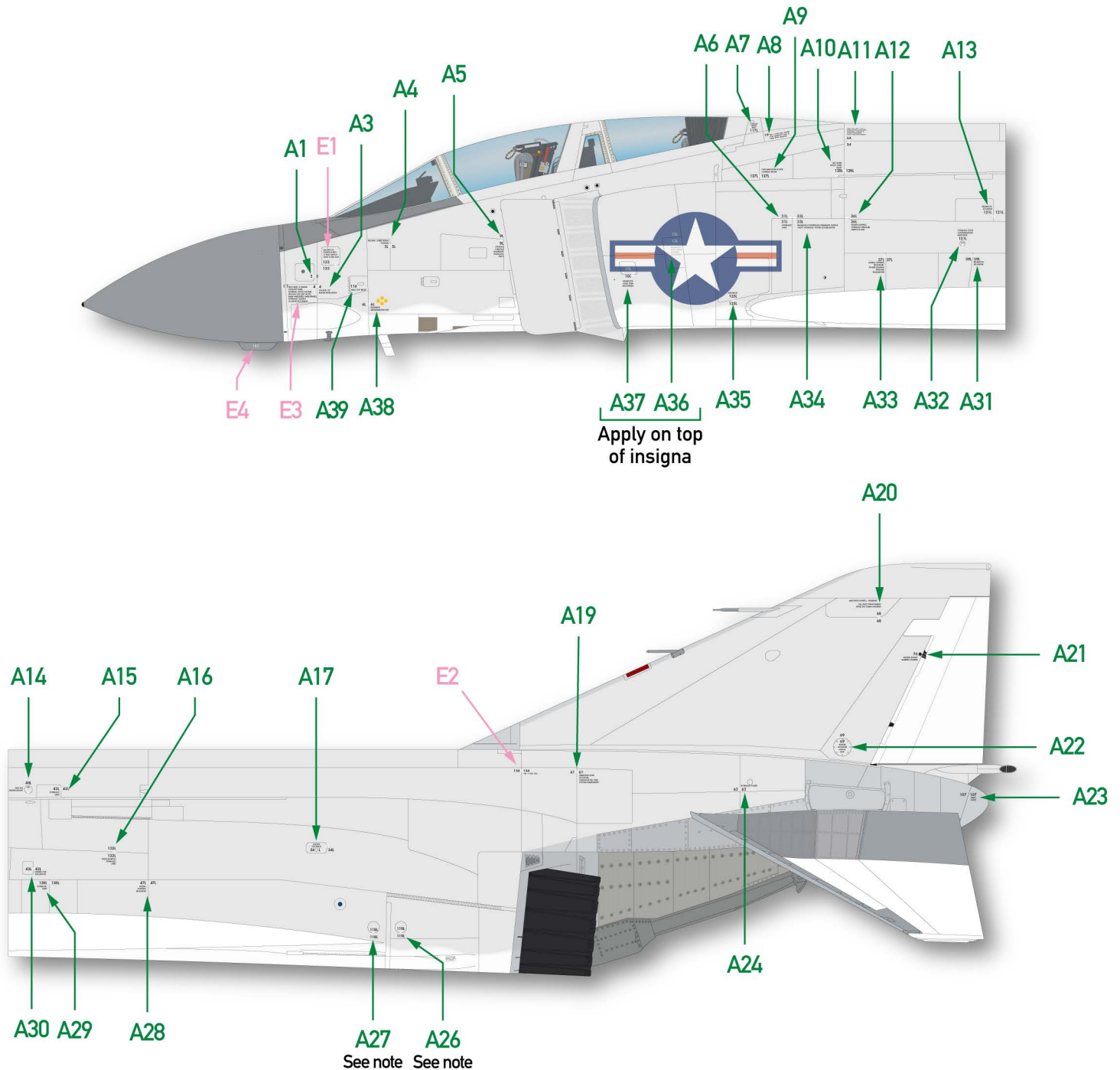

Note: Decals A26 and A27 may be positioned at the top or the bottom of the round access panels, depending on whether the taller "NAVY" or shorter "MARINES" titles were applied. Most F-4Bs, even those that were delivered directly to USMC units, left the factory with "NAVY" applied, with these items positioned as shown.

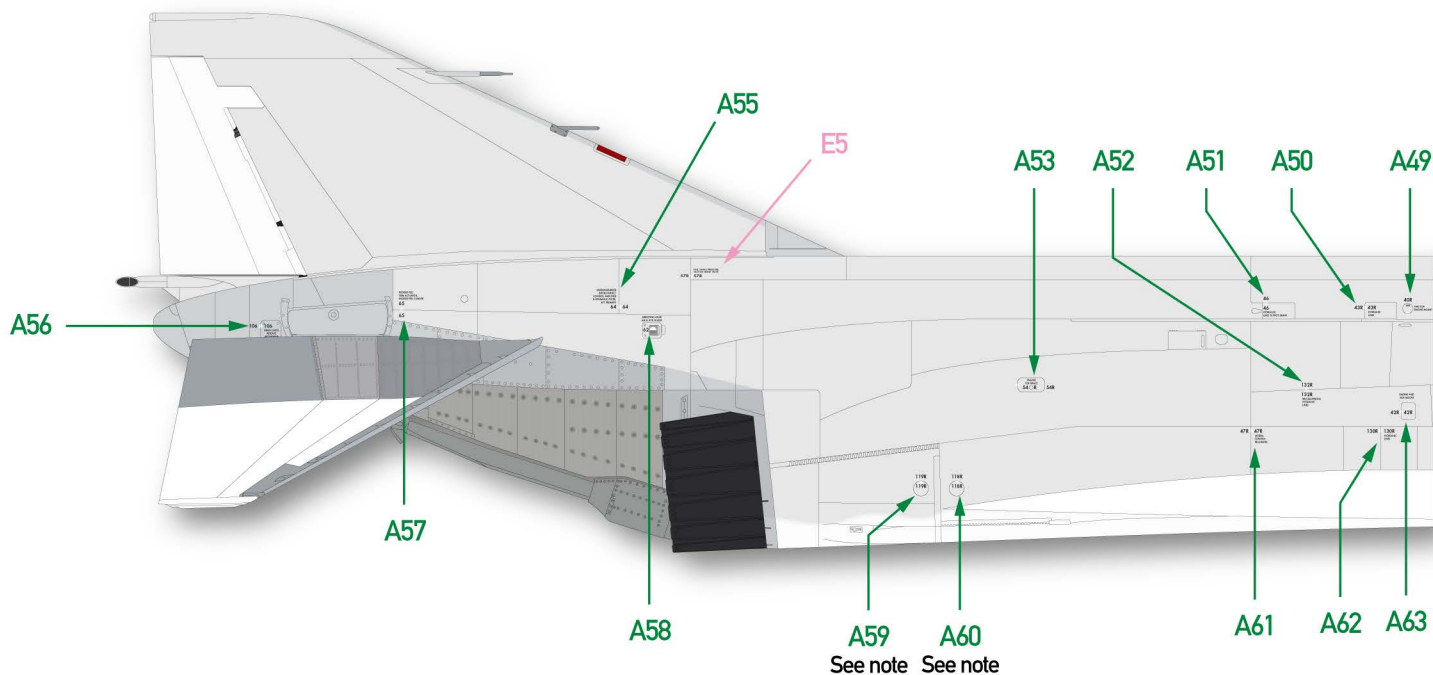
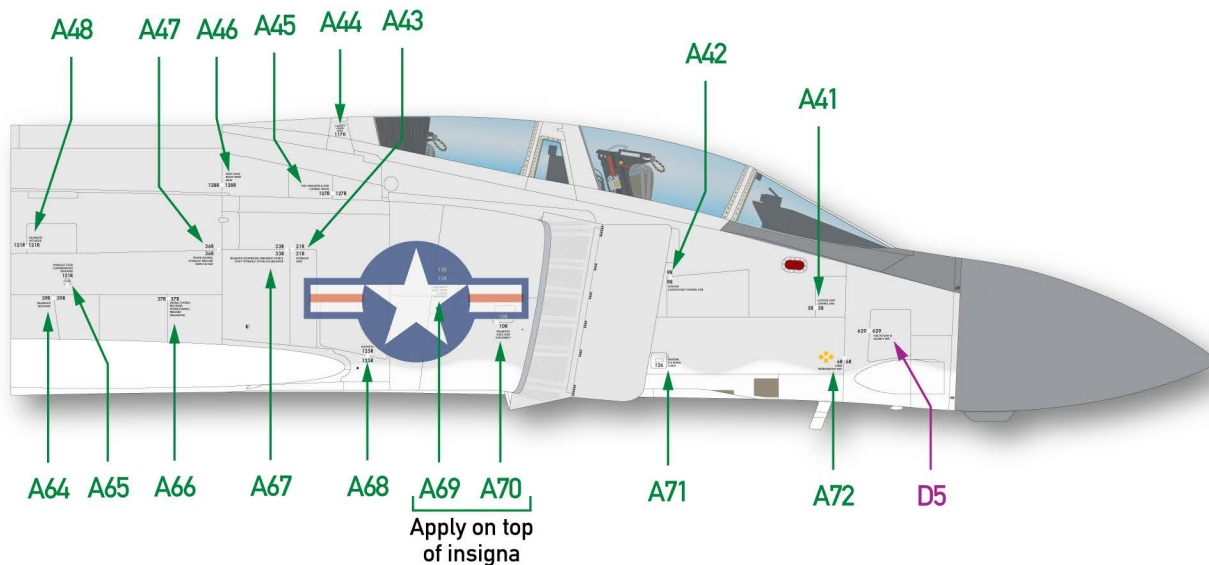

Note: Decals A59 and A60 may be positioned at the top or the bottom of the round access panels, depending on whether the taller "NAVY" or shorter "MARINES" titles were applied. Most F-4Bs, even those that were delivered directly to USMC units, left the factory with "NAVY" applied, with these items positioned as shown.

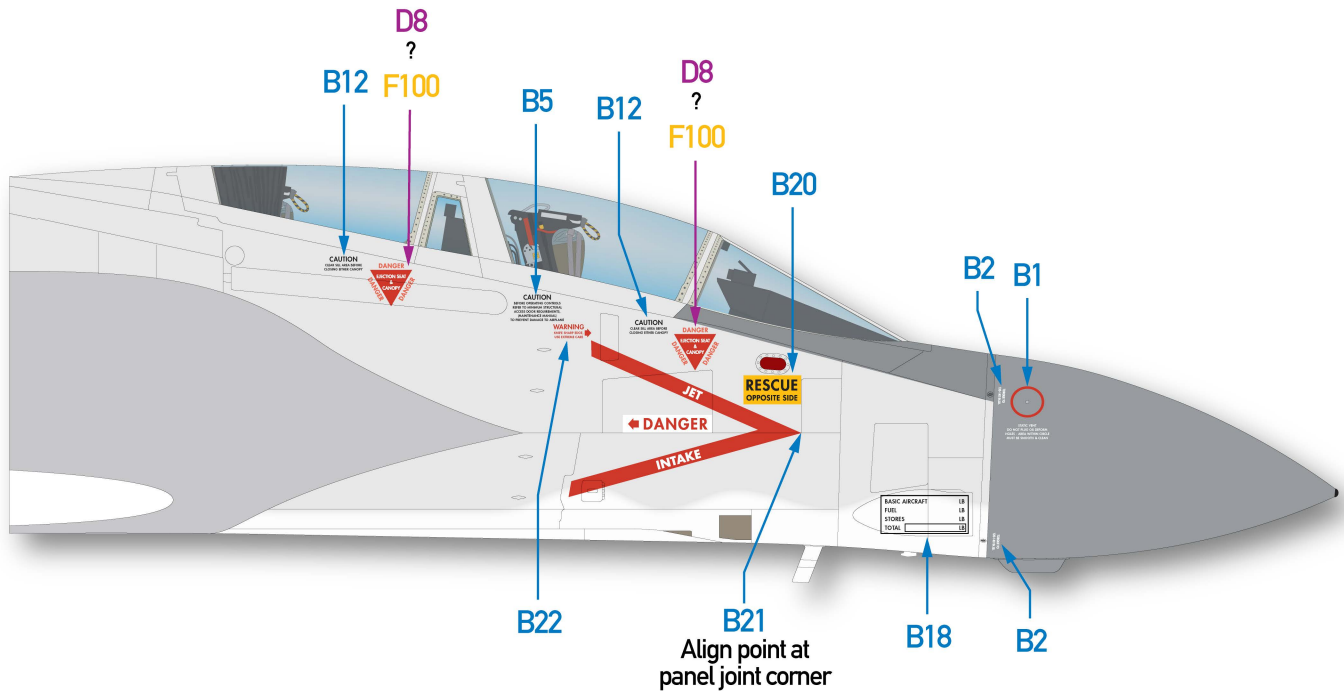
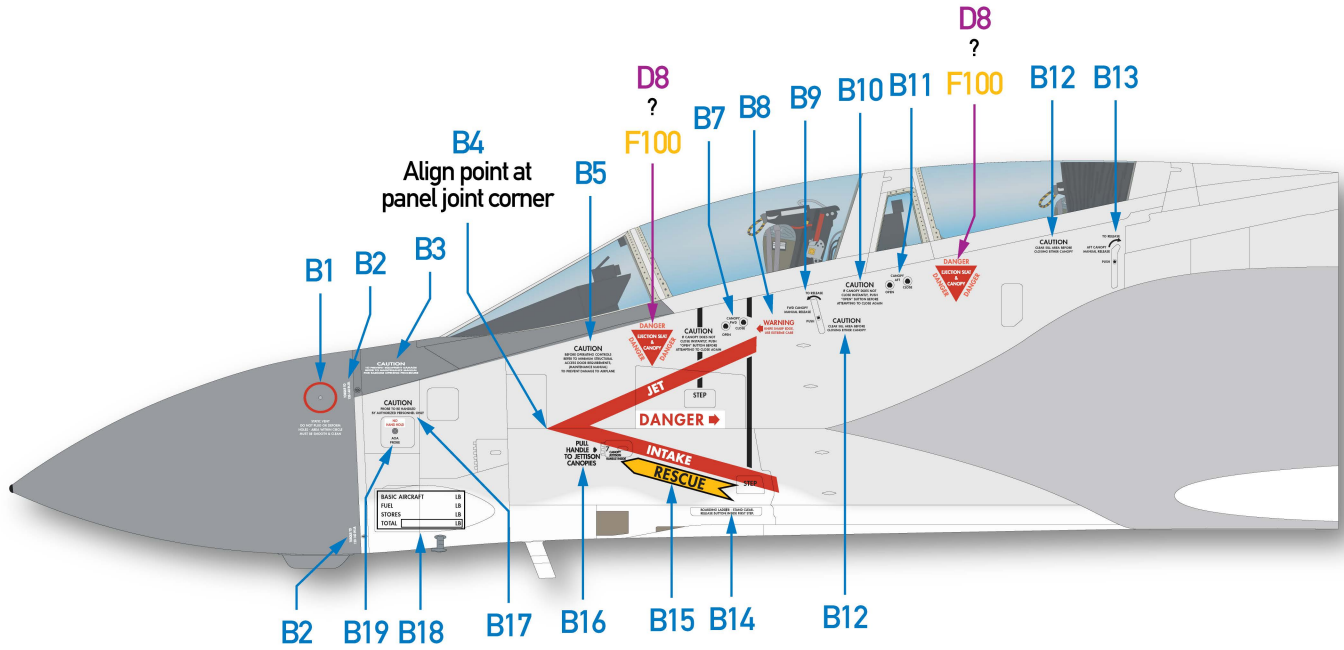

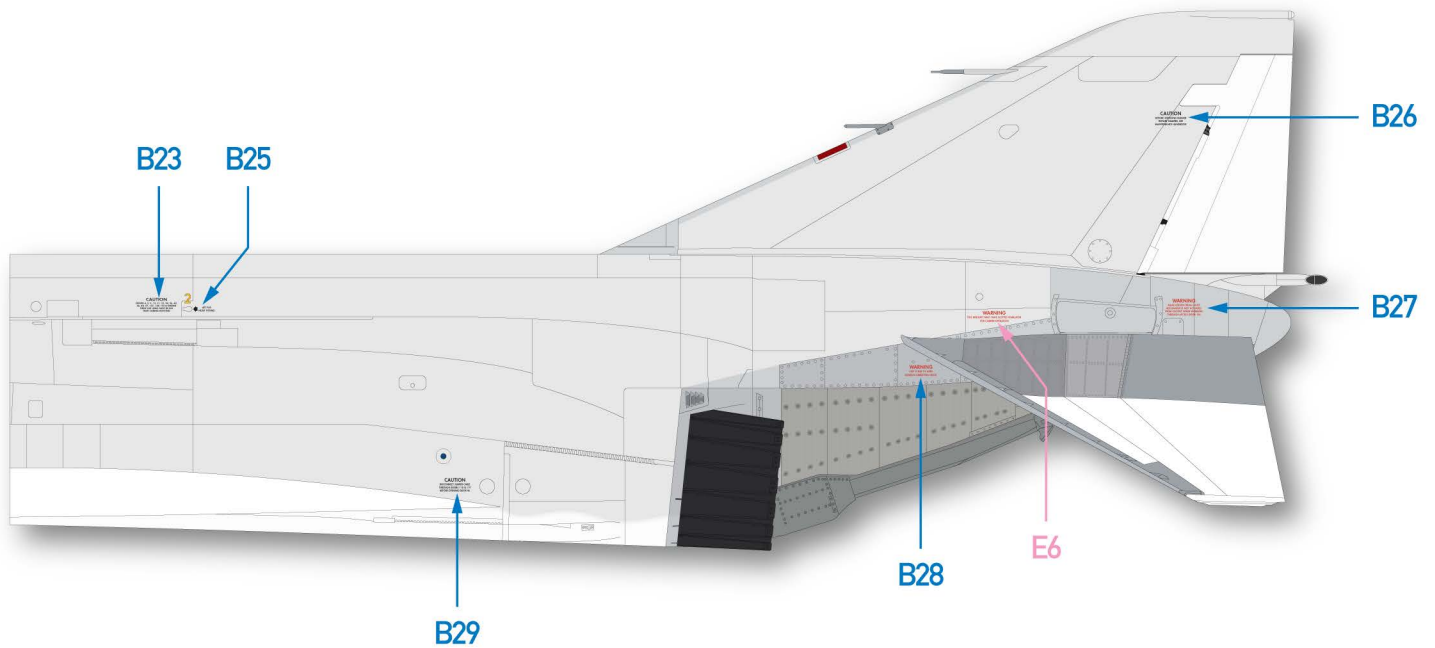
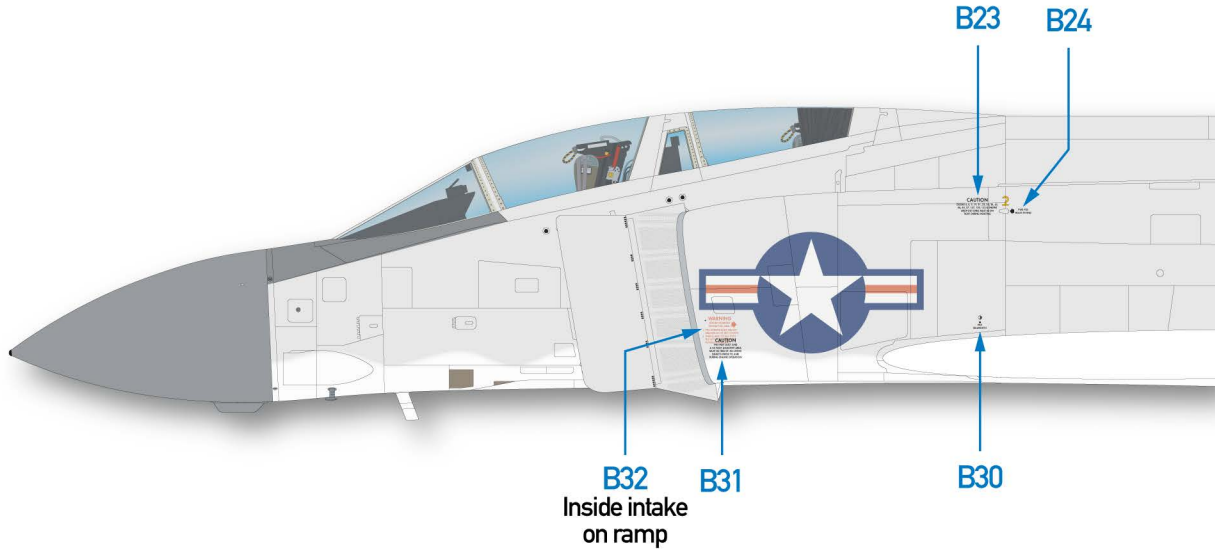

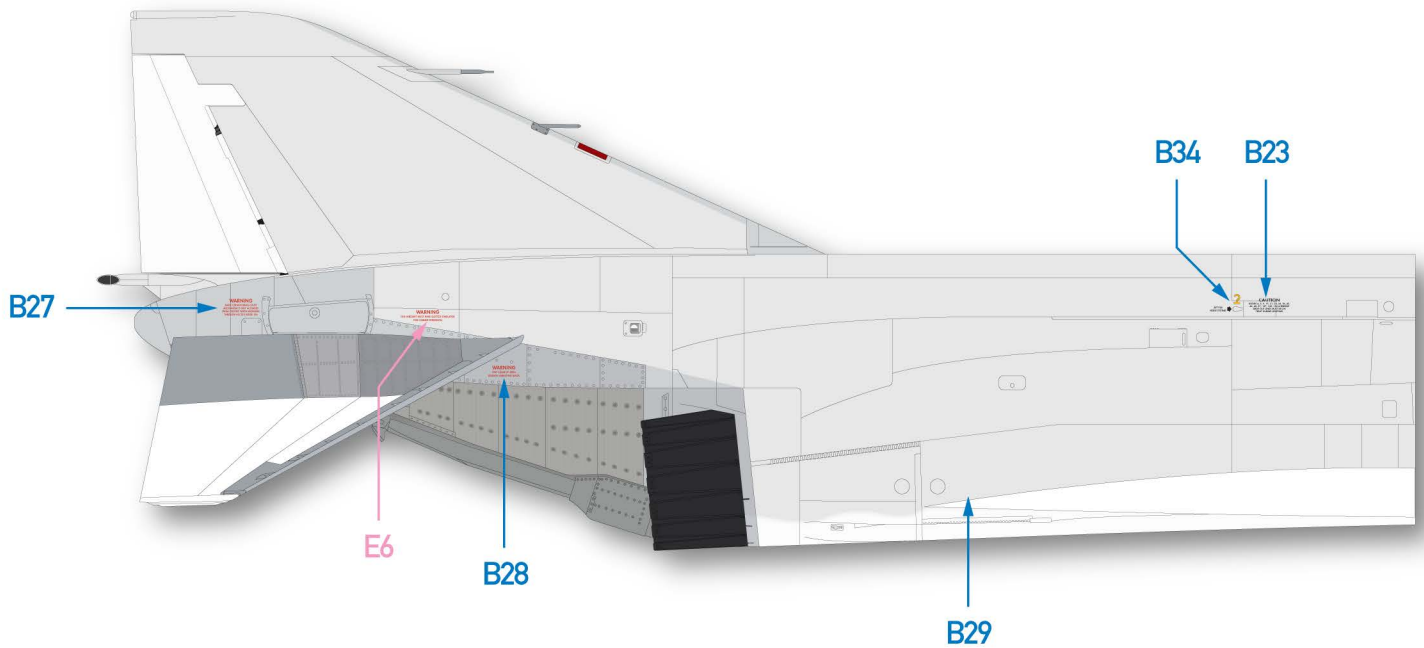
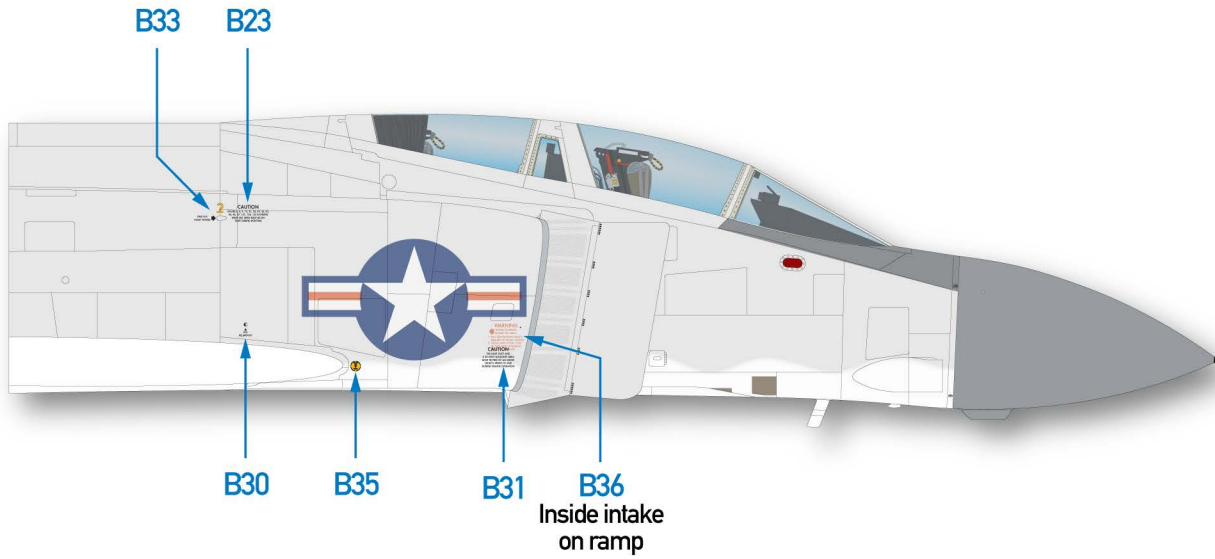

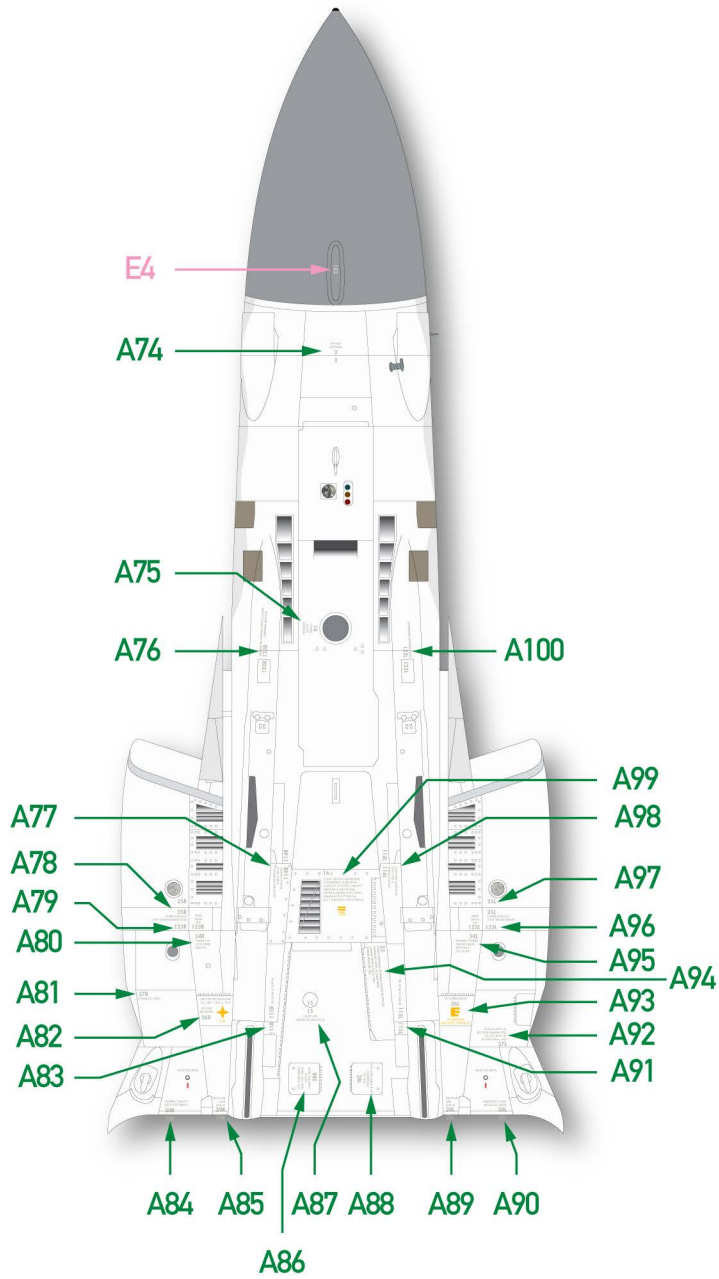

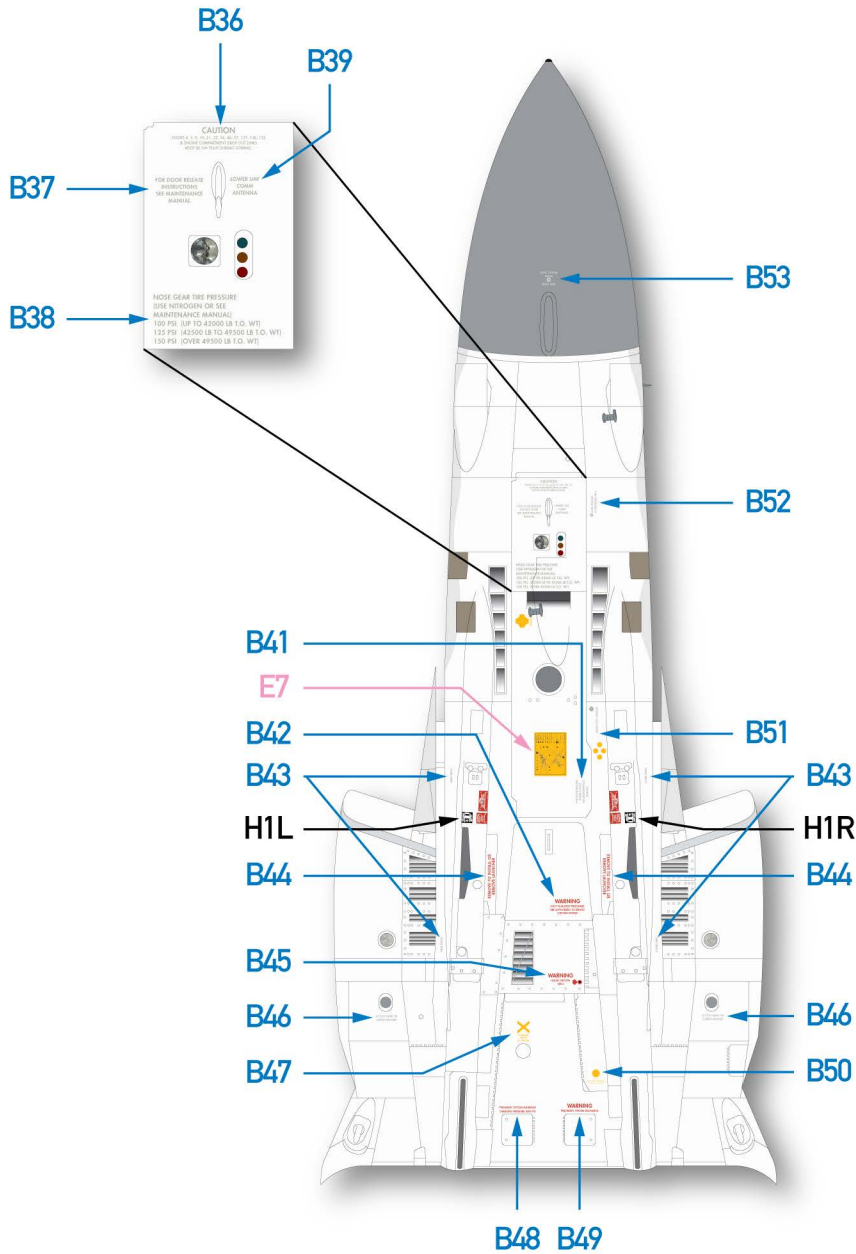

↑
Forward

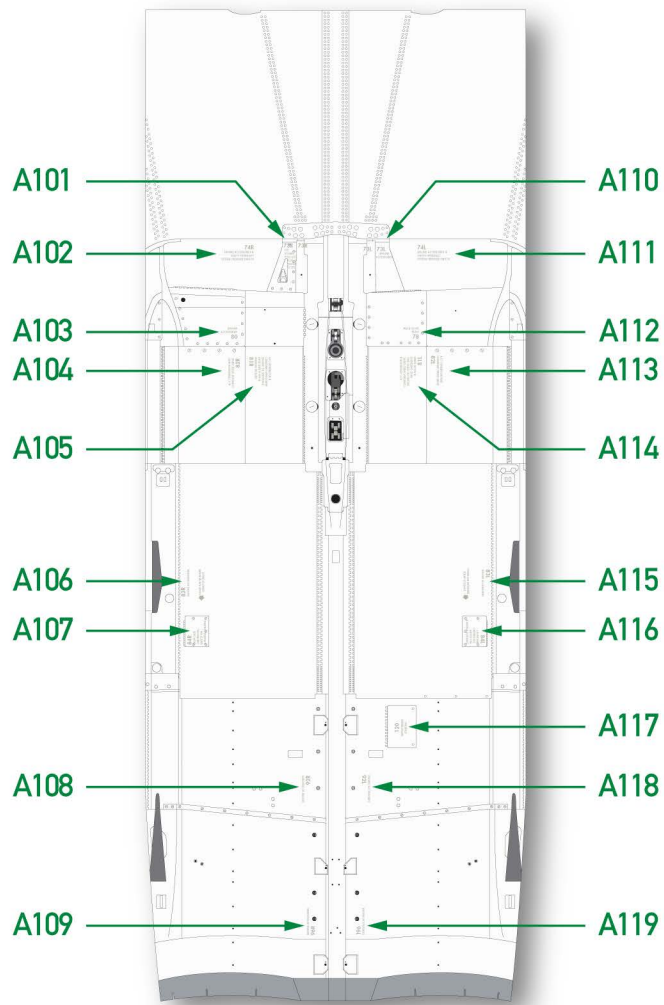

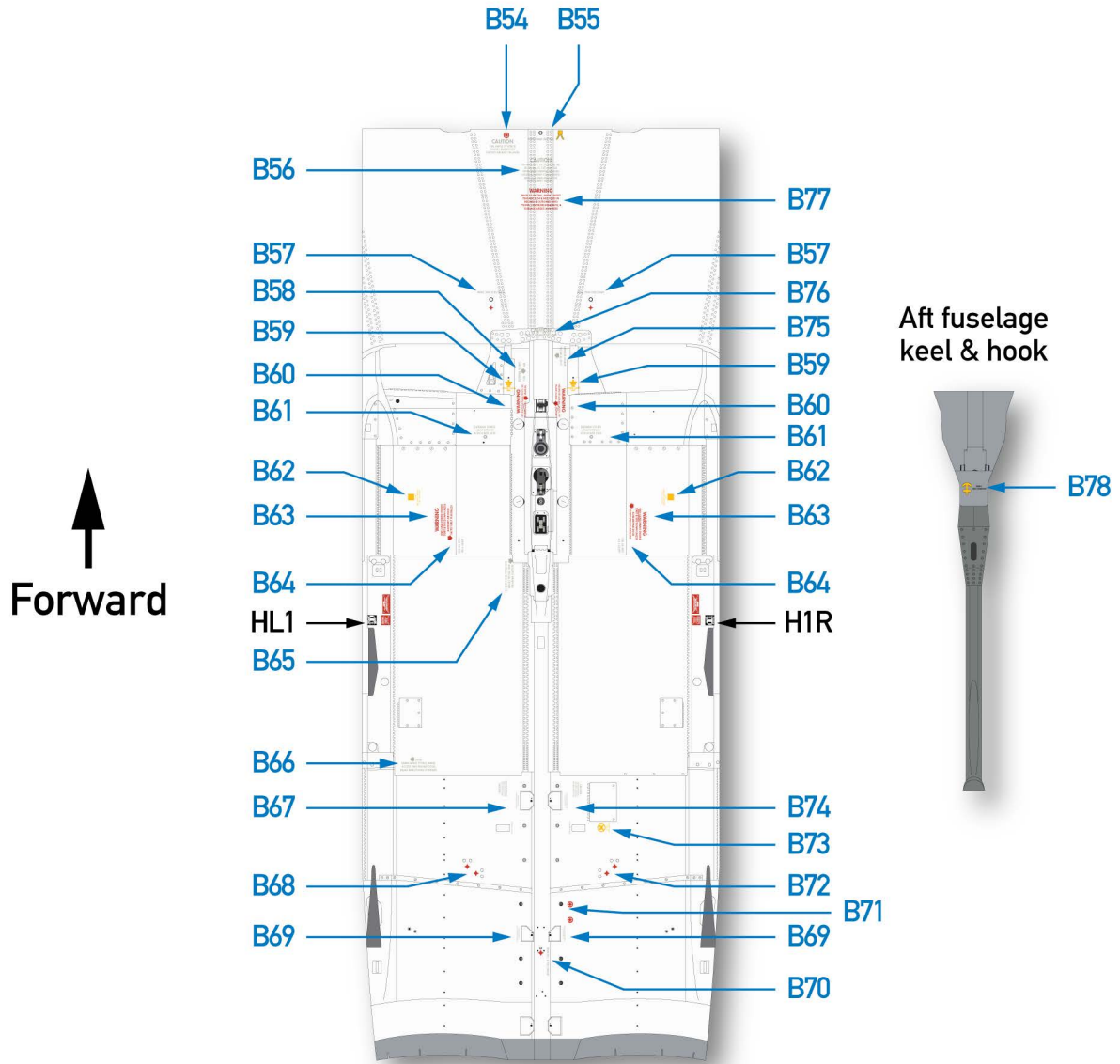

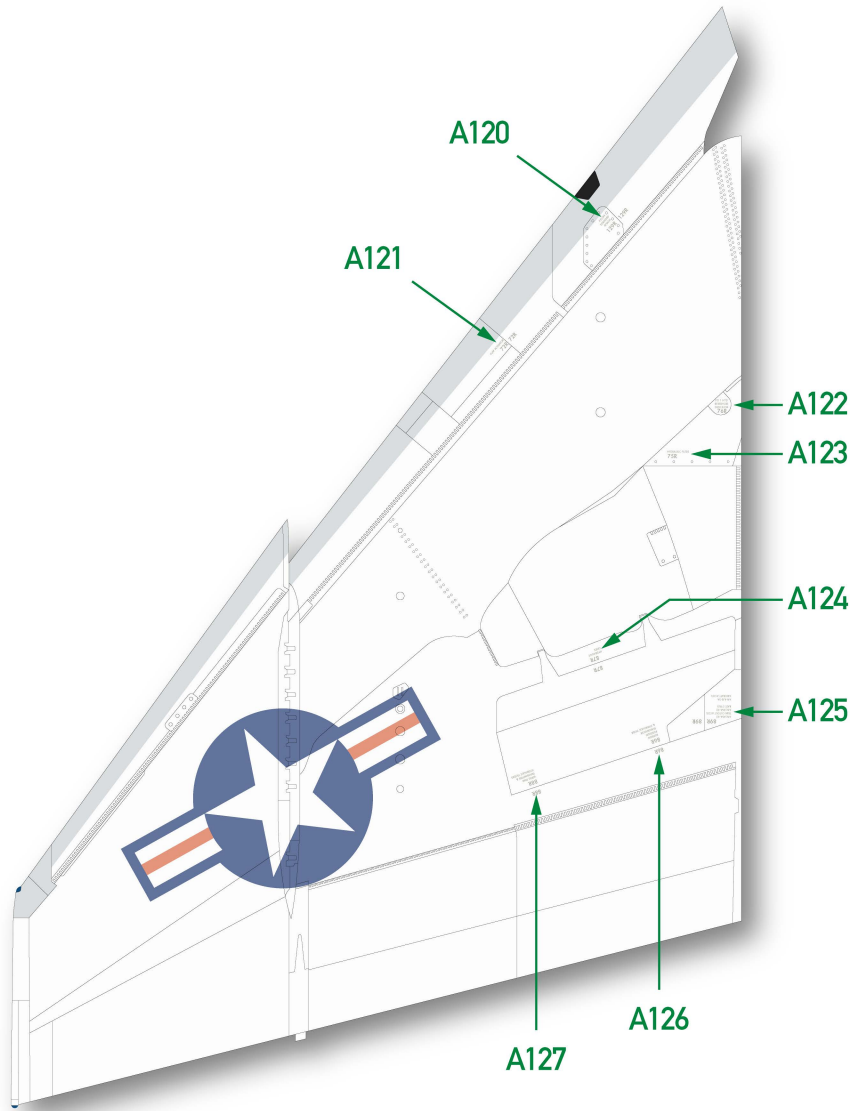

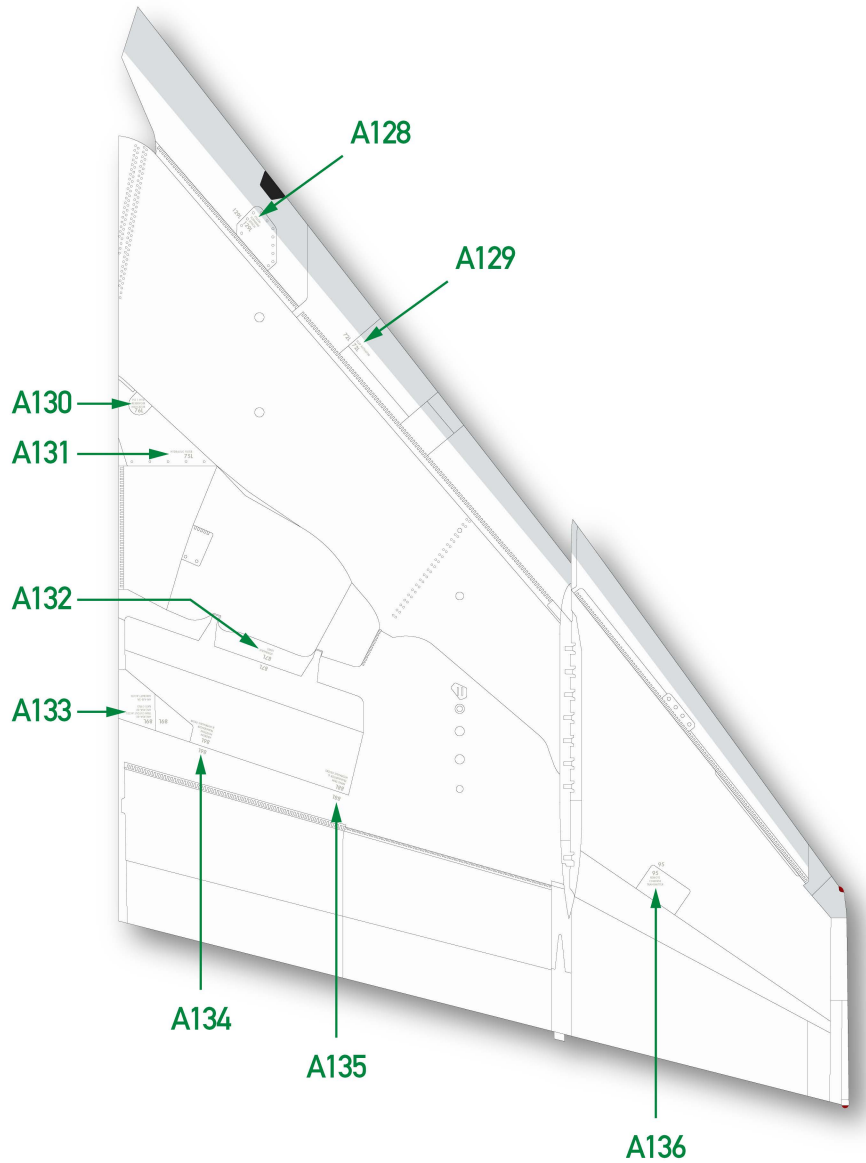

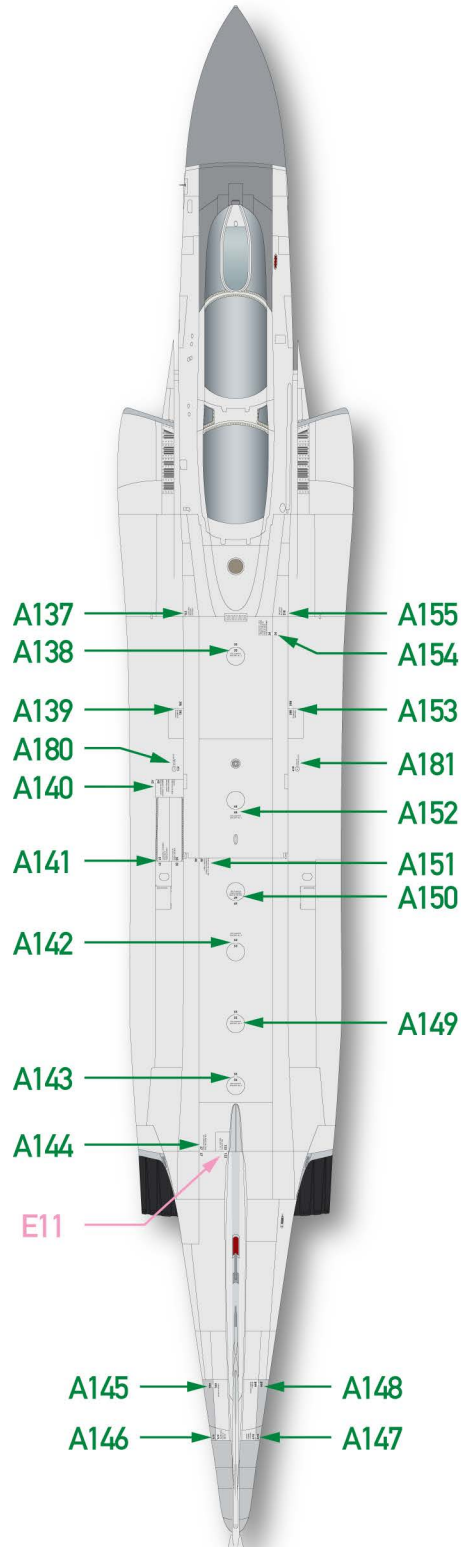

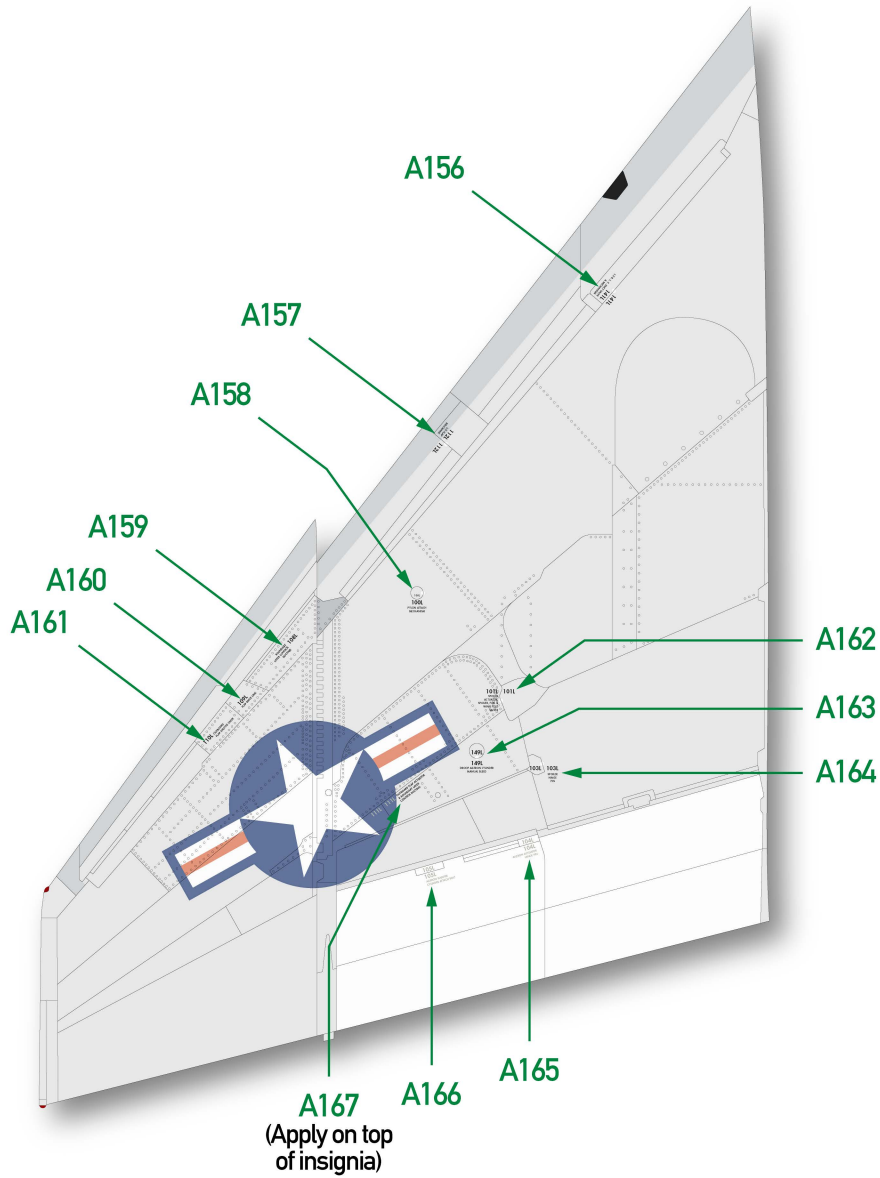

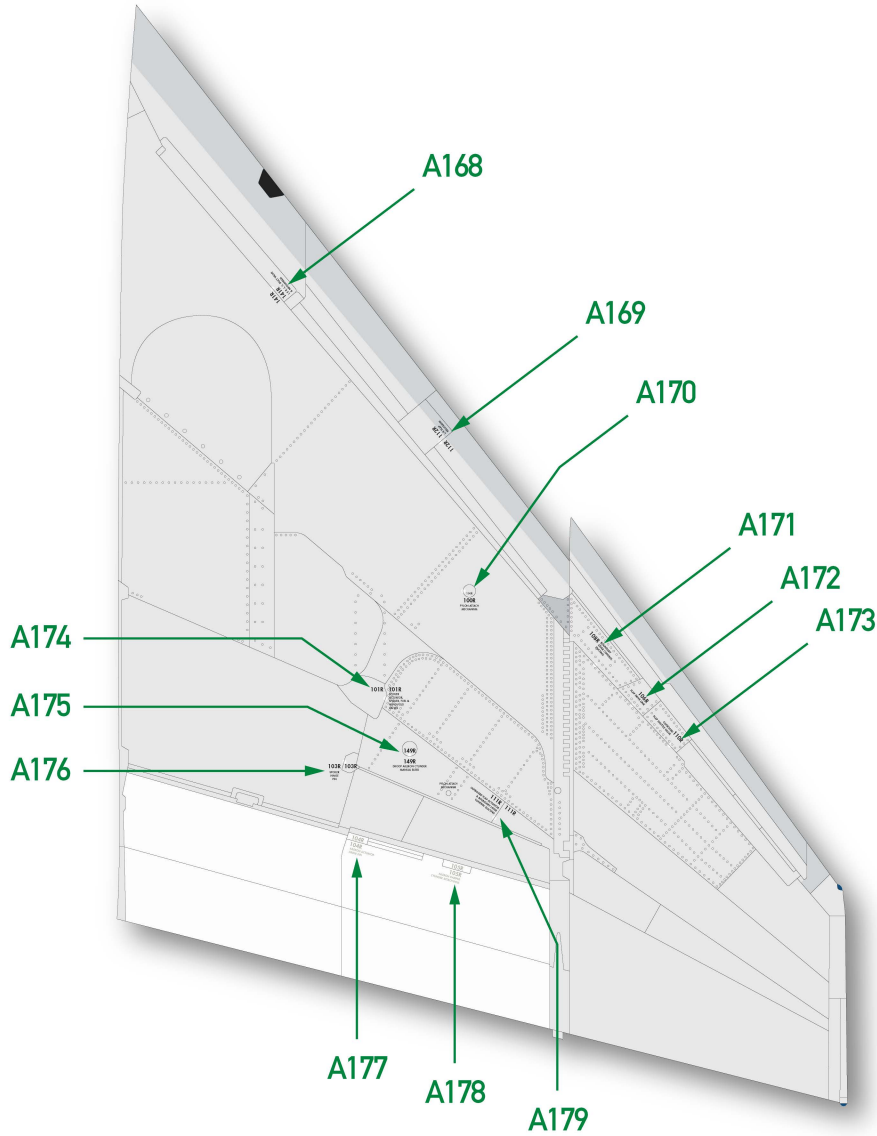

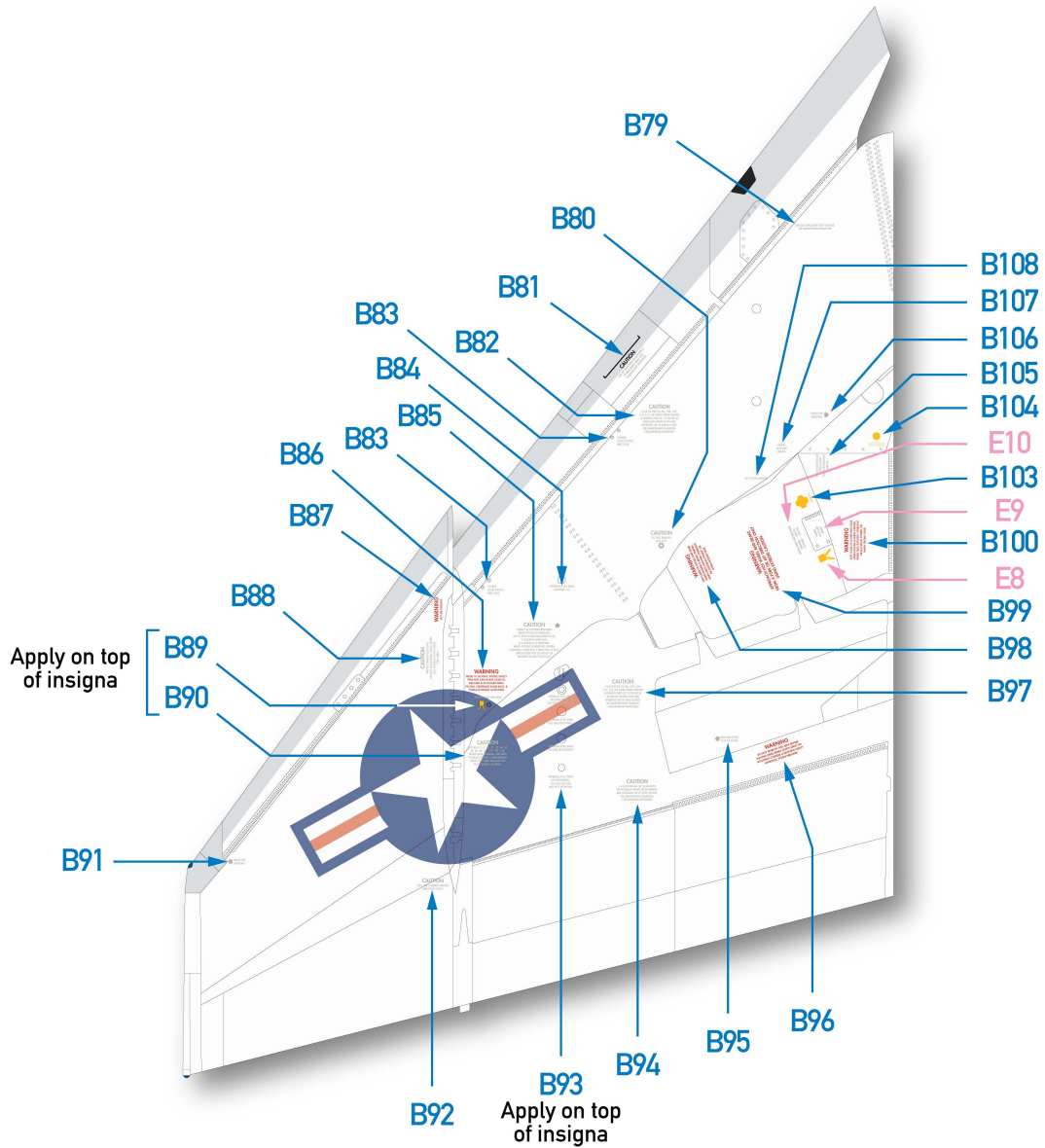

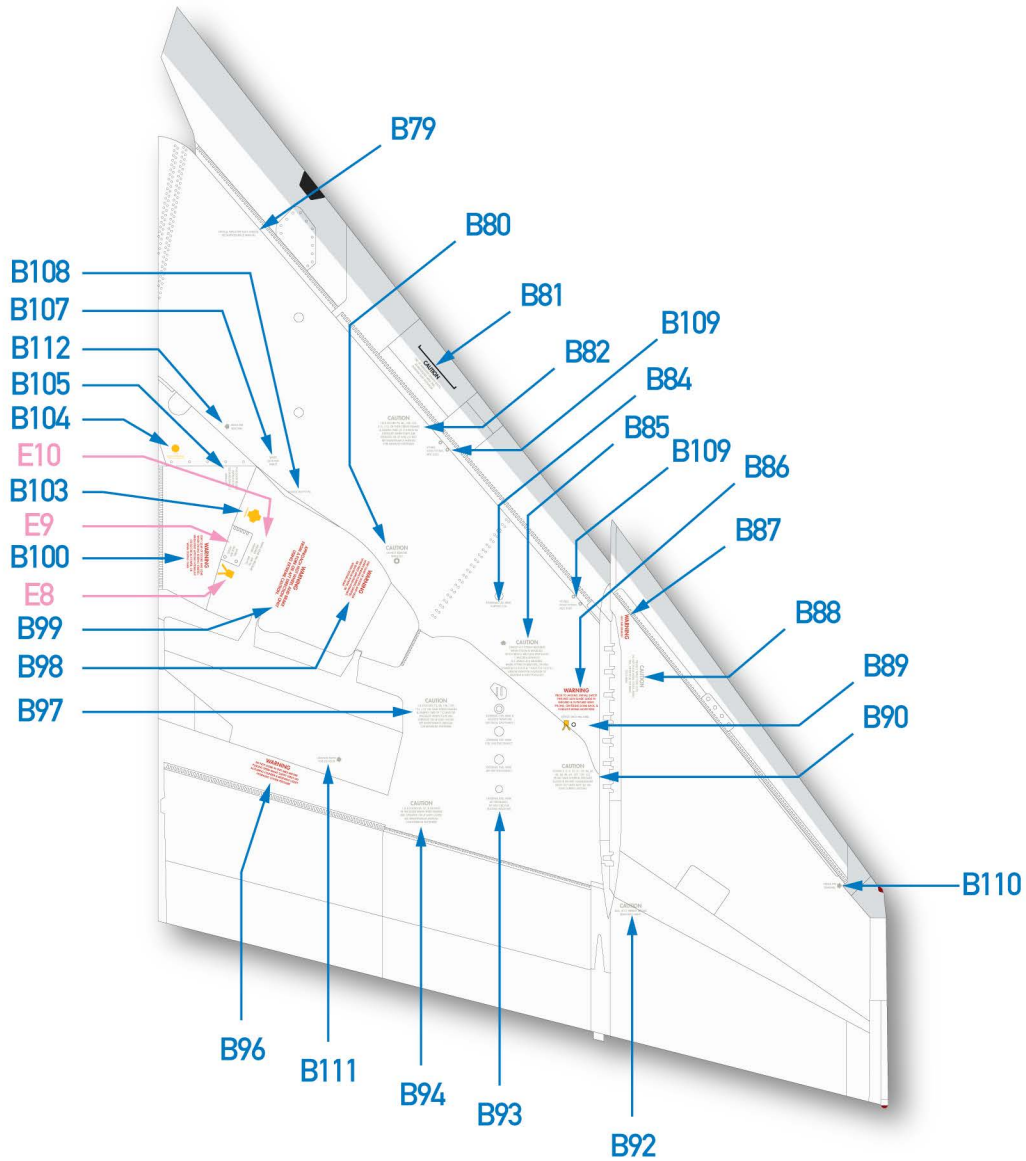

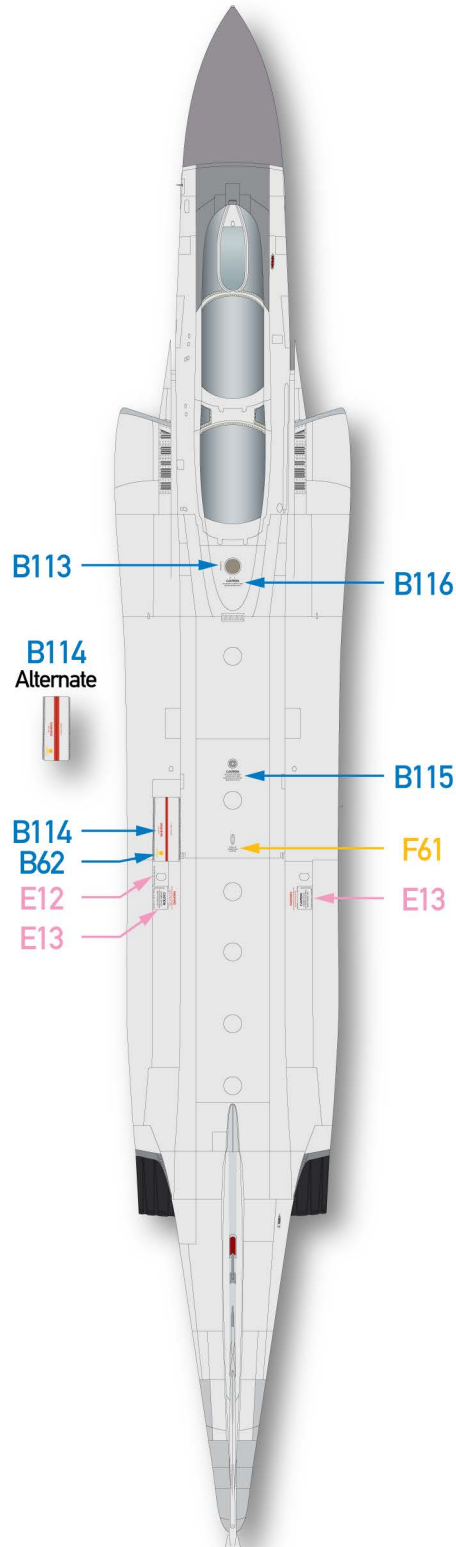

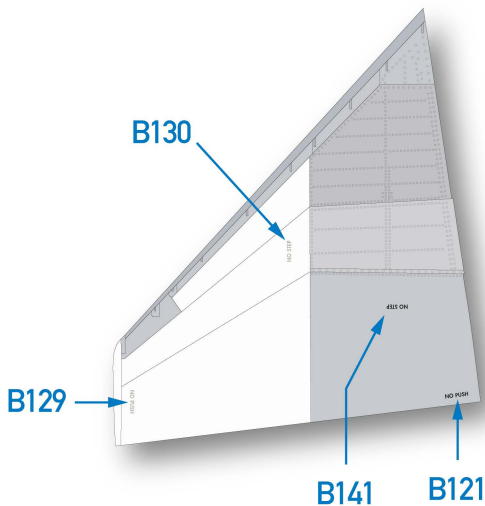
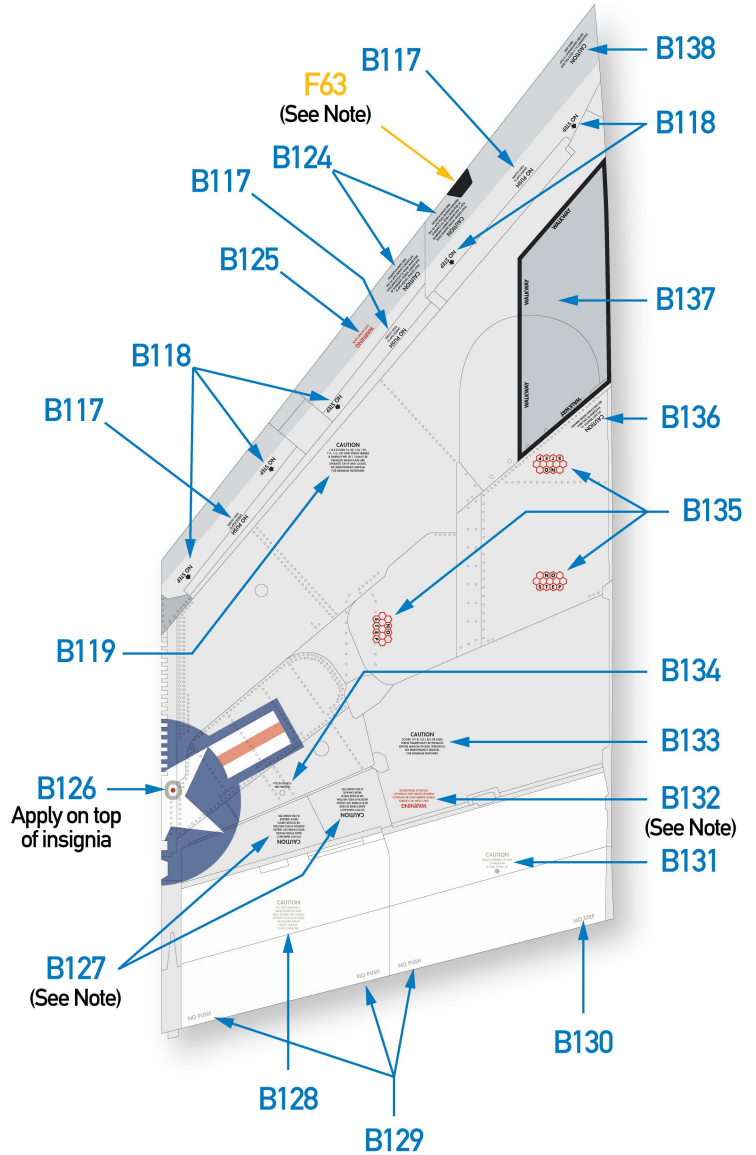
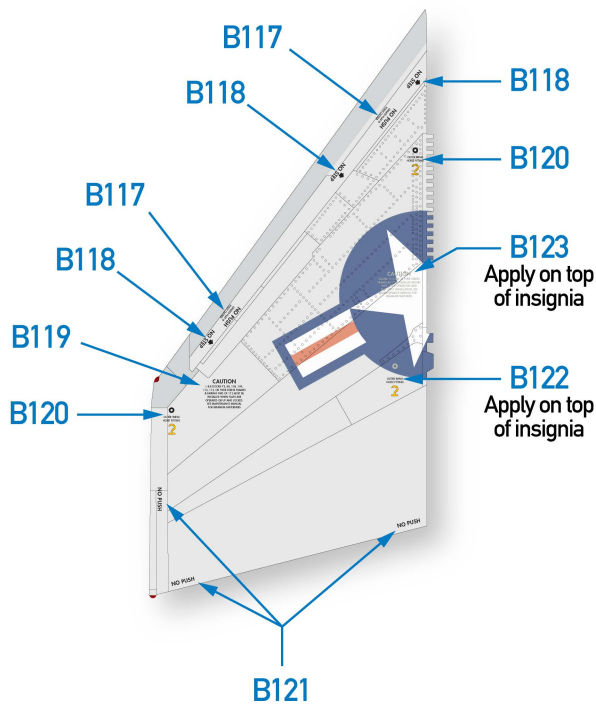

Note:

B127/B132: Note the orientation of these items. Tops of letters face the trailing edge of the wing.

F63/F64: Note orientation of these items. Only found on hard wing F-4Es and F-4Js. Retained even after slats were retrofitted, though sometimes overpainted on F-4S conversions.

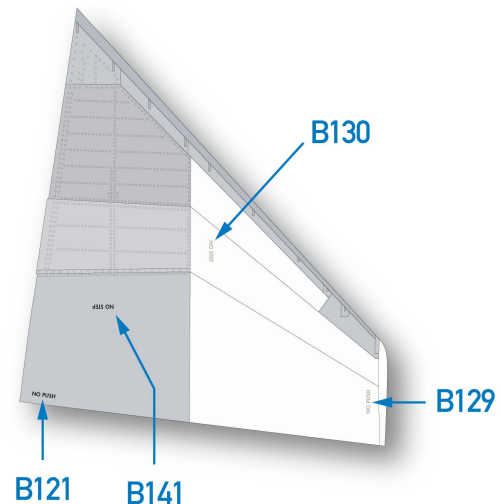
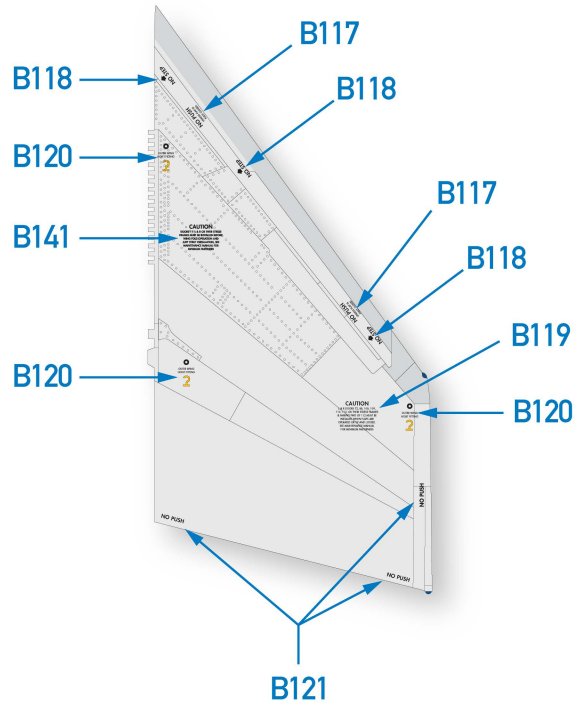
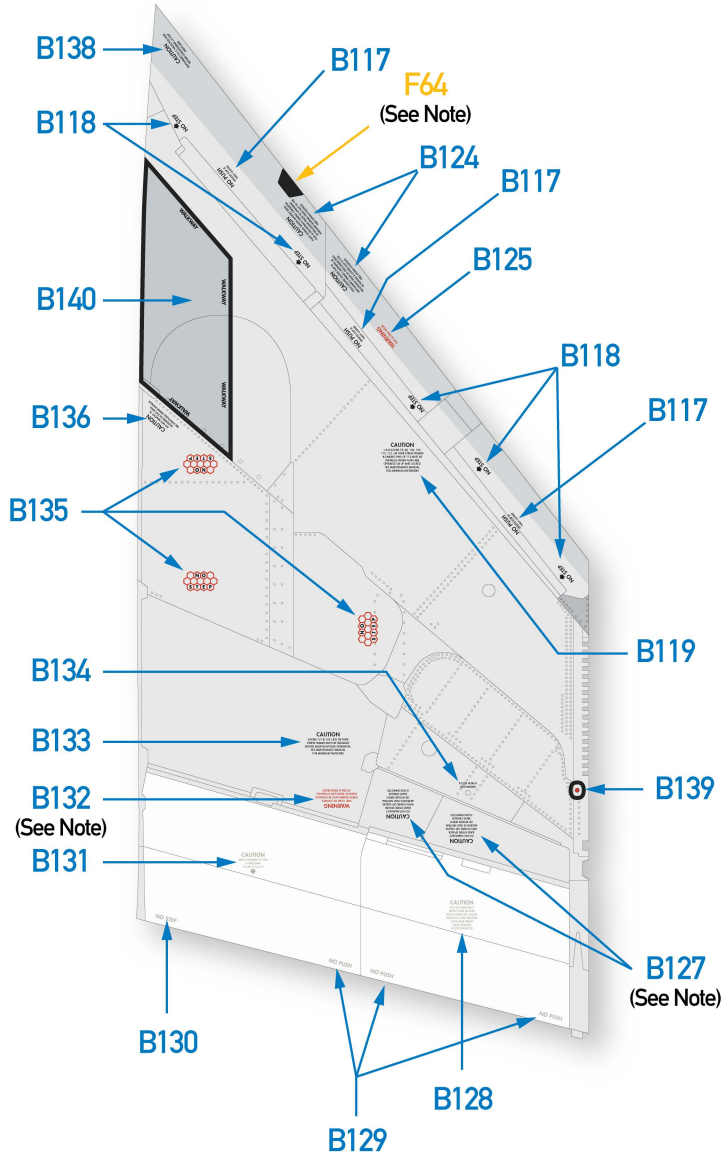

Note:

B127/B132: Note the orientation of these items. Tops of letters face the trailing edge of the wing.

F63/F64: Note orientation of these items. Only found on hard wing F-4Es and F-4Js. Retained even after slats were retrofitted, though sometimes overpainted on F-4S conversions.

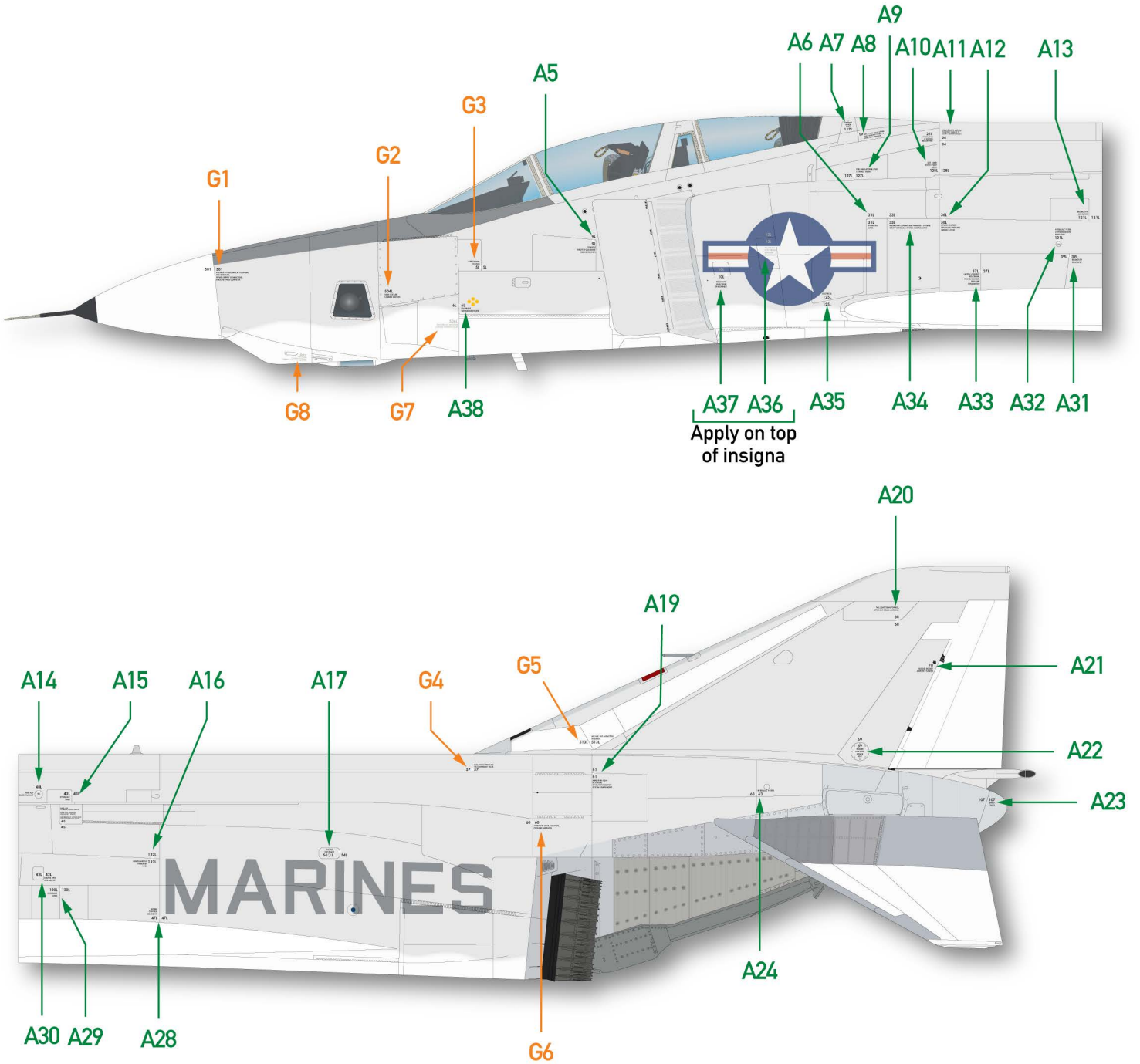

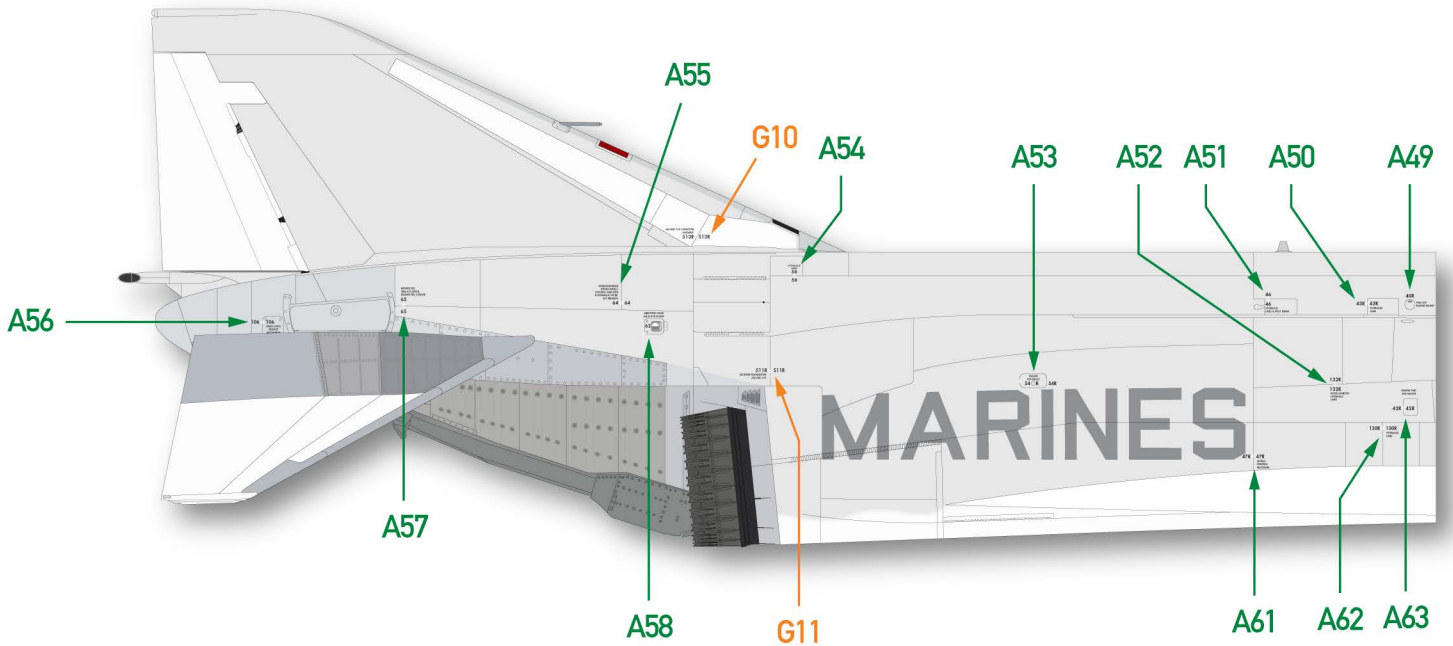
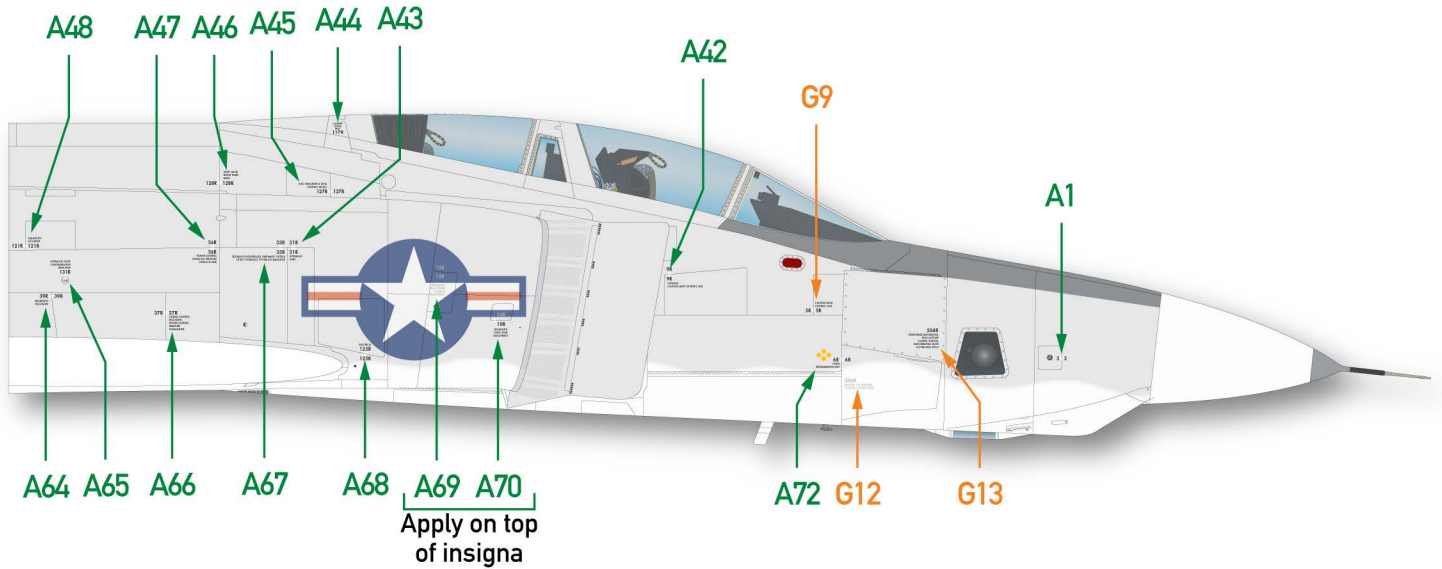

Early production blocks

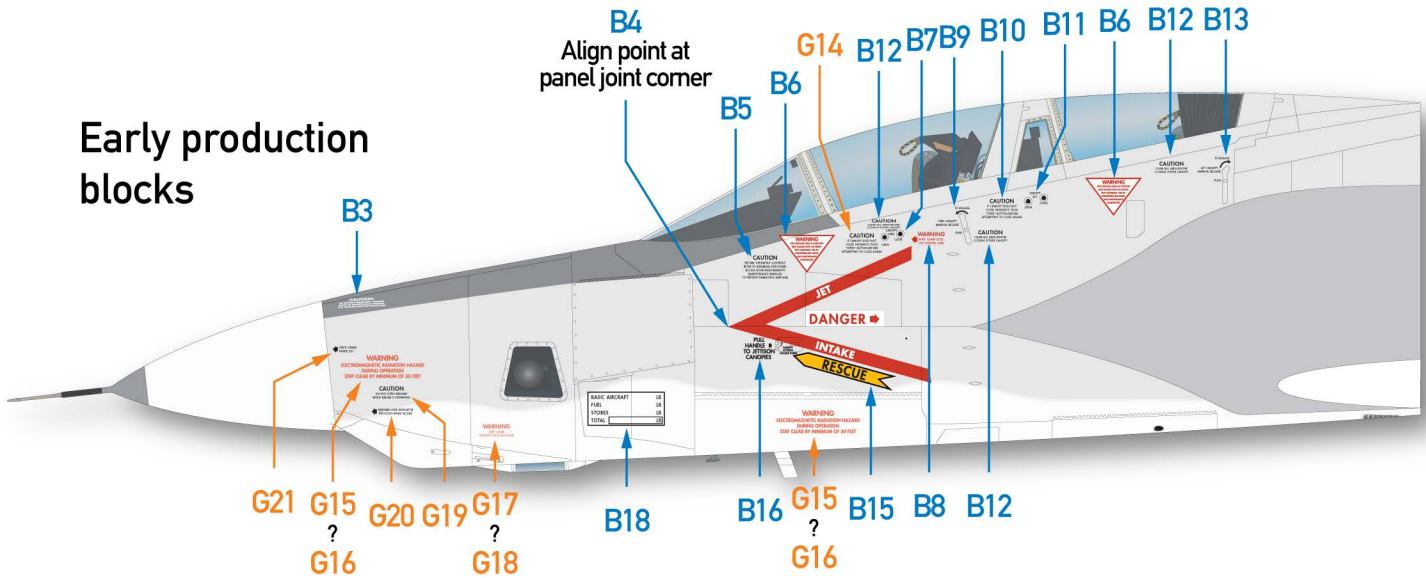

Late production blocks

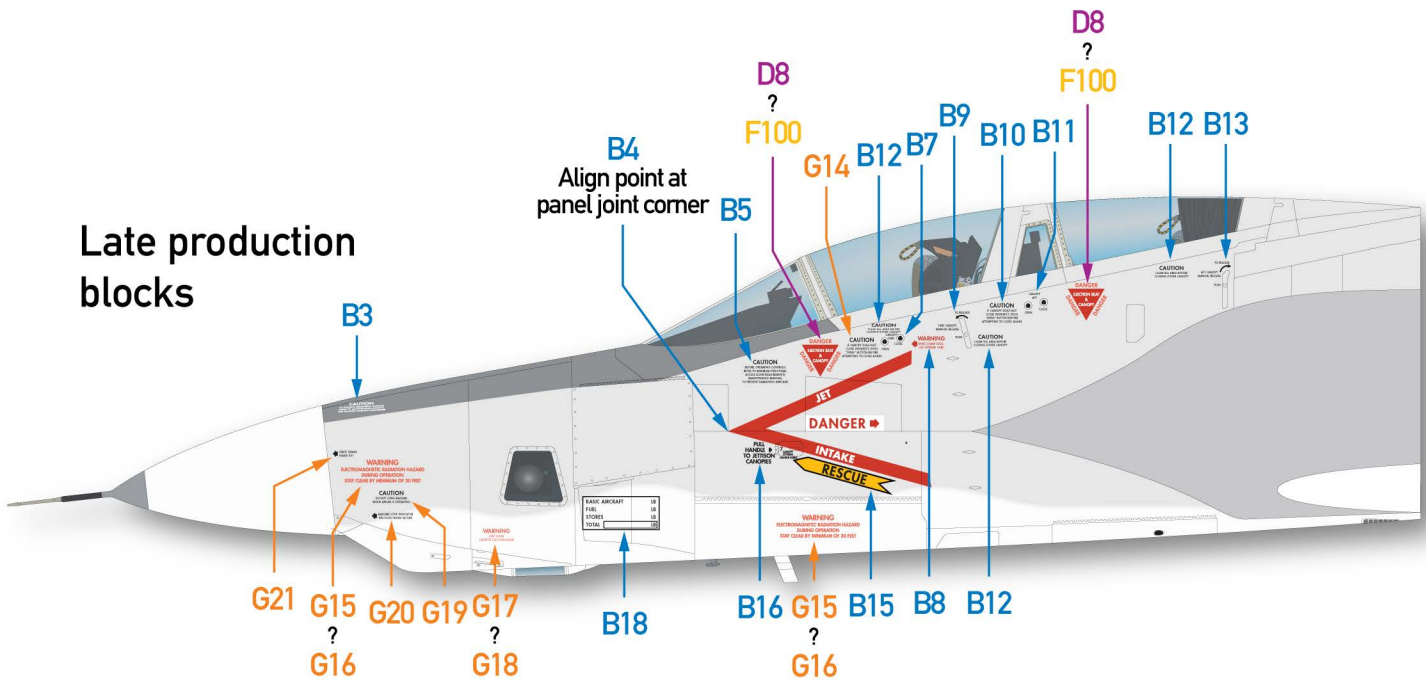

Notes:

G15/G16/G17/G18: The salmon colored stencils (G15/G17) were most commonly used, but the bright red versions (C10/G18) were also applied on some aircraft.

D8/F100: The white-on-red (USAF style) ejection warning triangle was introduced in January 1966 from Block 25 onwards (BuNo 153095). Older aircraft retained the earlier style until depot overhaul.

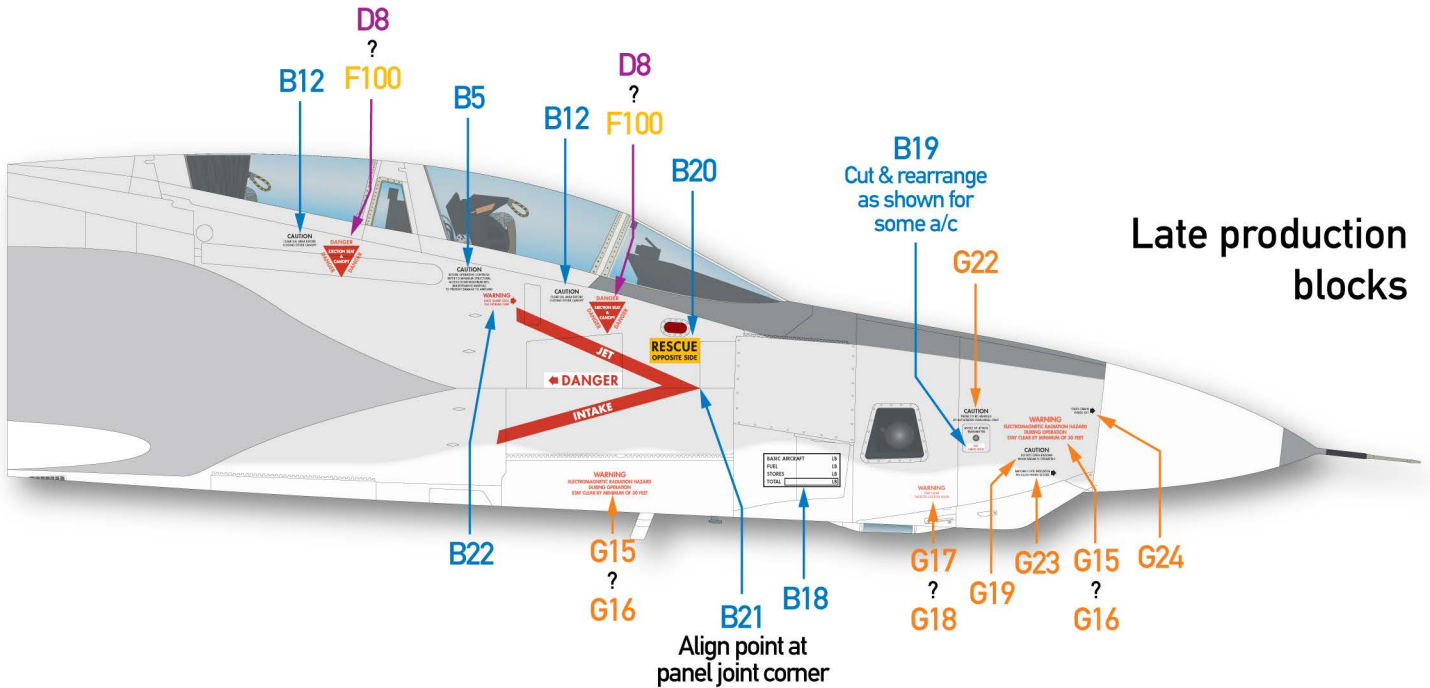
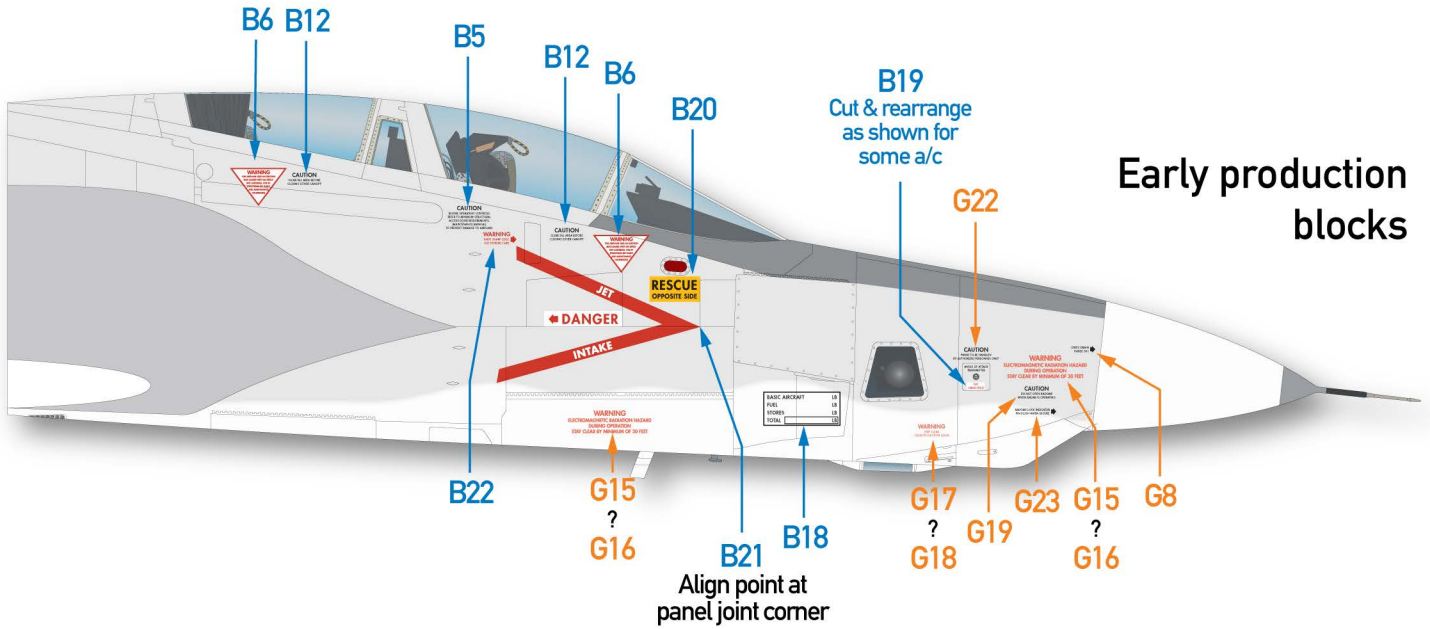

Notes:

G15/G16/G17/G18: The salmon colored stencils (G15/G17) were most commonly used, but the bright red versions (C10/G18) were also applied on some aircraft.

D8/F100: The white-on-red (USAF style) ejection warning triangle was introduced in January 1966 from Block 25 onwards (BuNo 153095). Older aircraft retained the earlier style until depot overhaul.

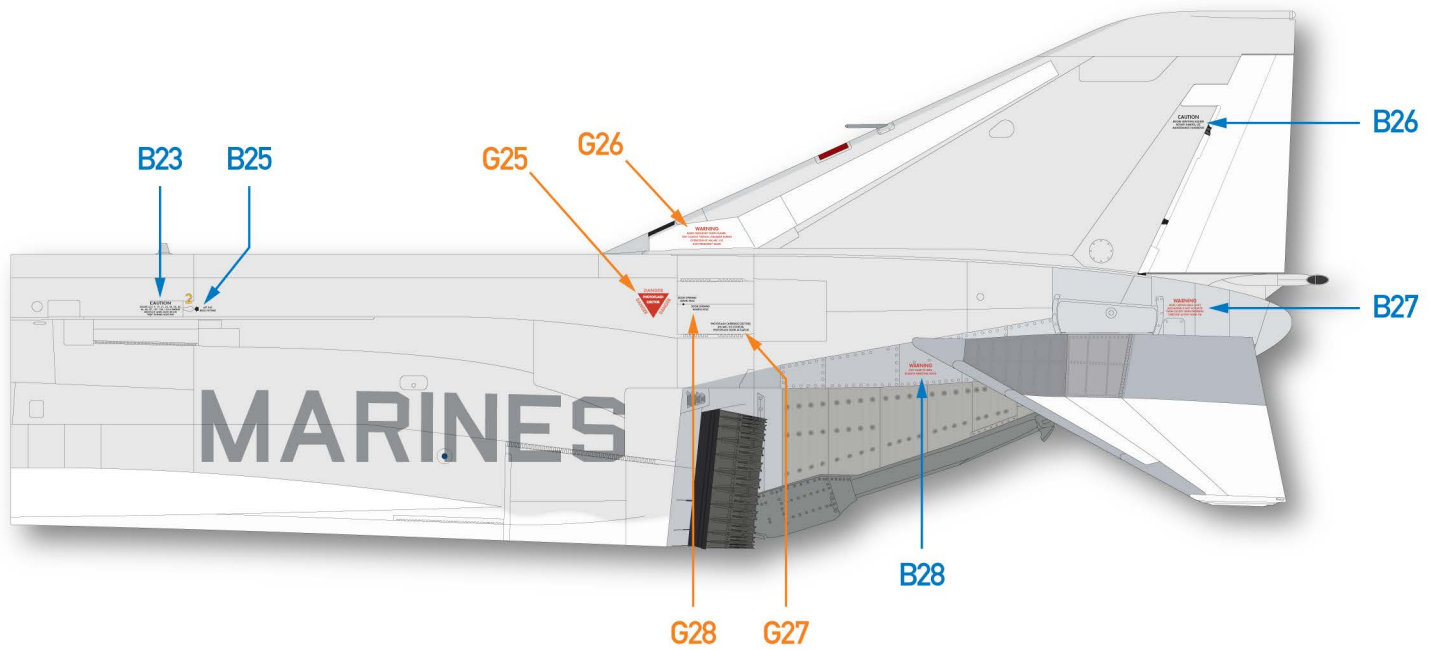
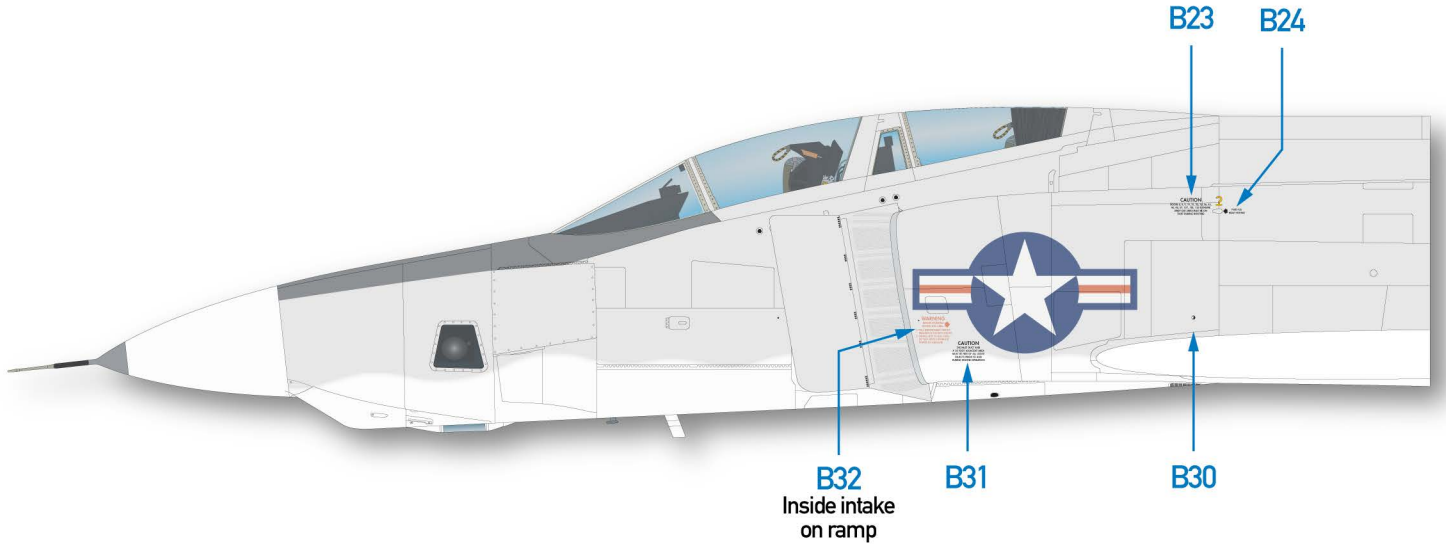

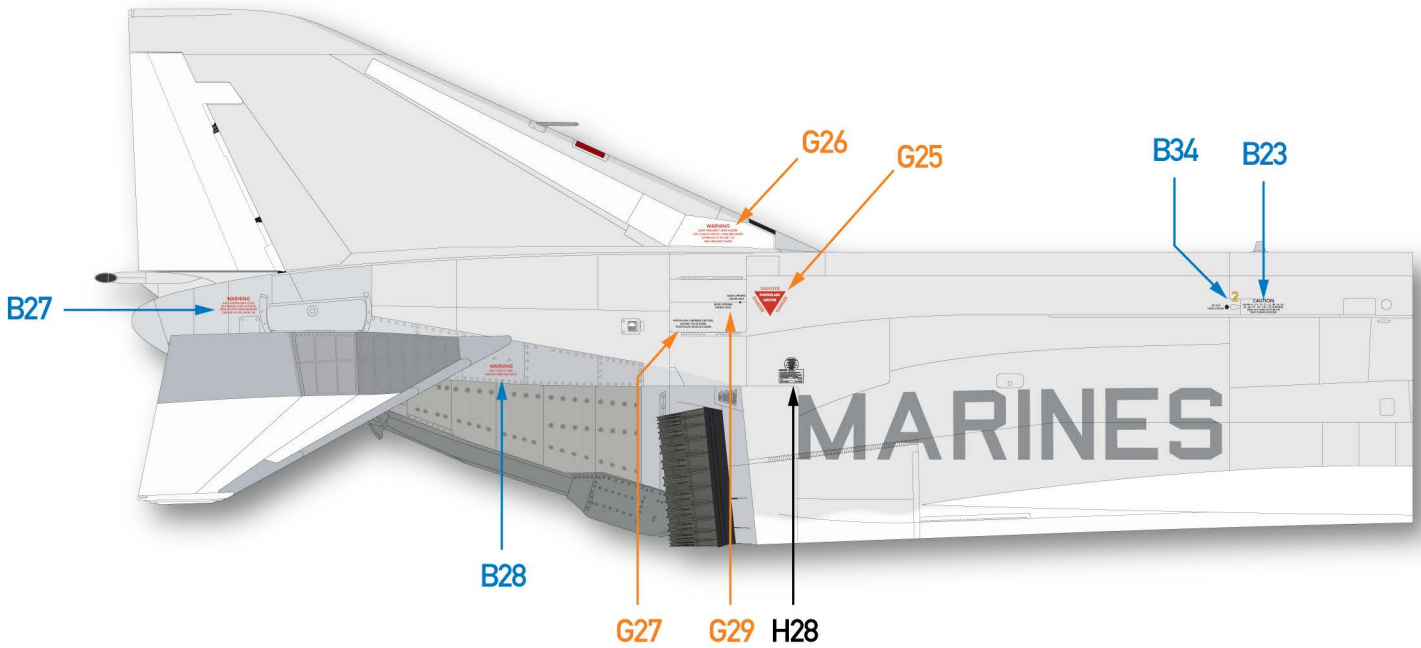
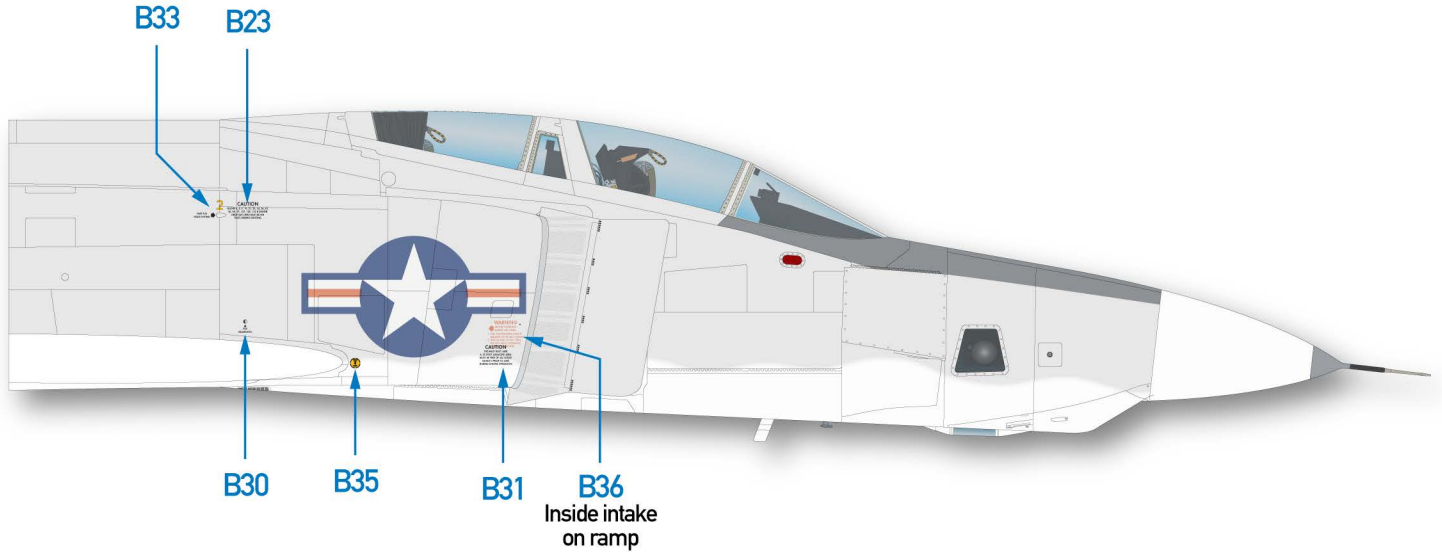

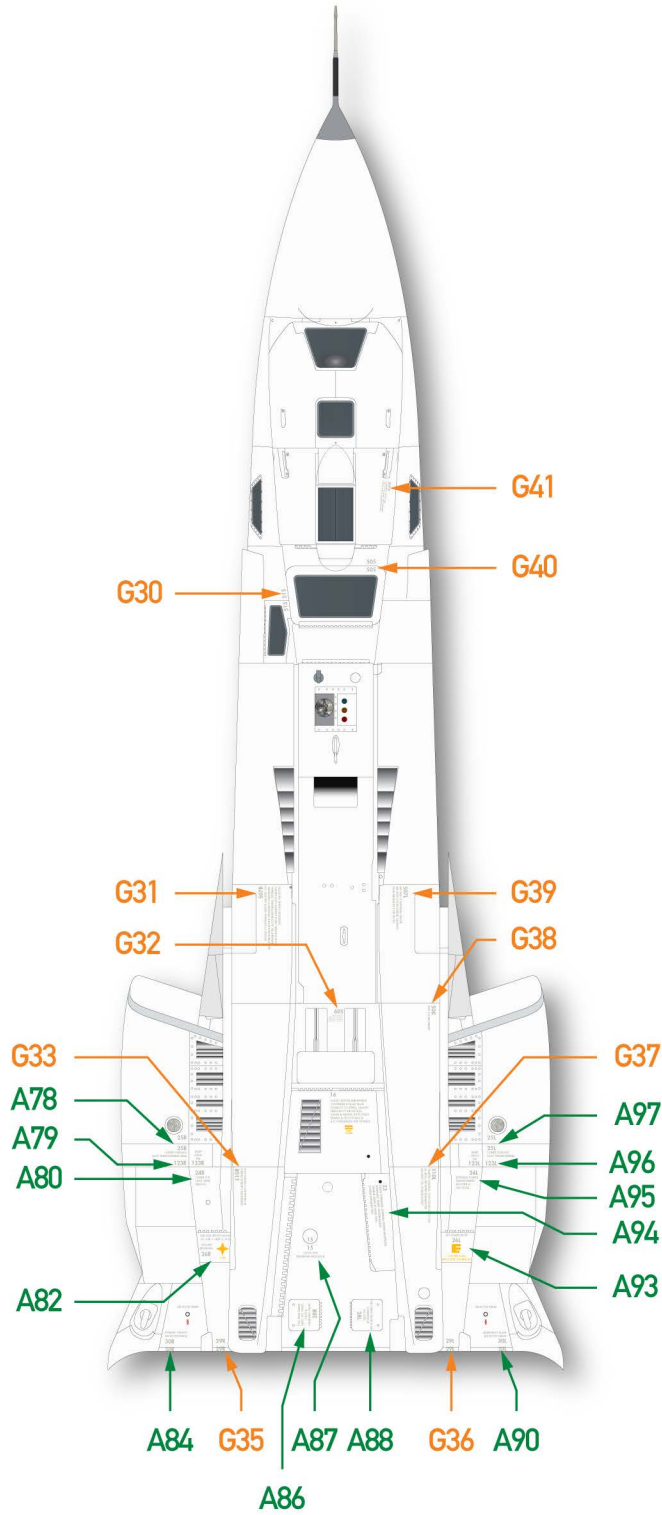

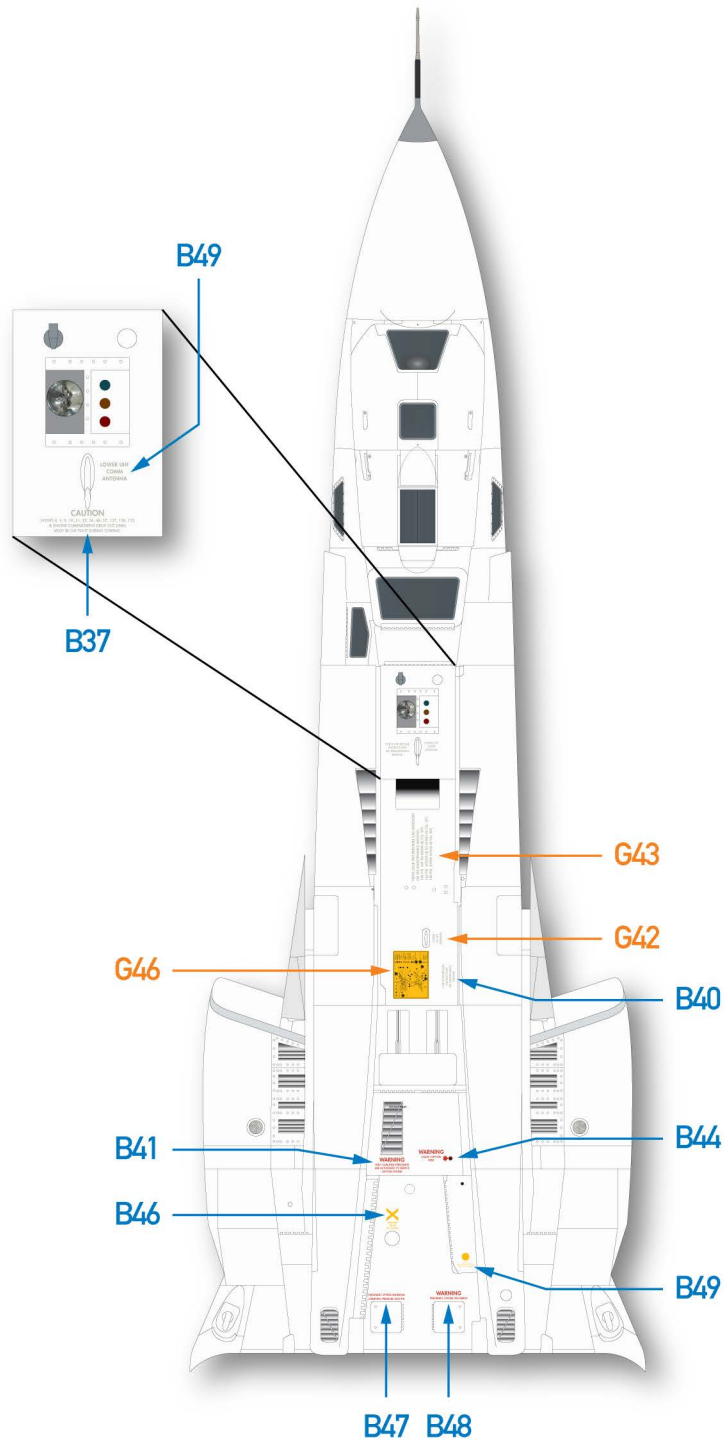

↑
Forward

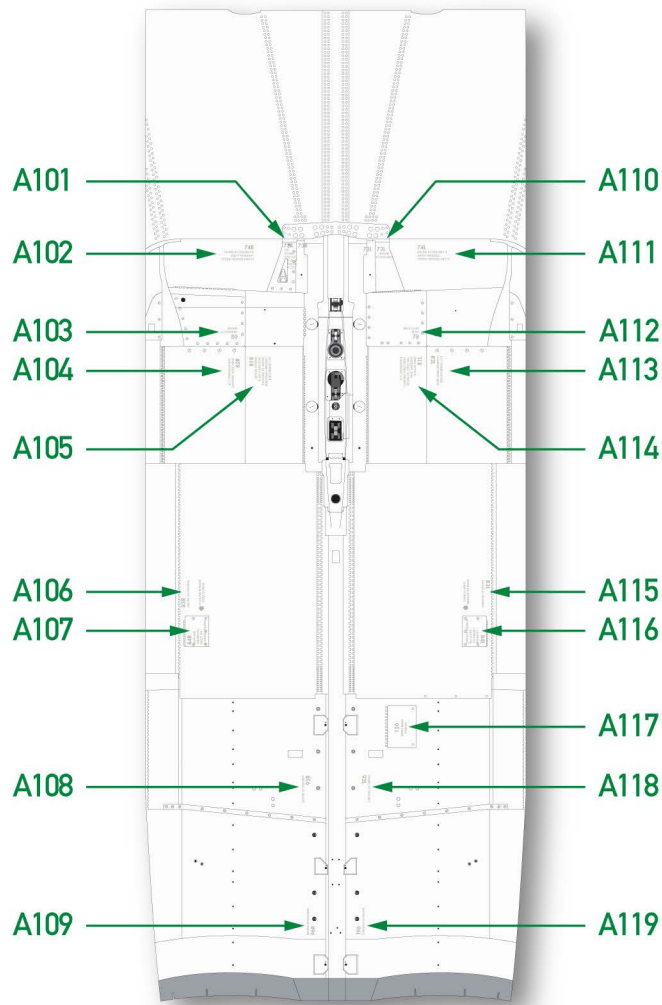

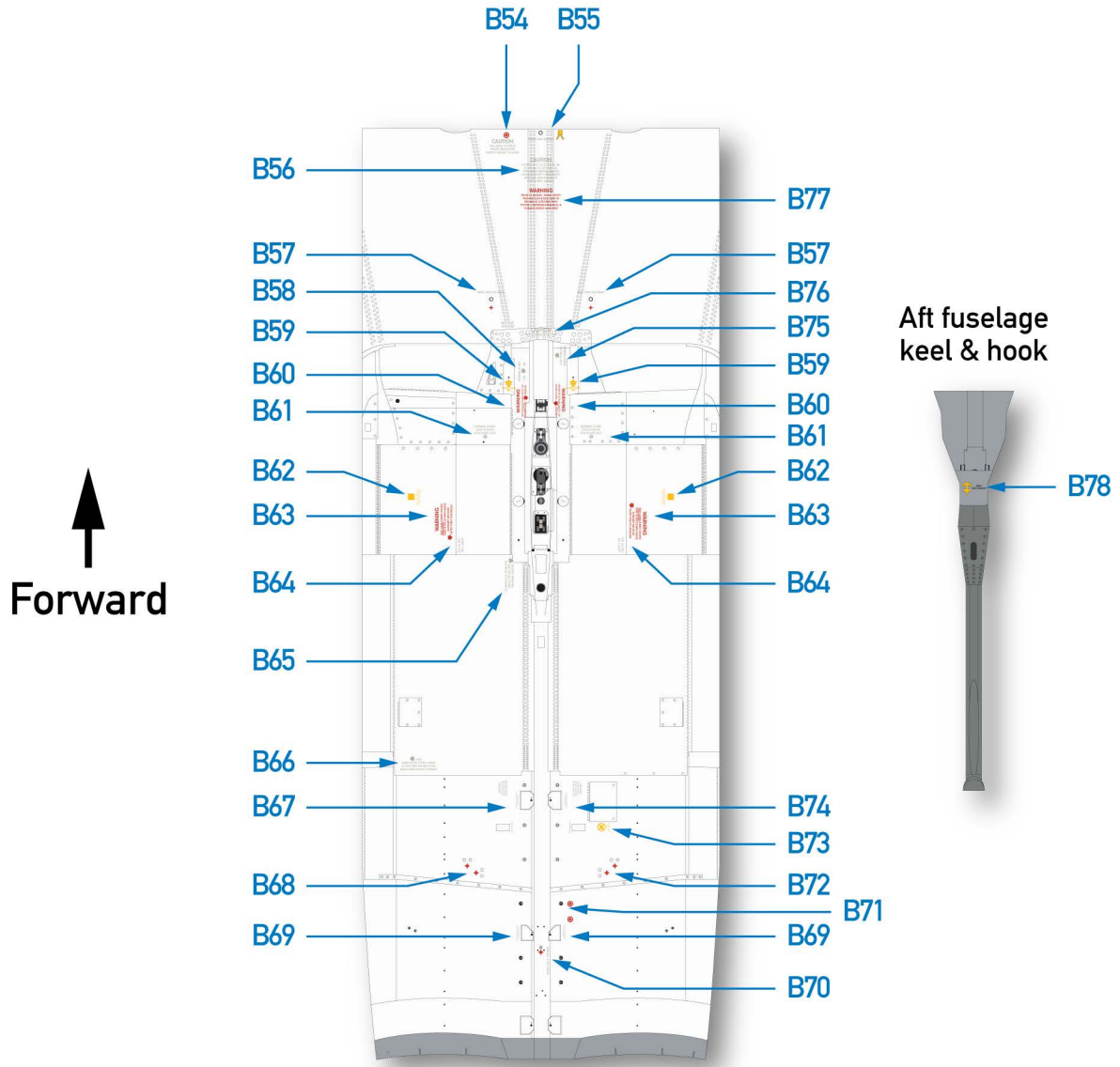

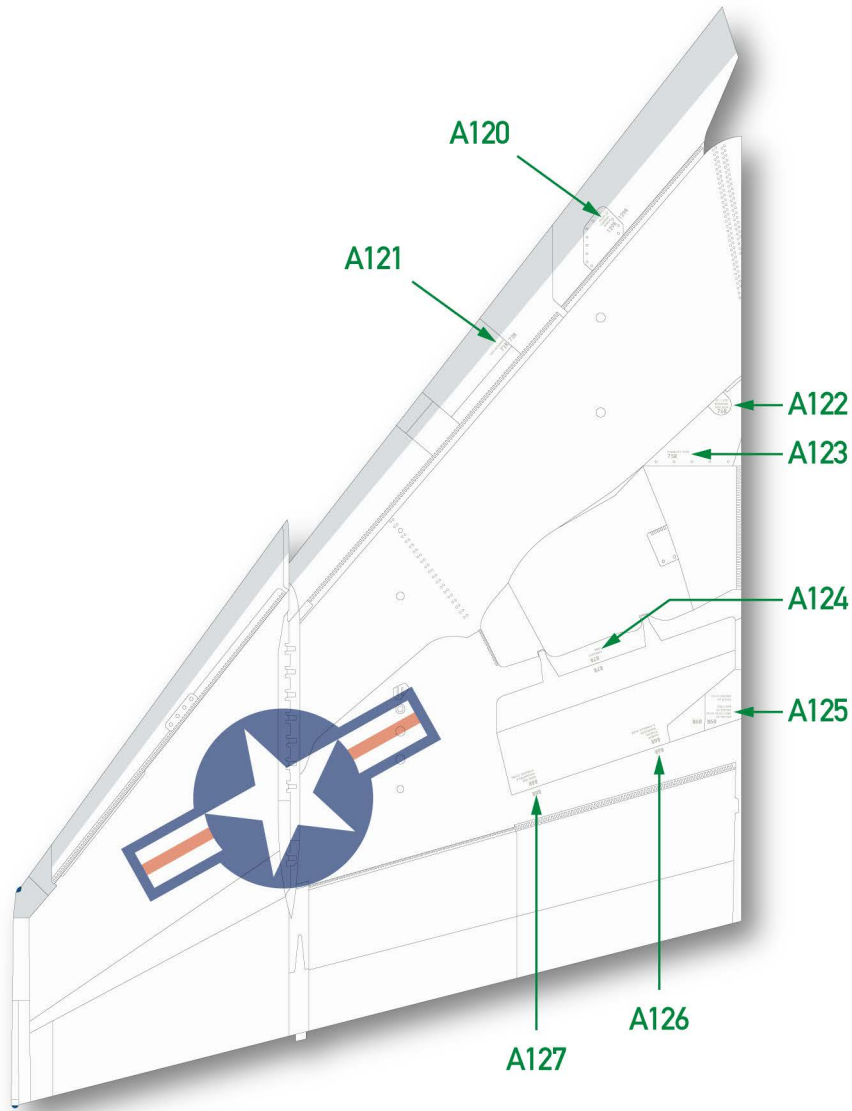

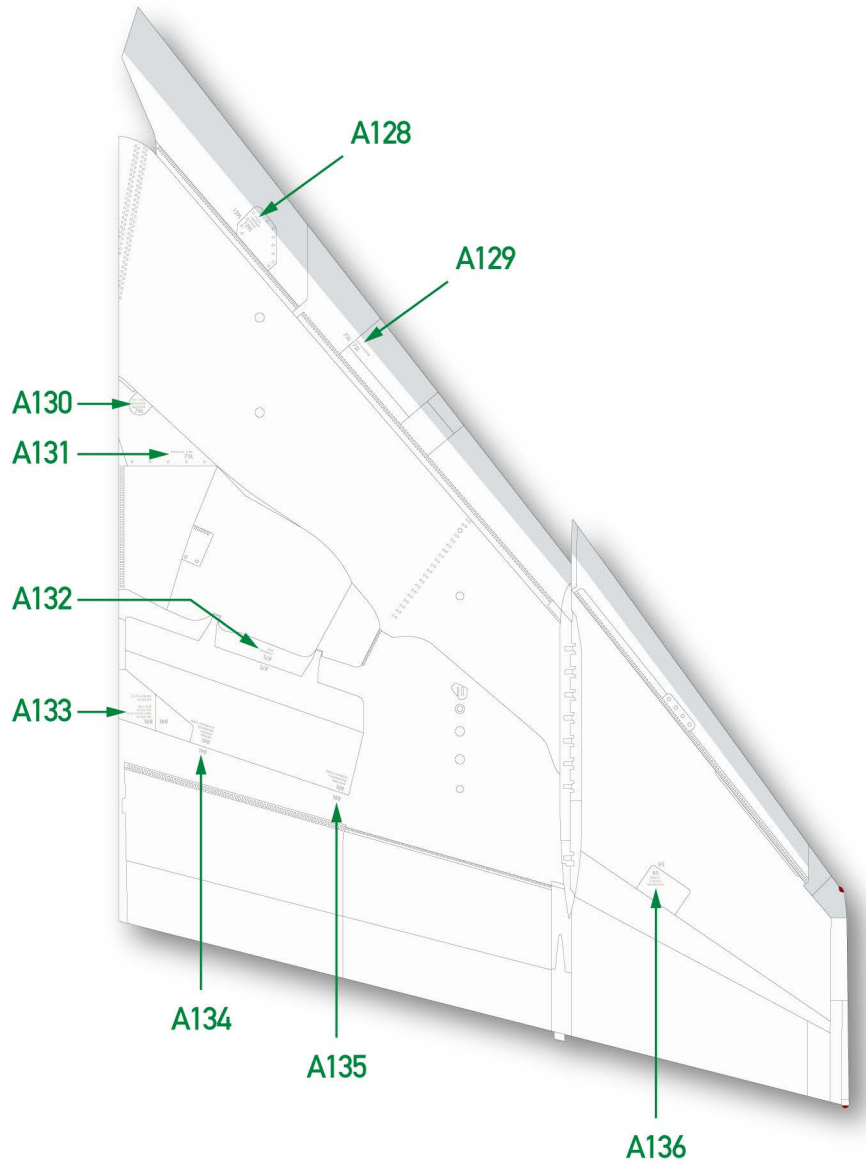

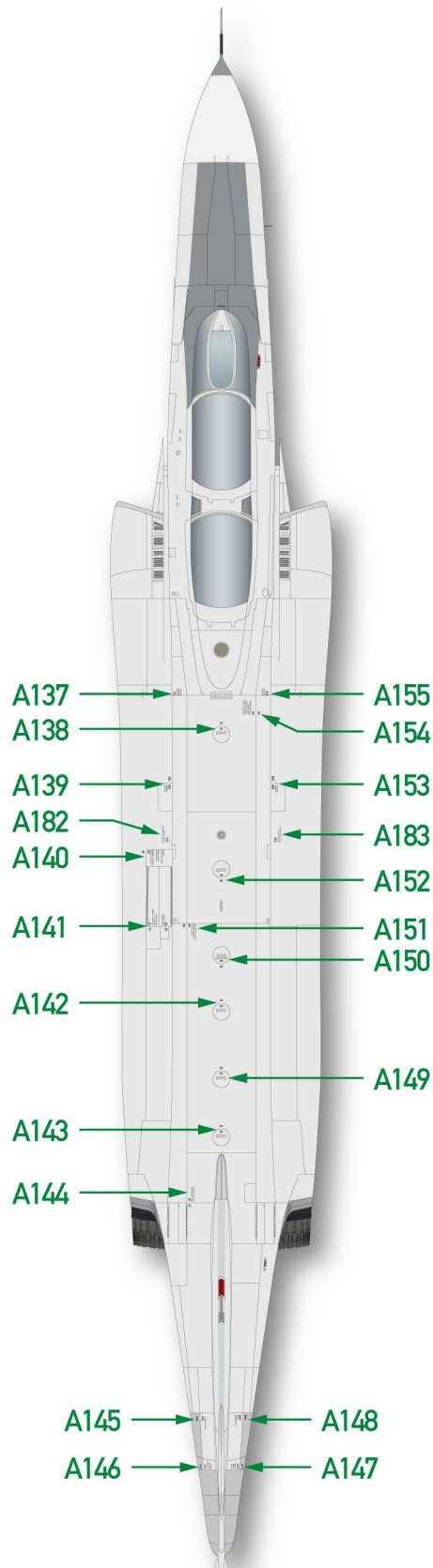

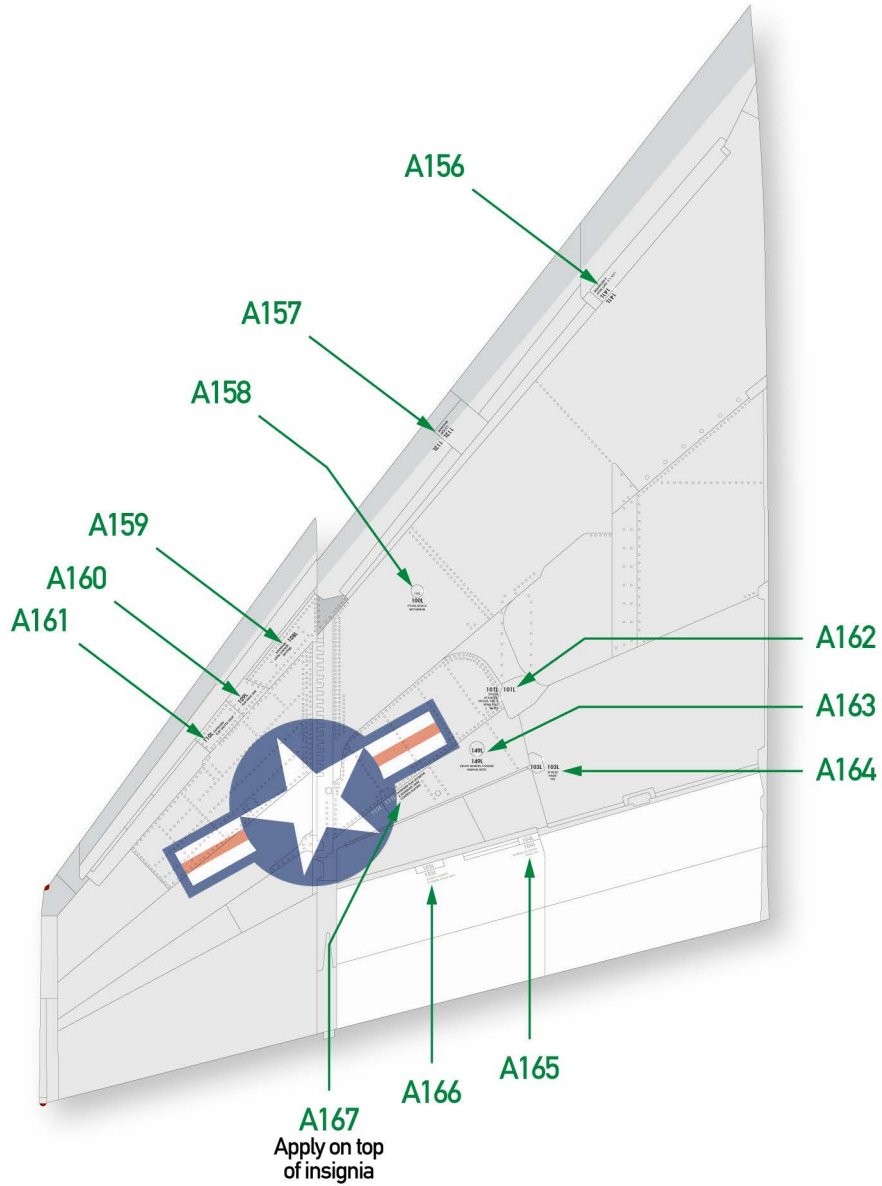

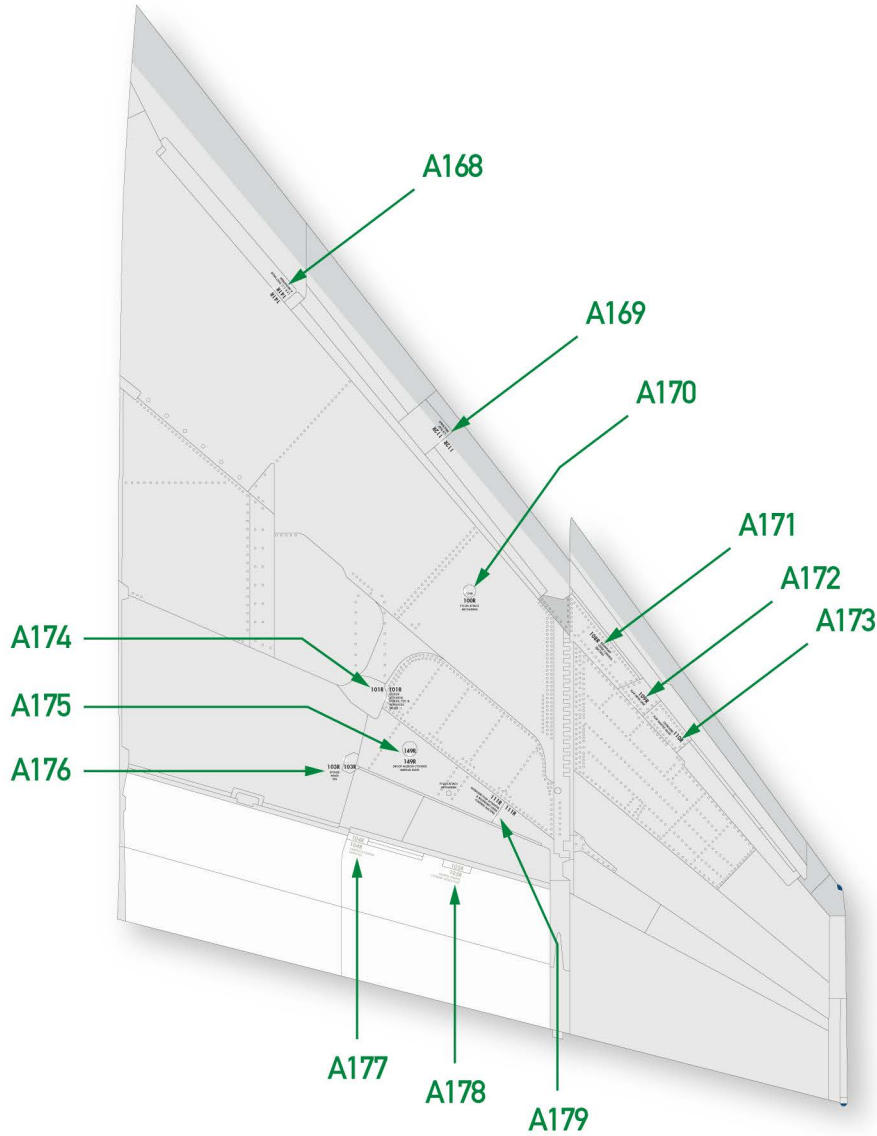

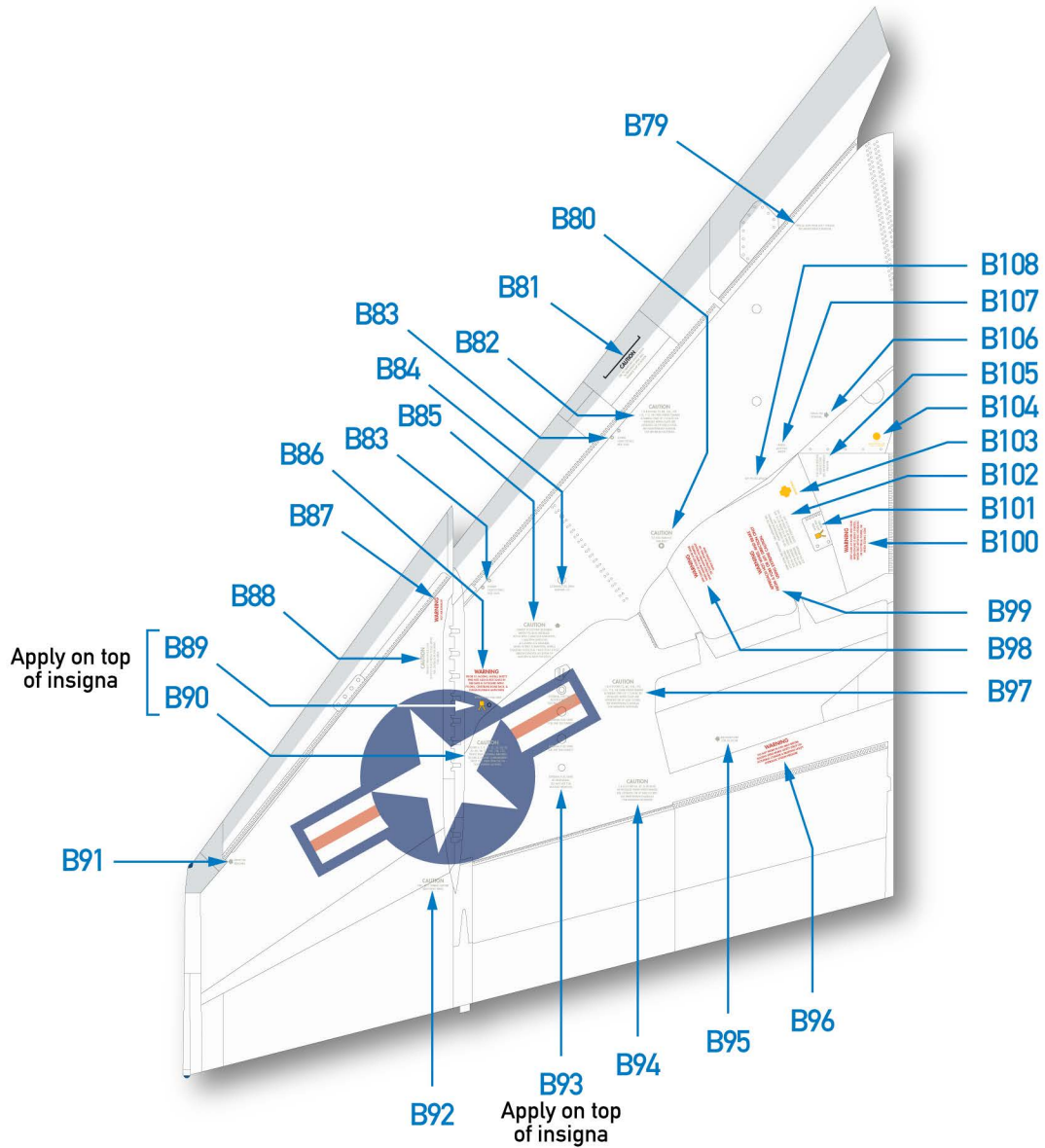

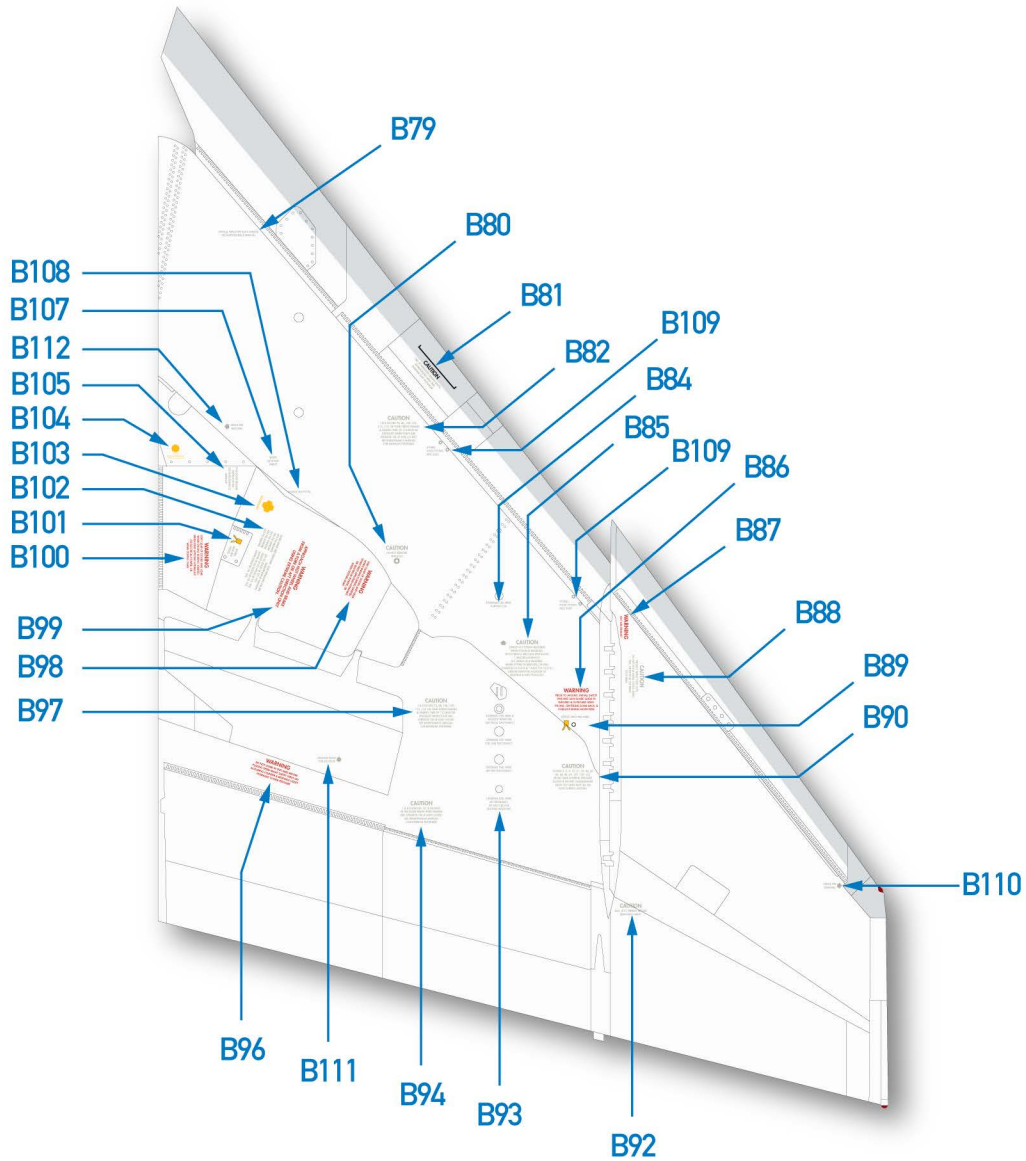

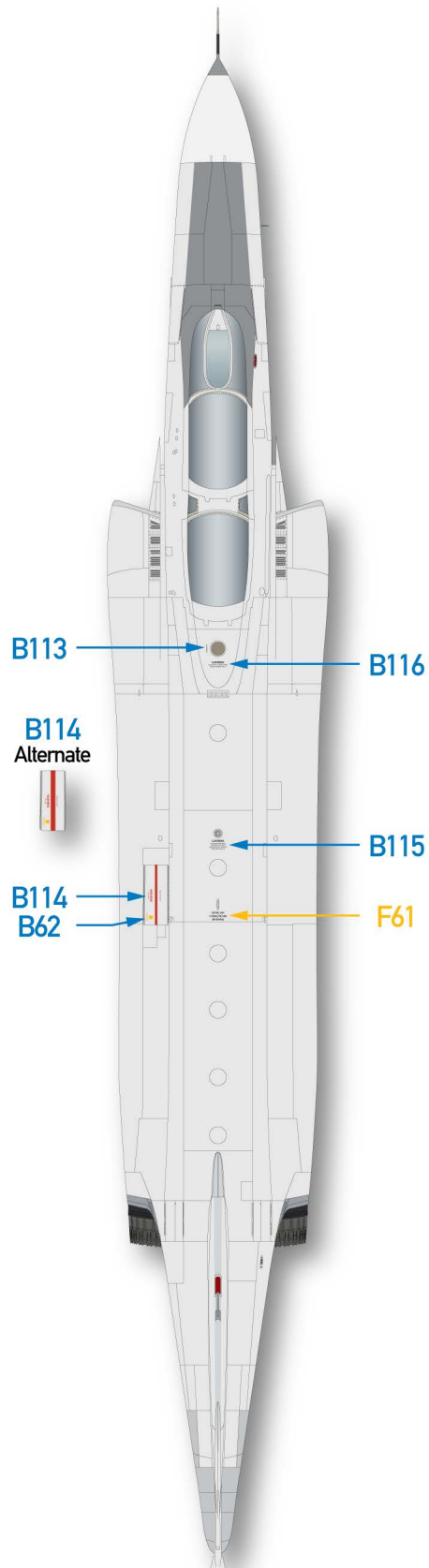

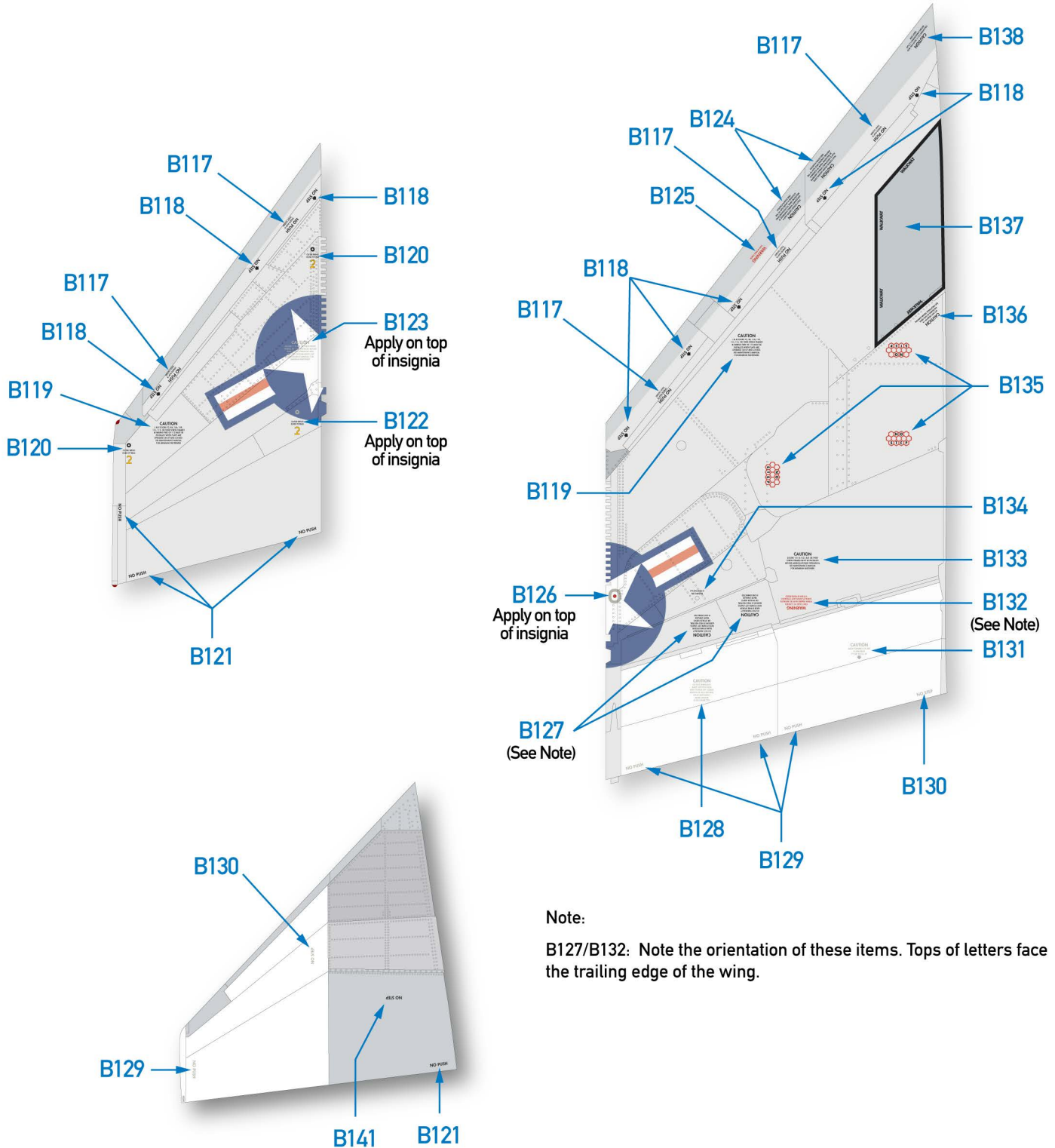

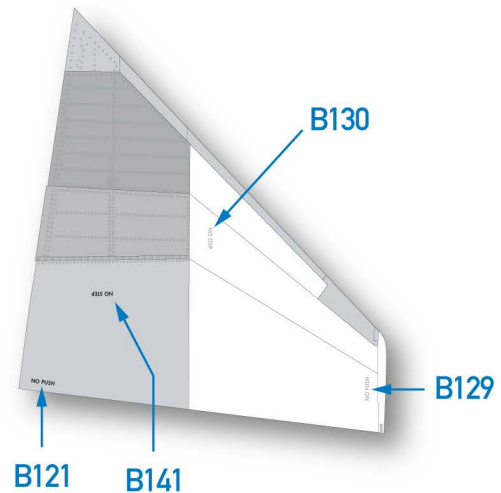
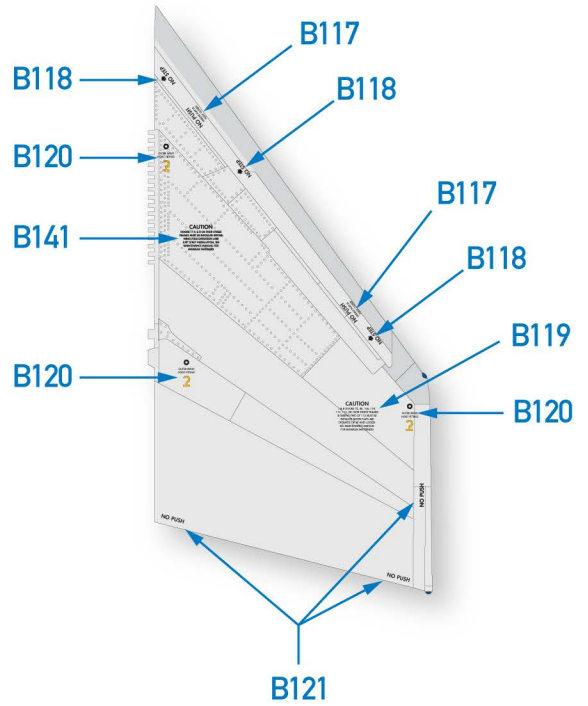
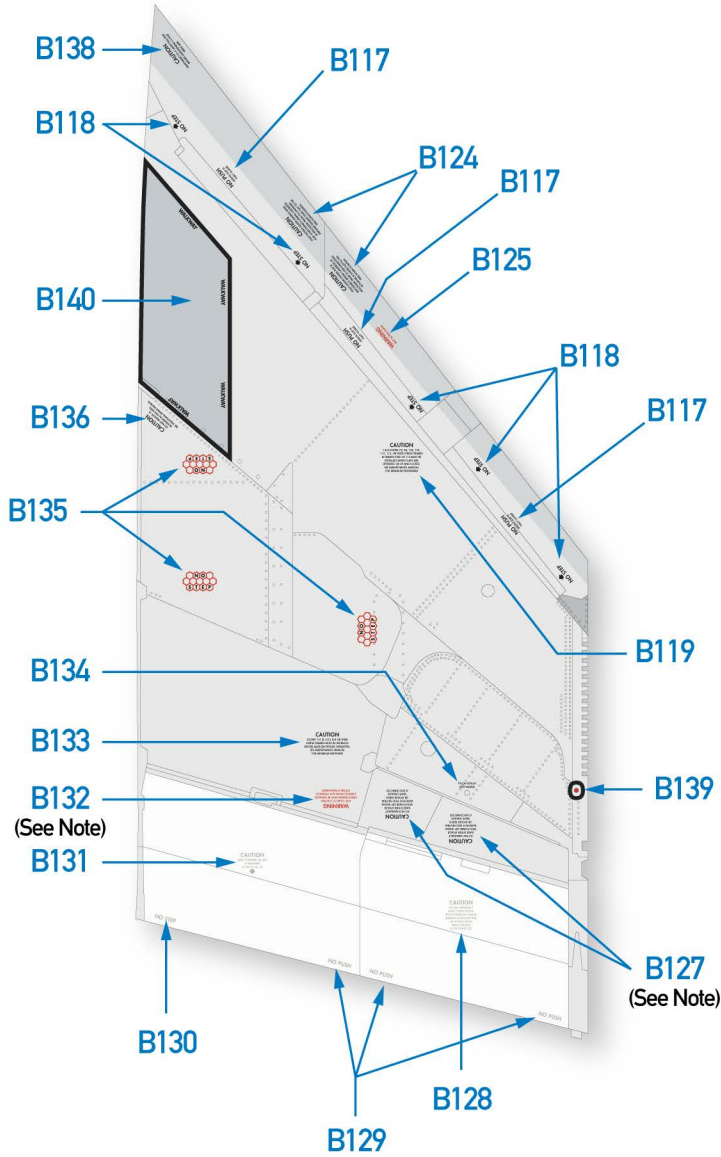

Note:
B127/B132: Note the orientation of these items. Tops of letters face the trailing edge of the wing.

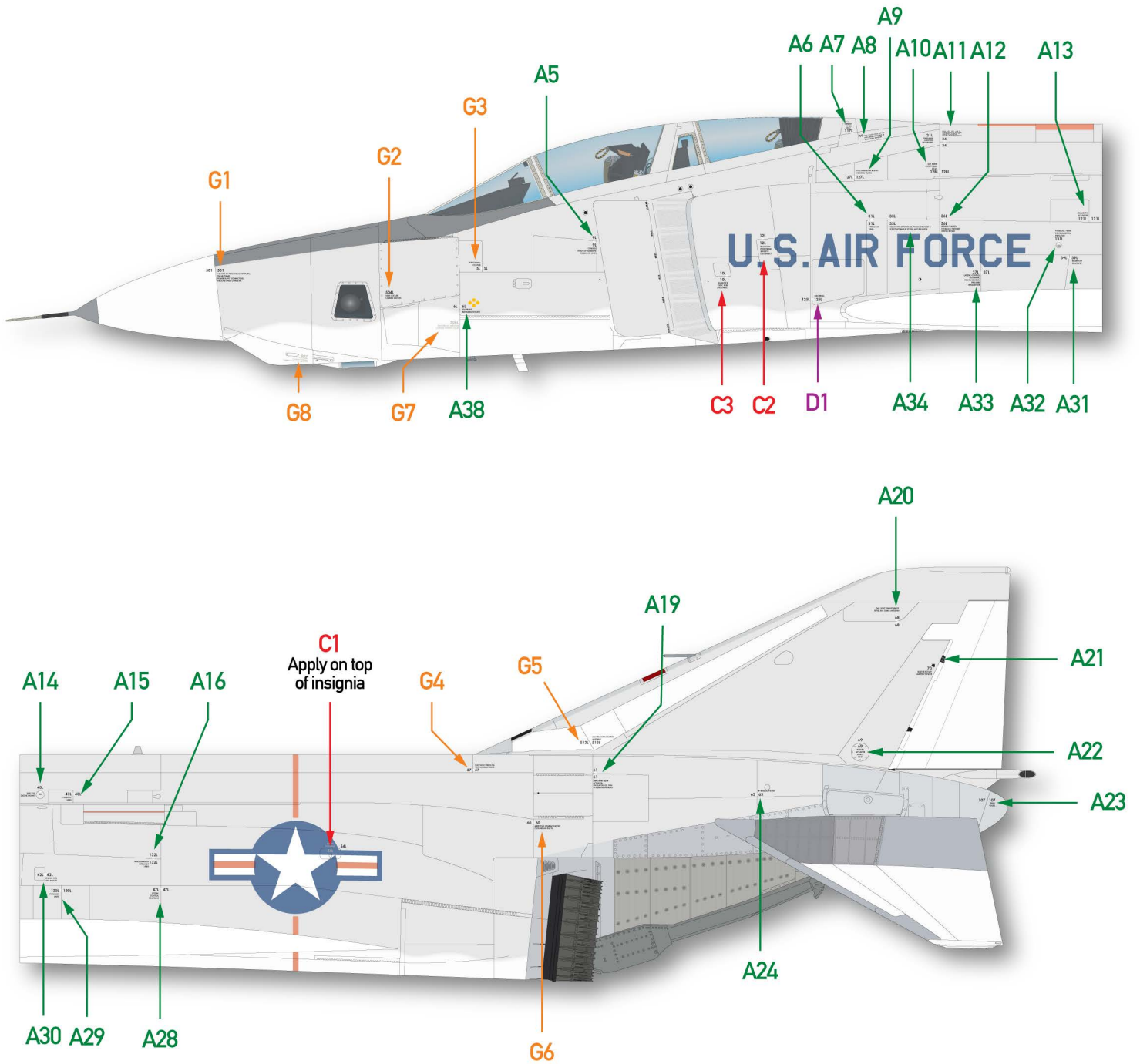

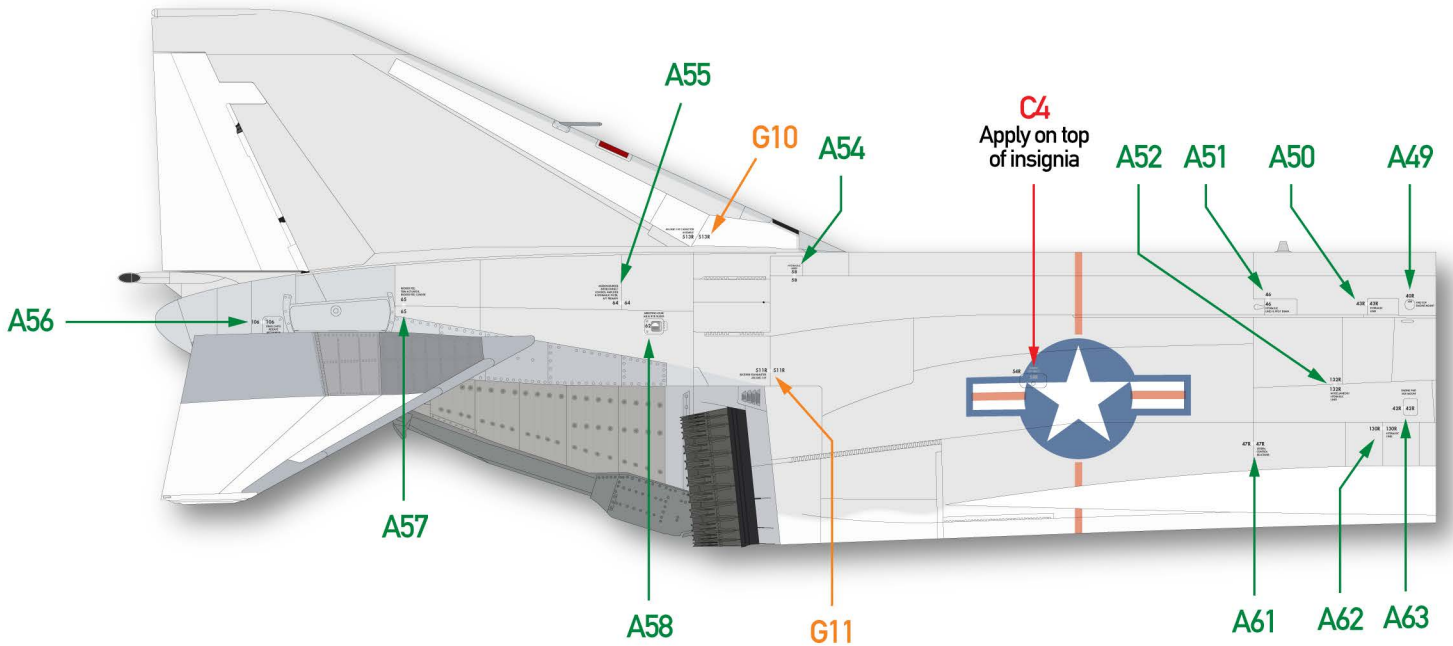
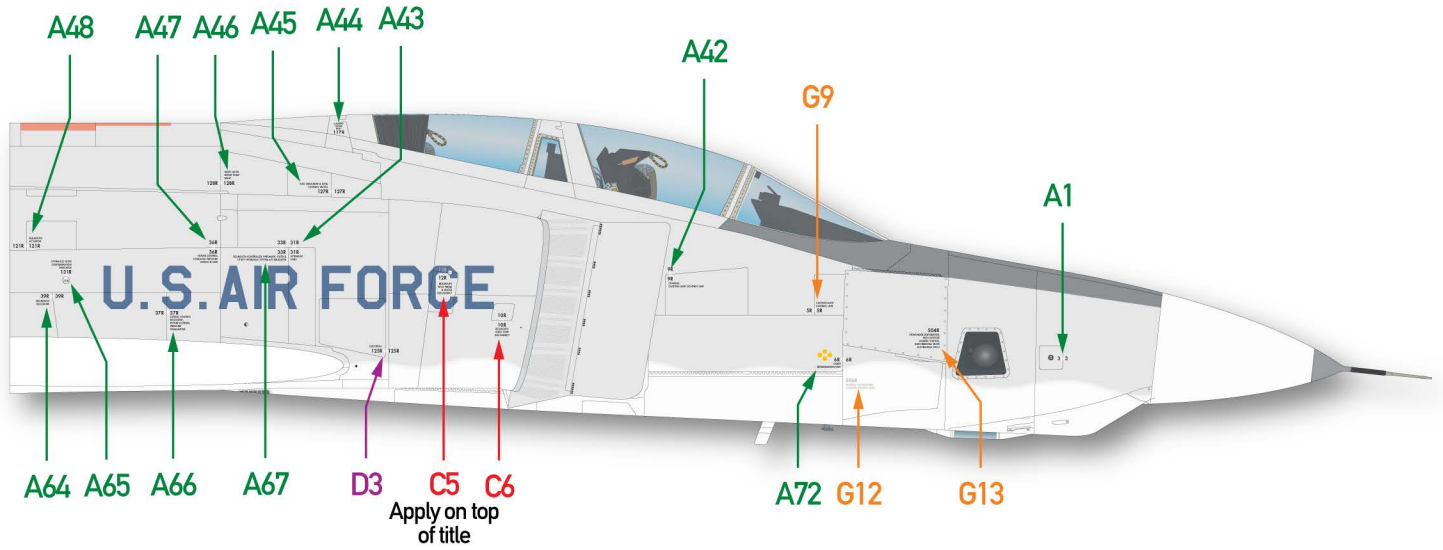

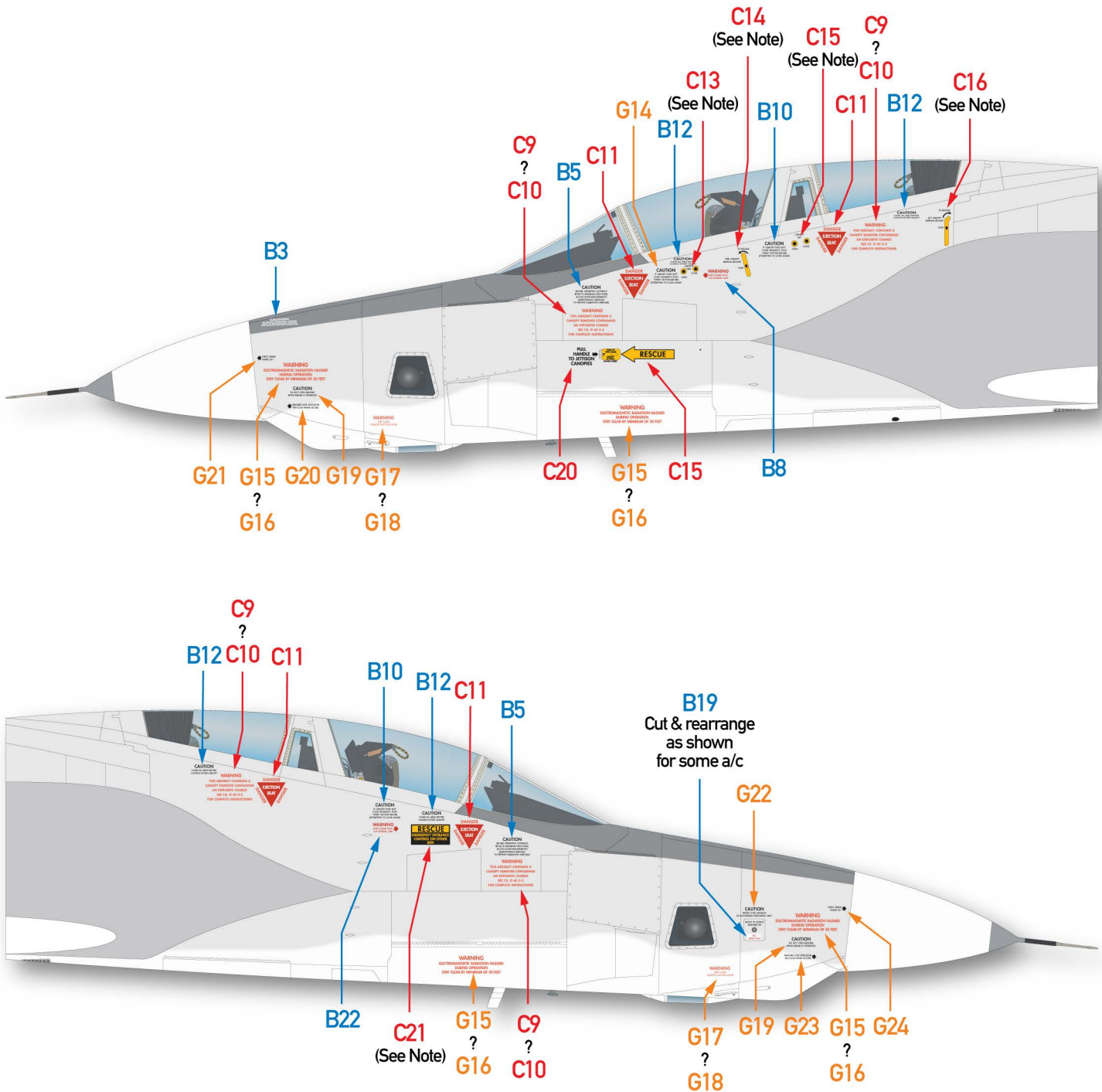

Notes:

C9/C10, G15/G16: The salmon colored stencils (C9/G15) were most commonly used, but the bright red versions (C10/G16) were also applied on some aircraft.

C13 - C16: Canopy open/close buttons & handles are provided to fit the ZM and Tamiya kit scribing (as closely as can make them), as well as in the actual scale size and shape based on tracings and measurements of these items on an actual F-4. The kit scribing (on every existing 1/48 F-4 kit we have found) is not really accurate in size or shape. We recommend filling the scribed detail and using the "B" versions of these decals, which are accurate scale representations of the real thing.

C21: Two variations are provided. The one shown in the drawing is by far the most common.

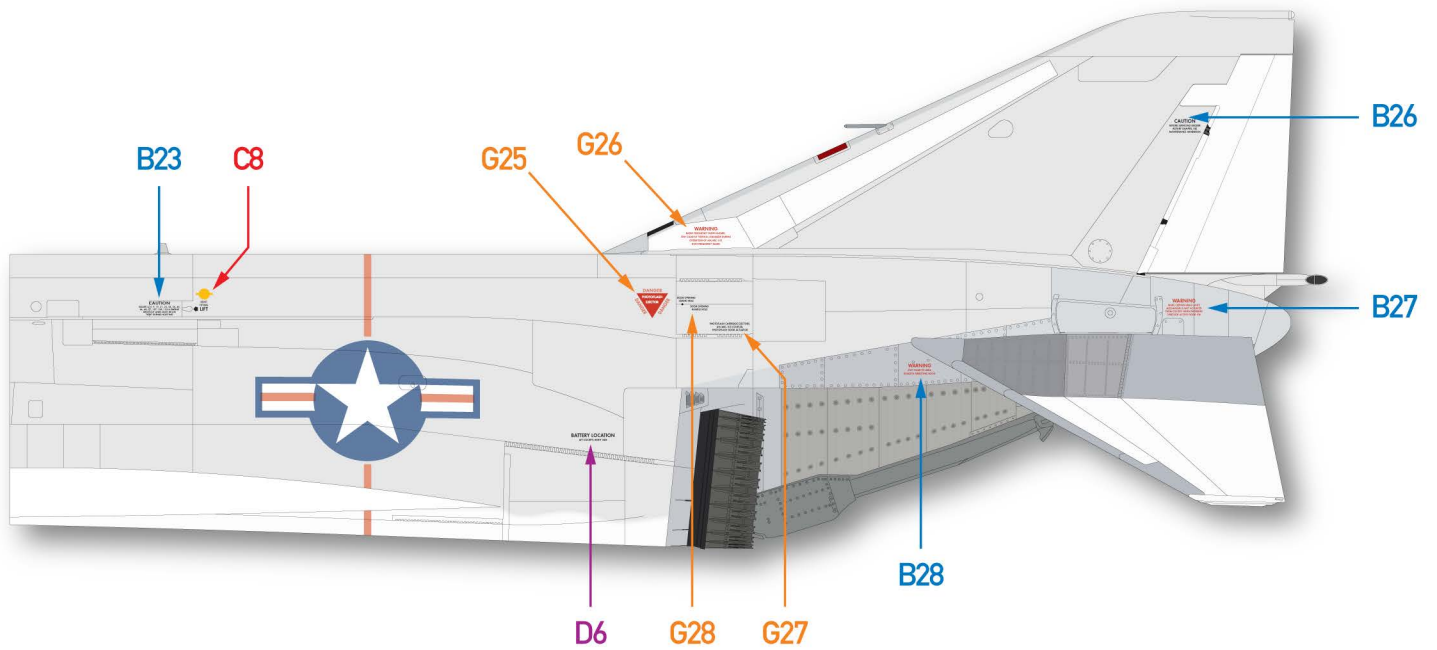
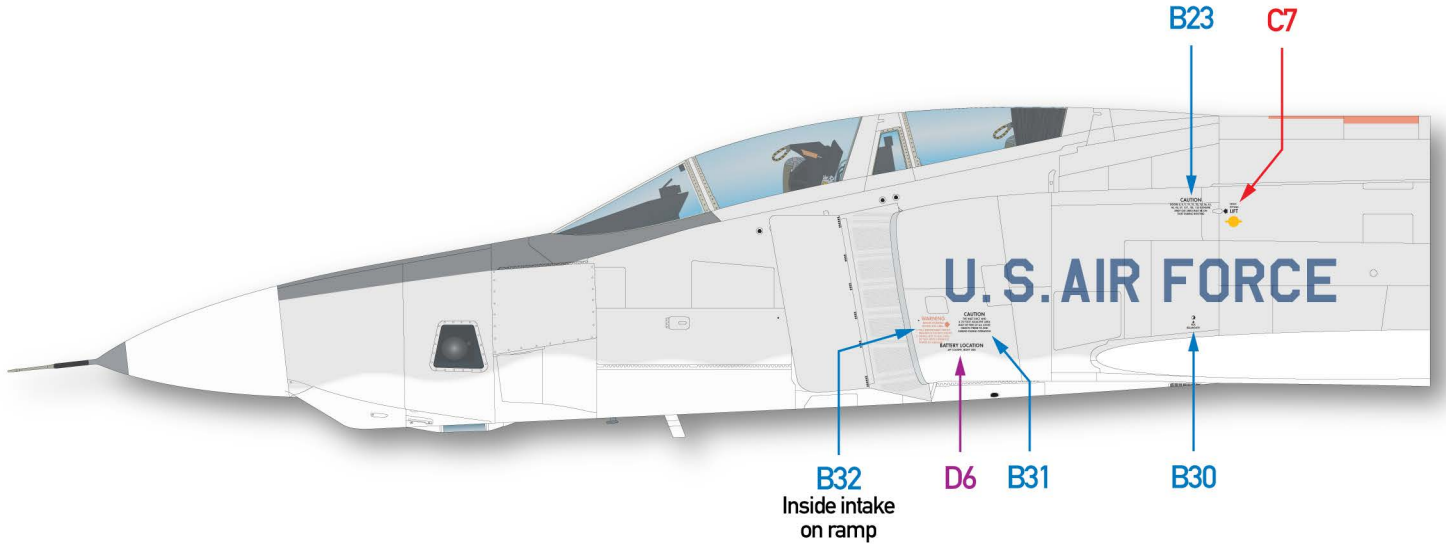

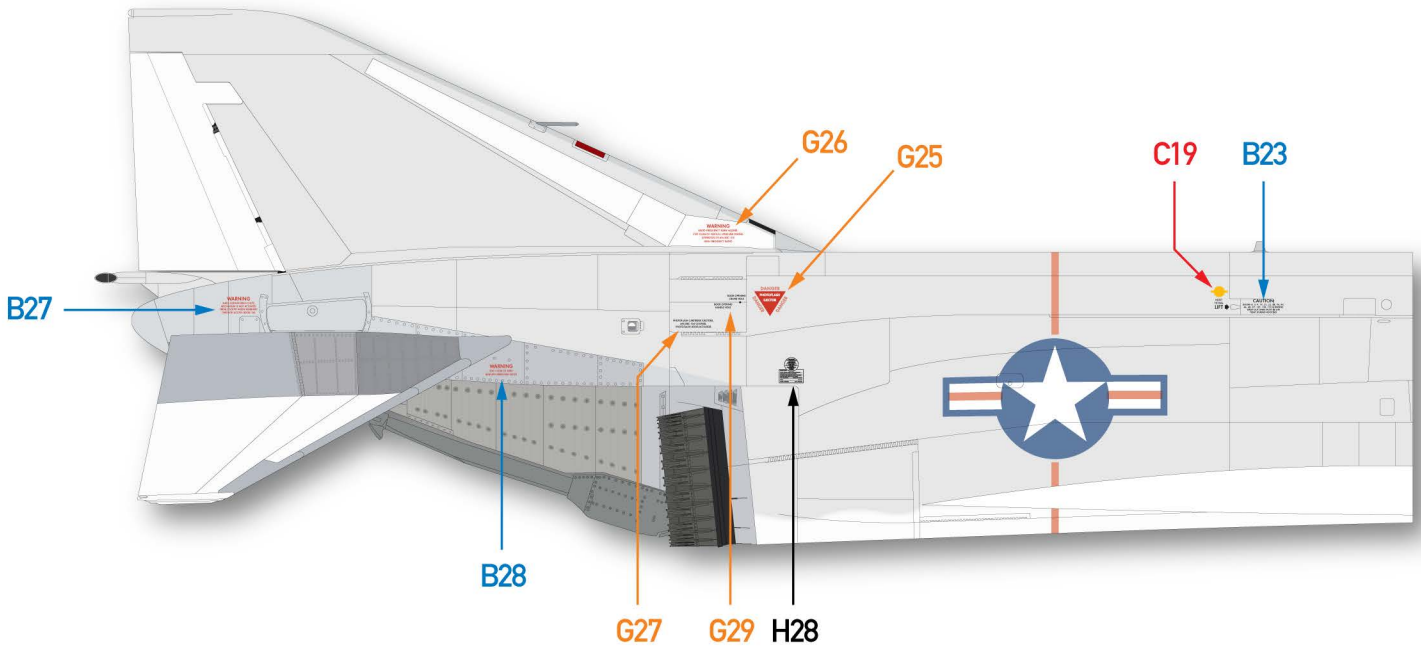
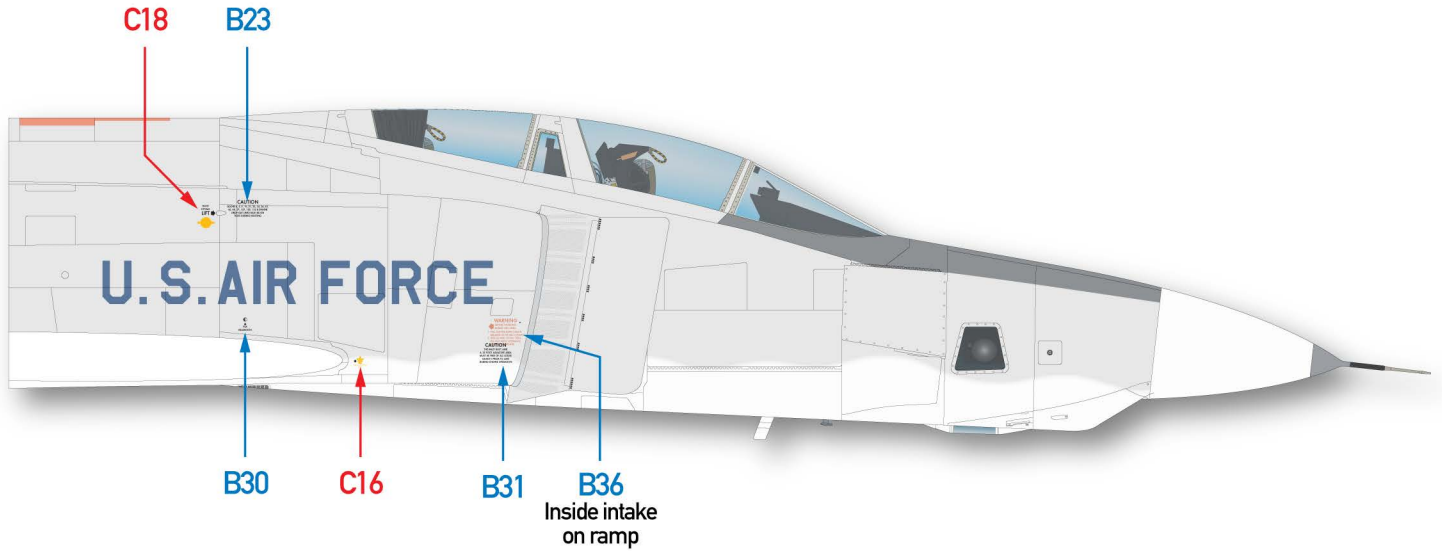

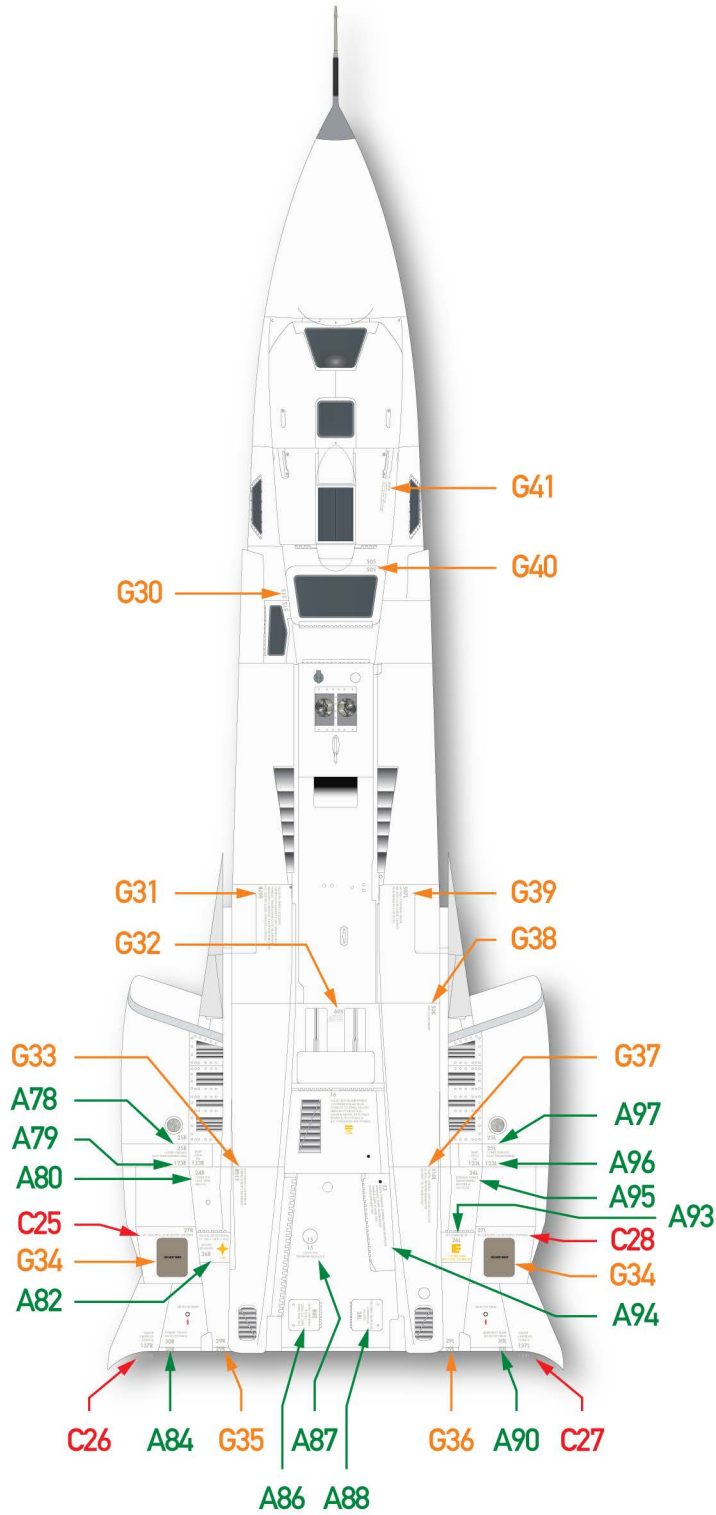

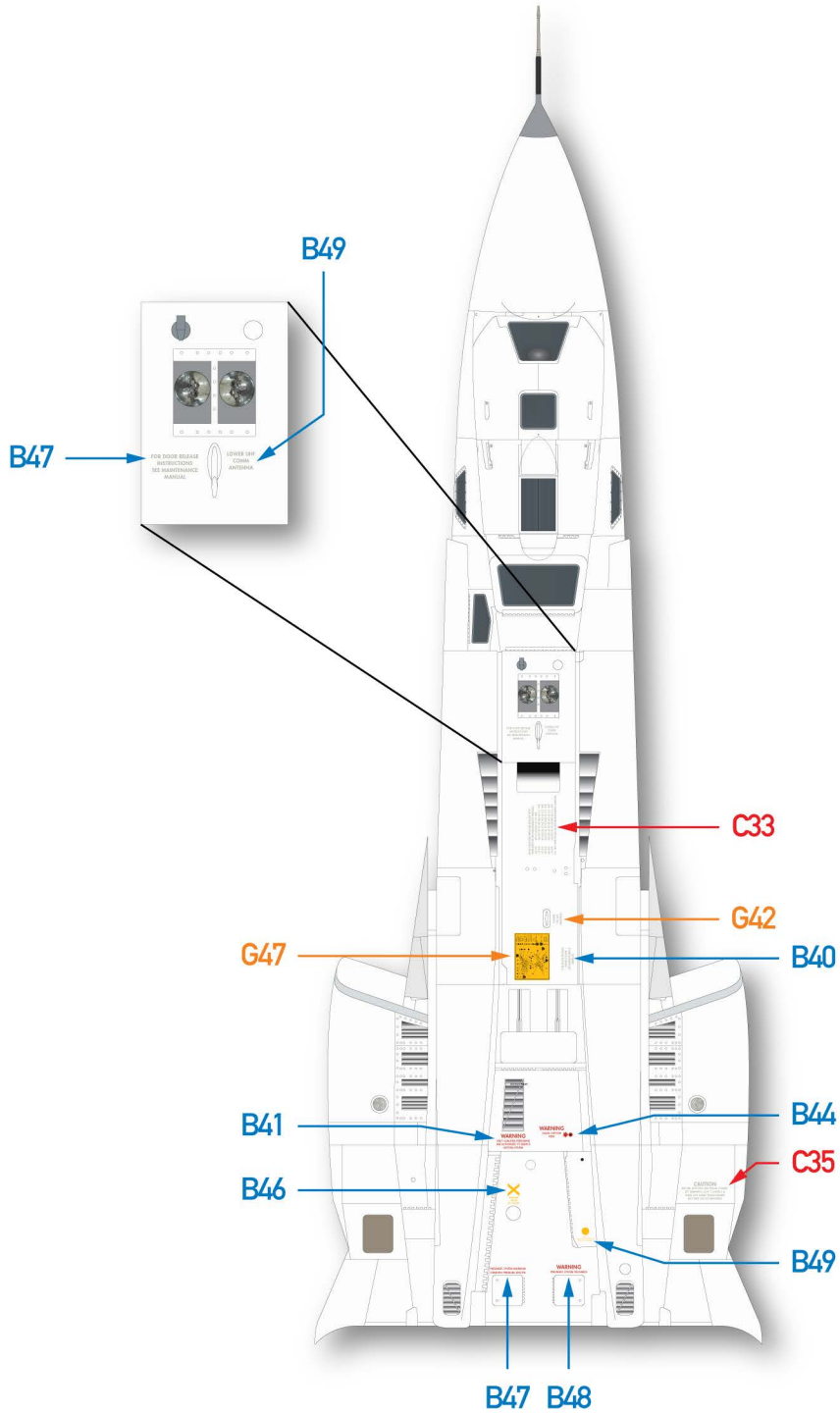

↑
Forward

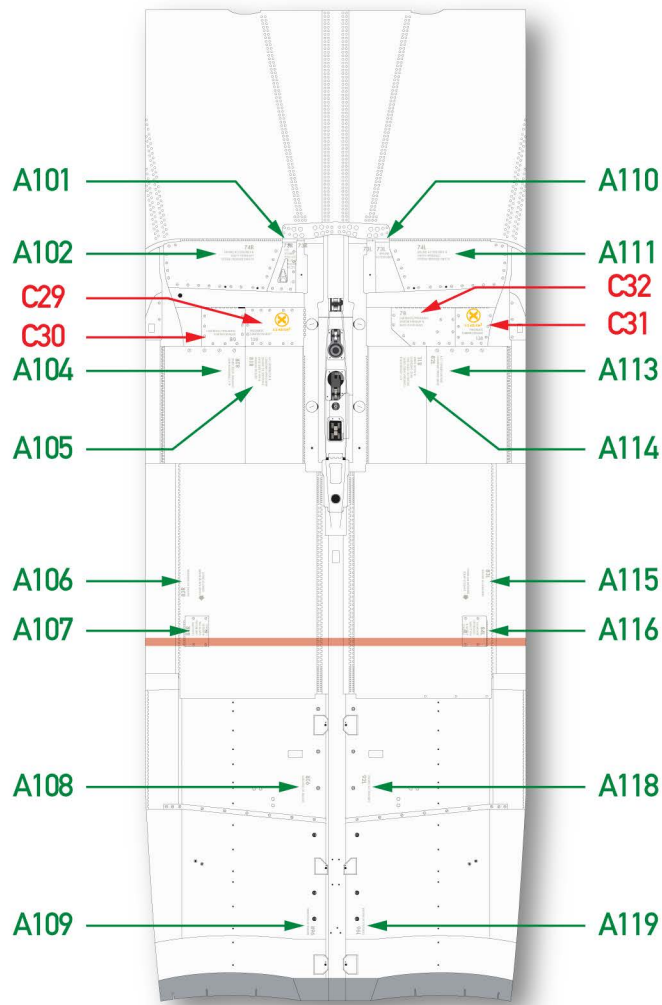

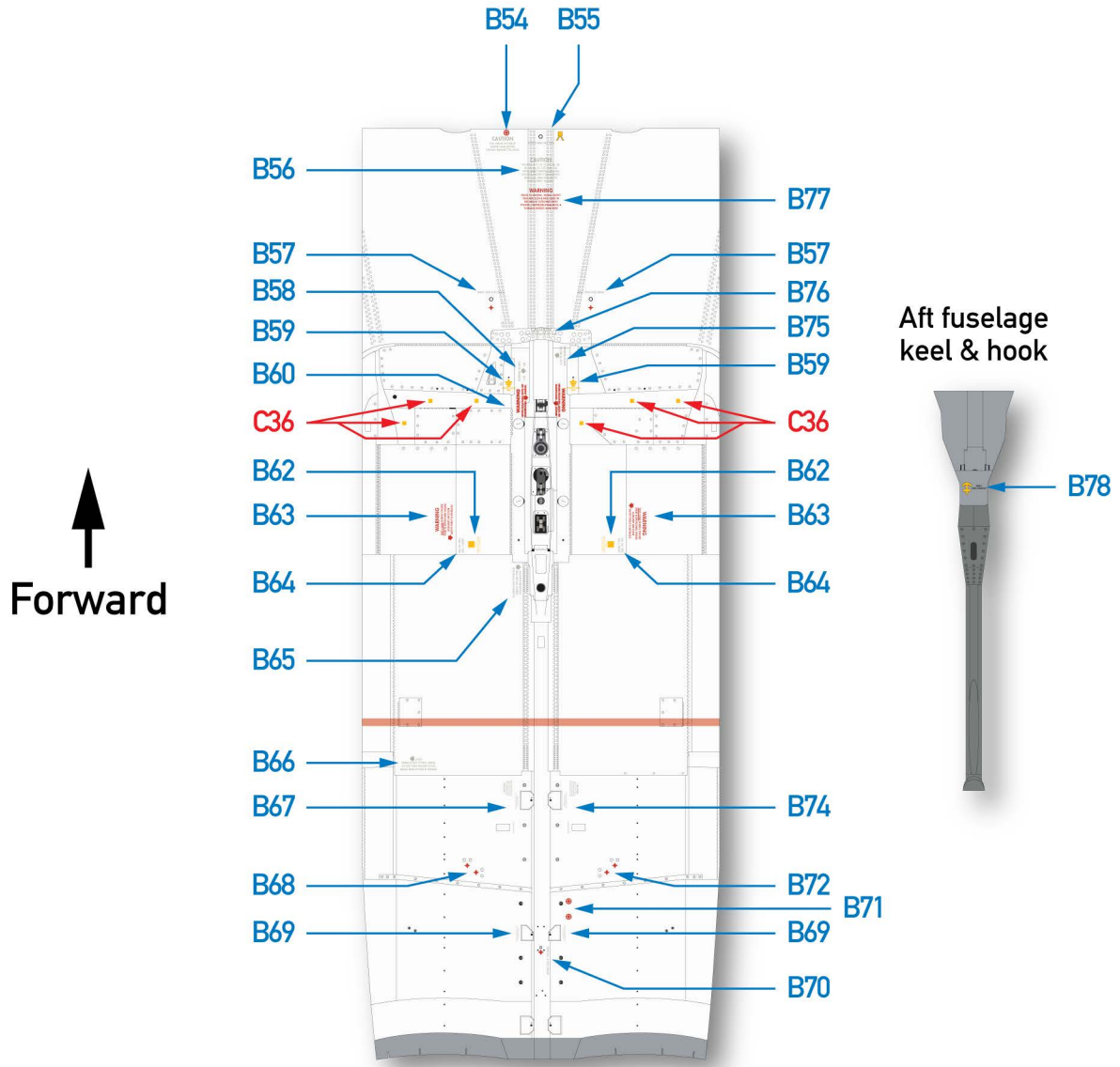

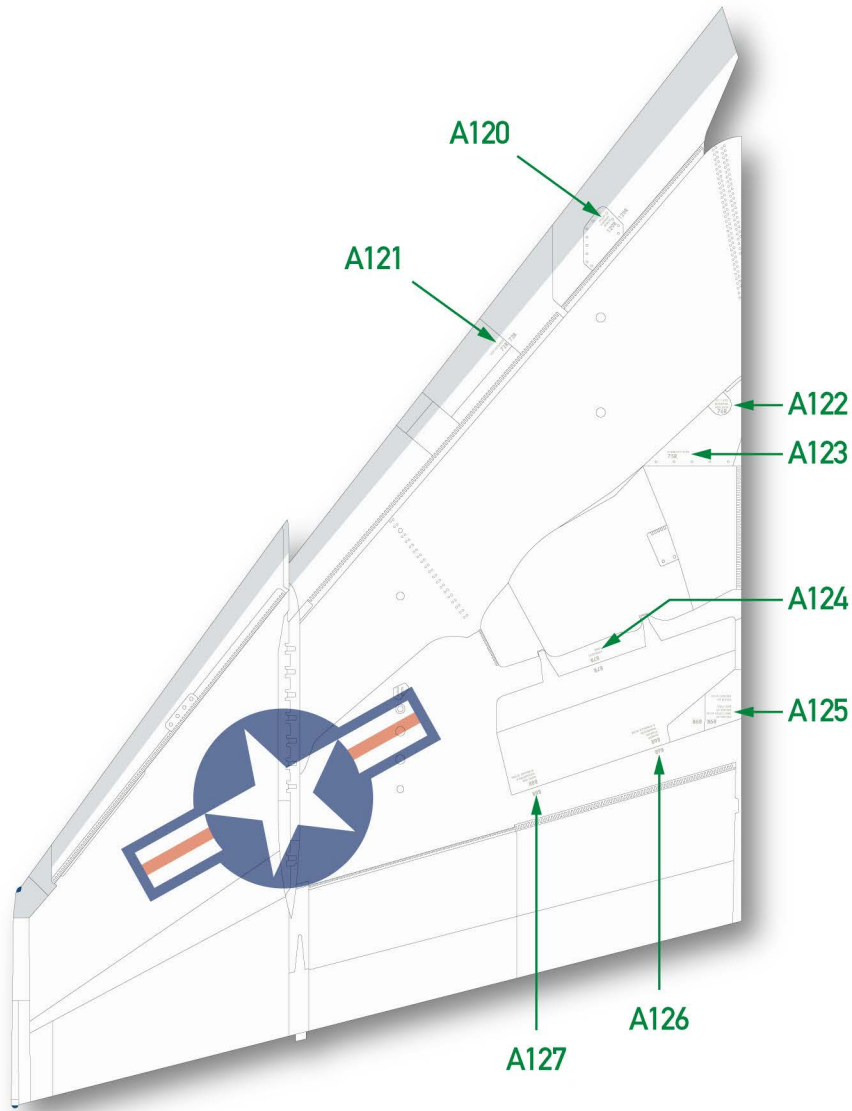

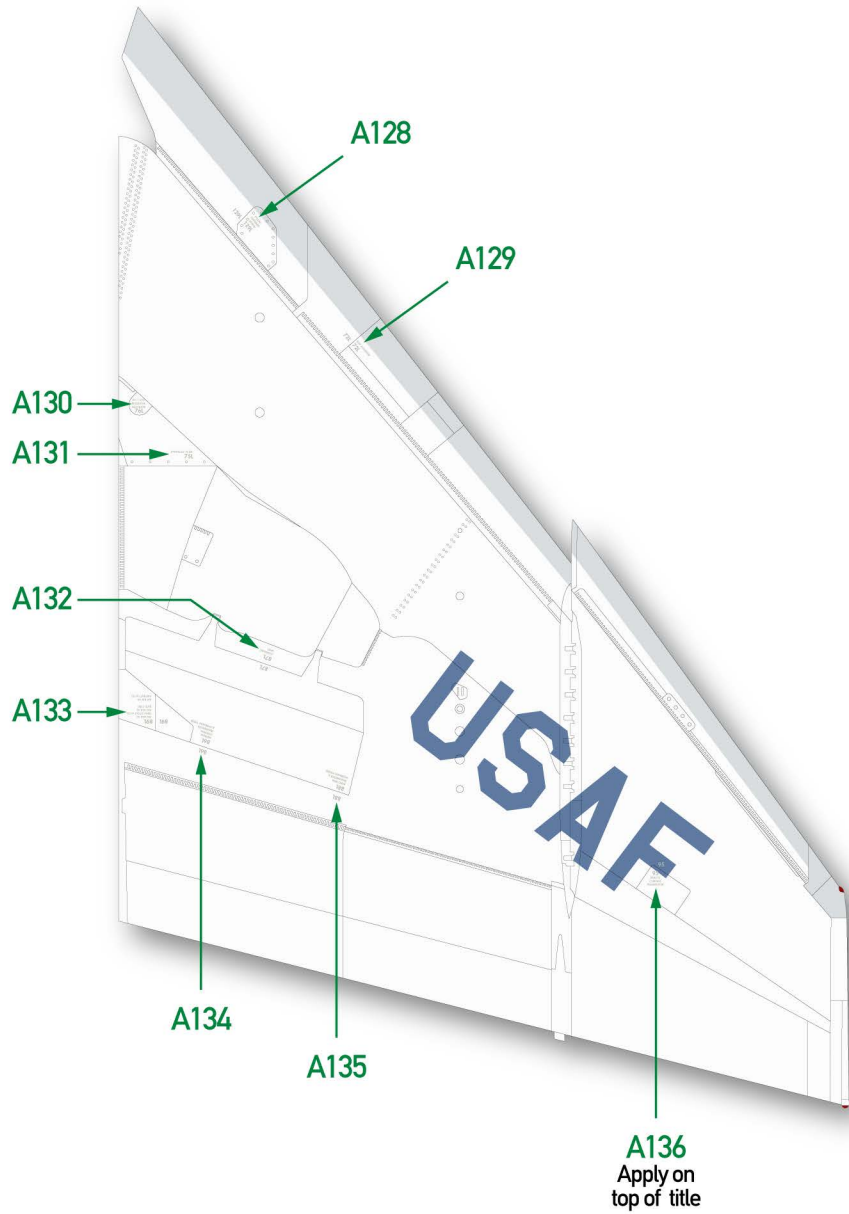

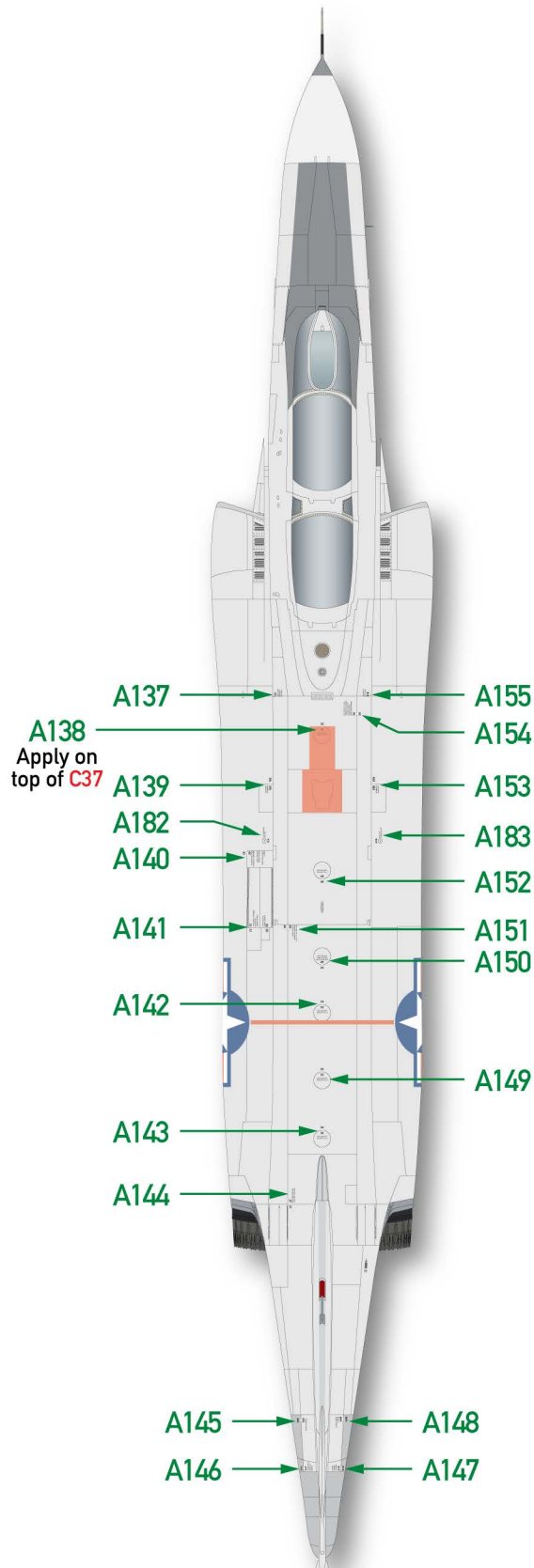

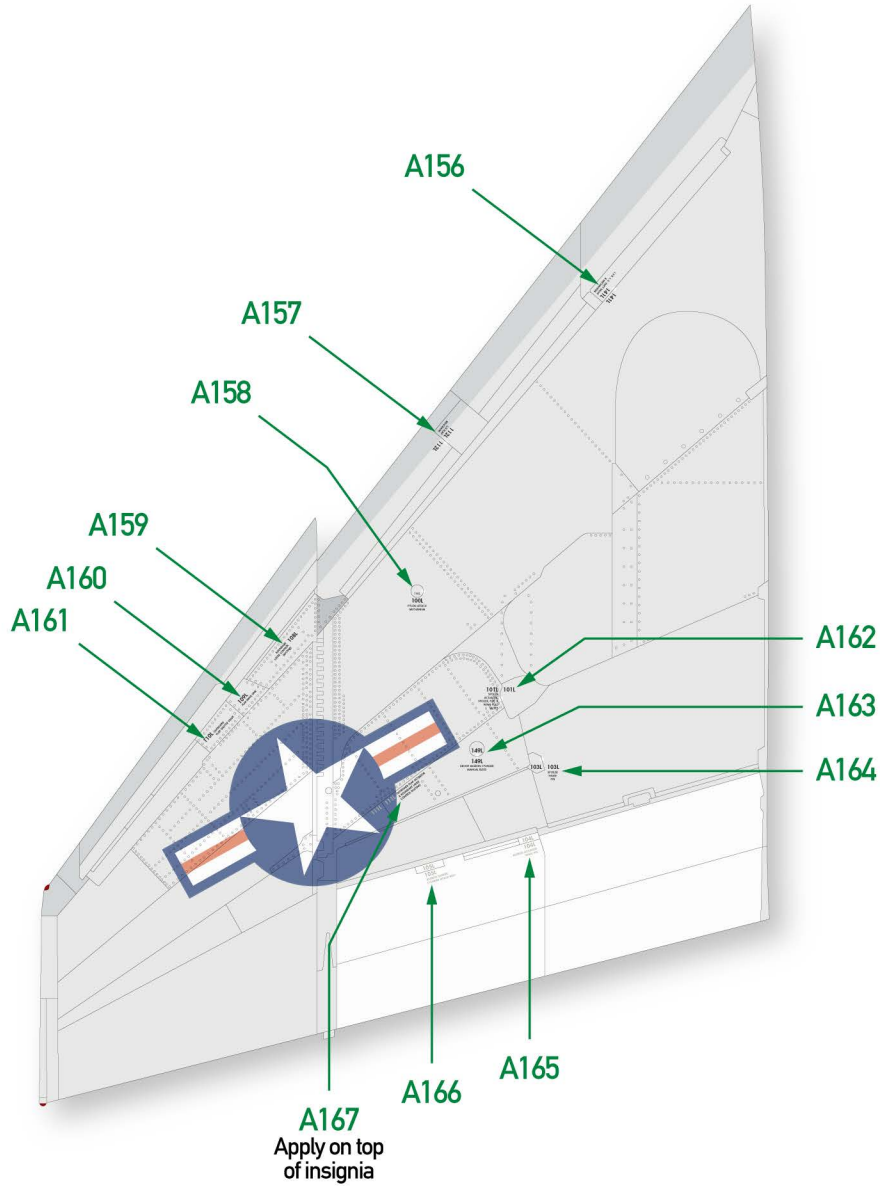

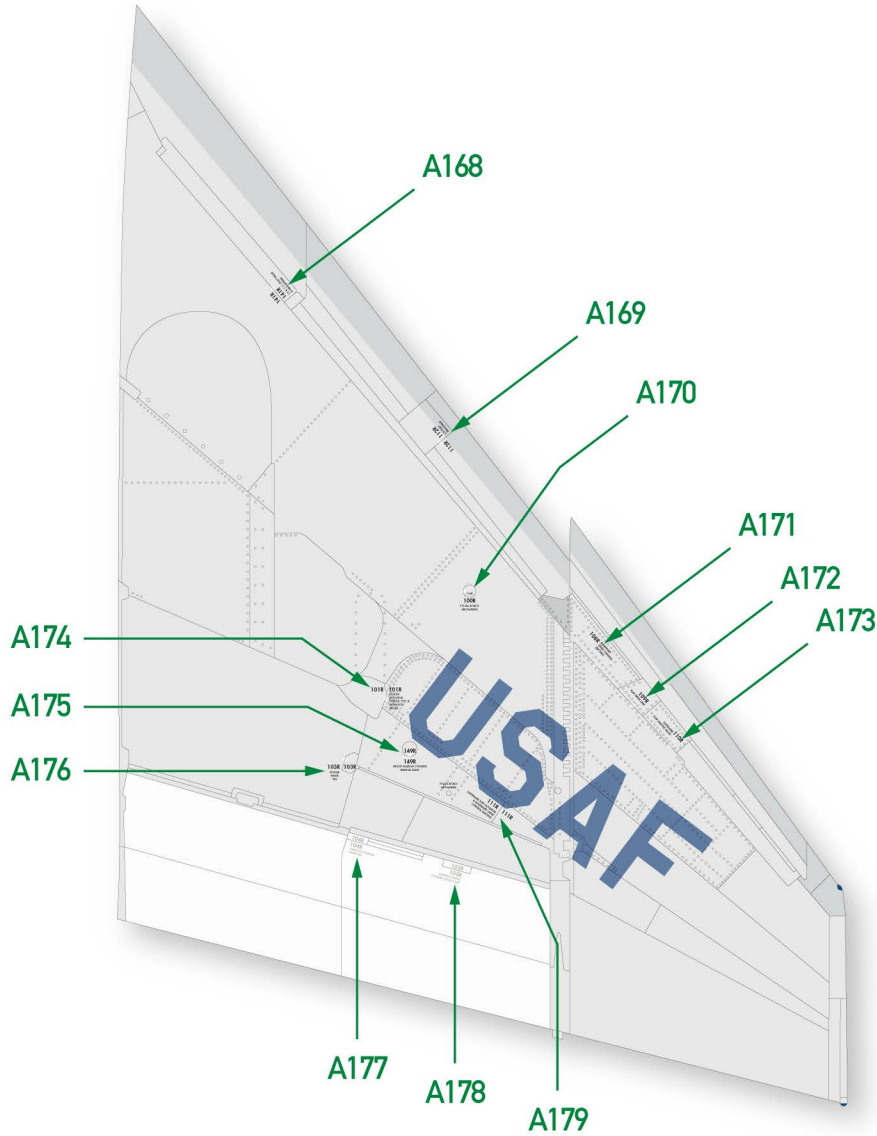

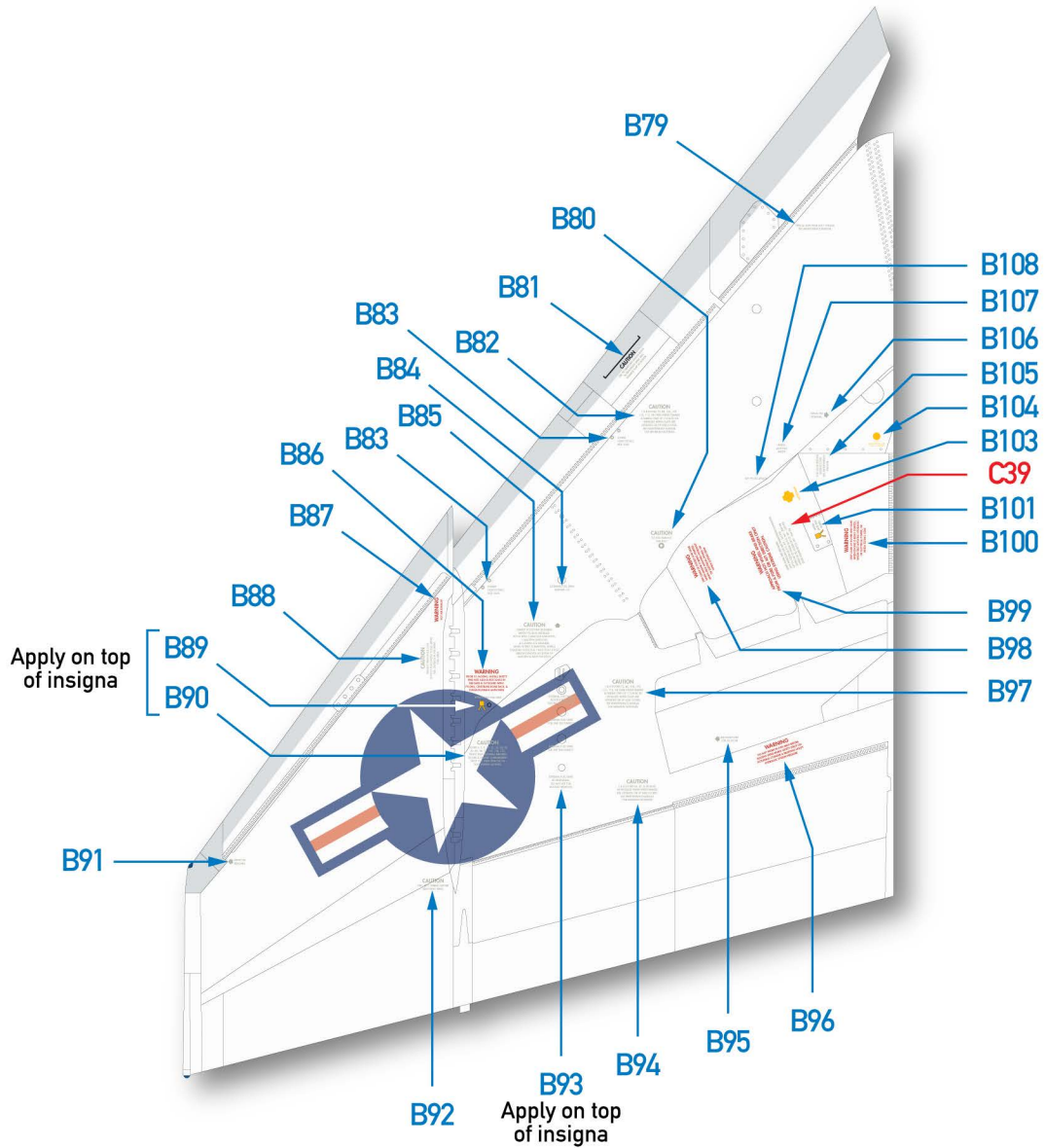

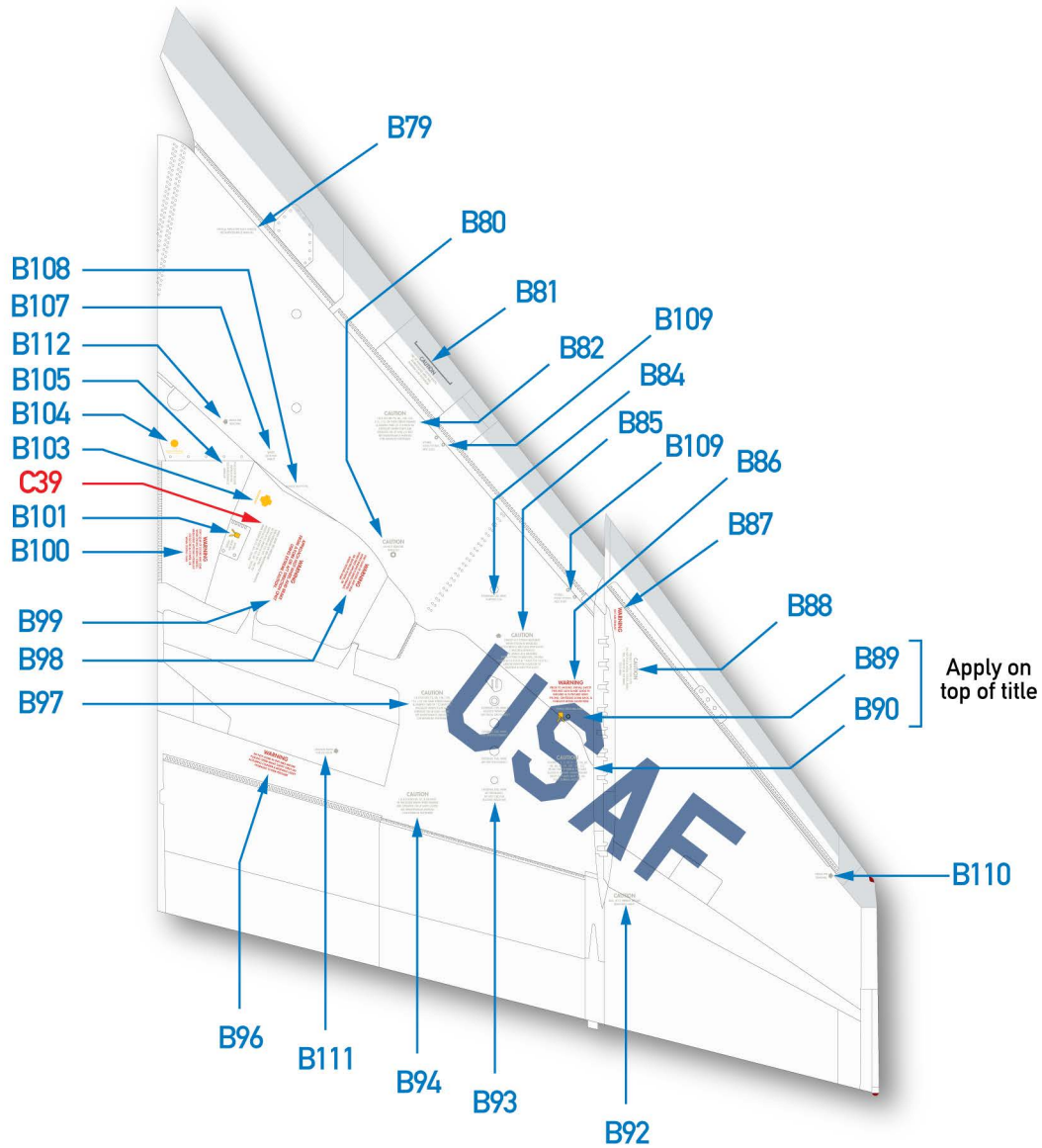

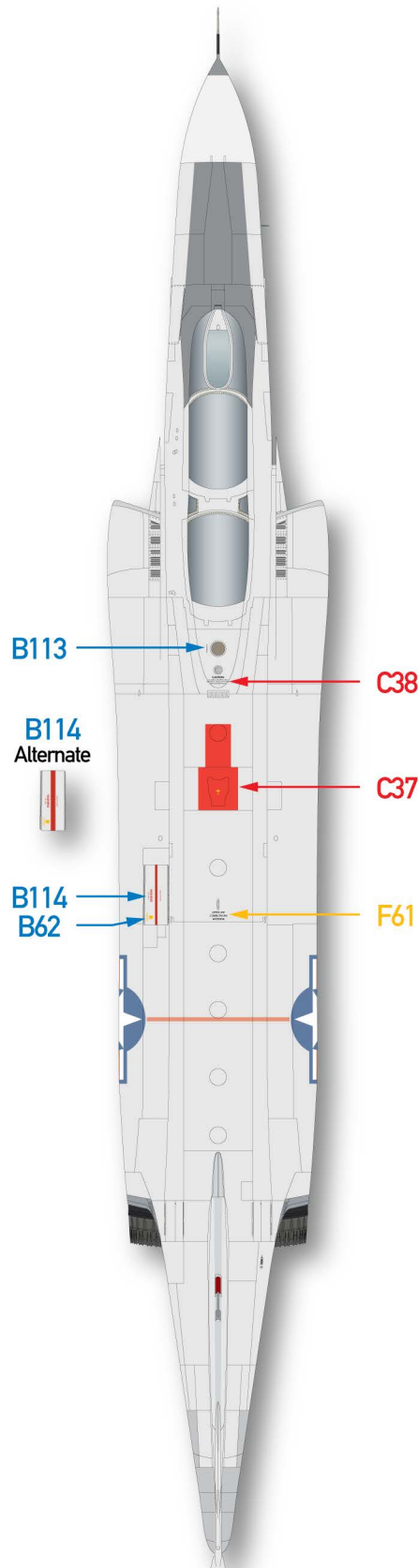

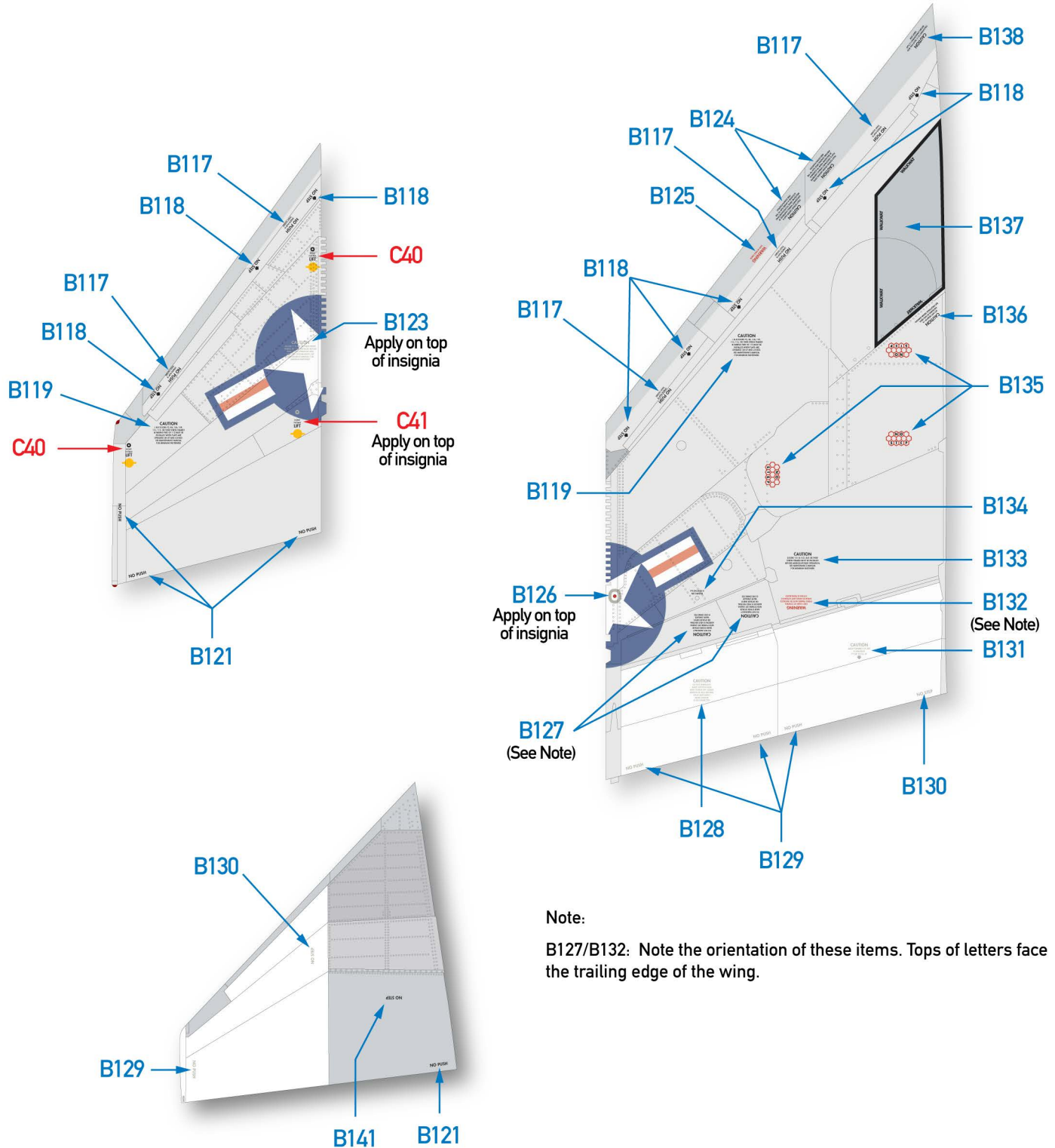

Note:

B127/B132: Note the orientation of these items. Tops of letters face the trailing edge of the wing.

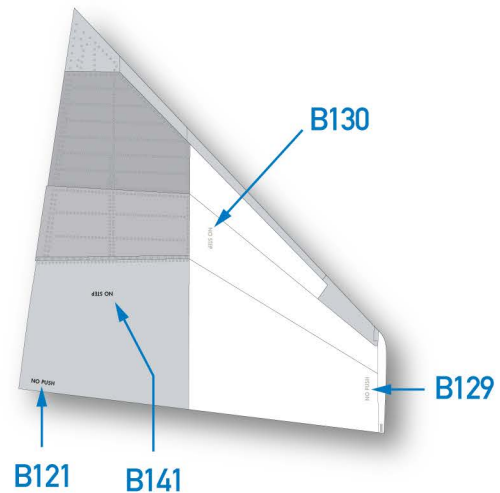
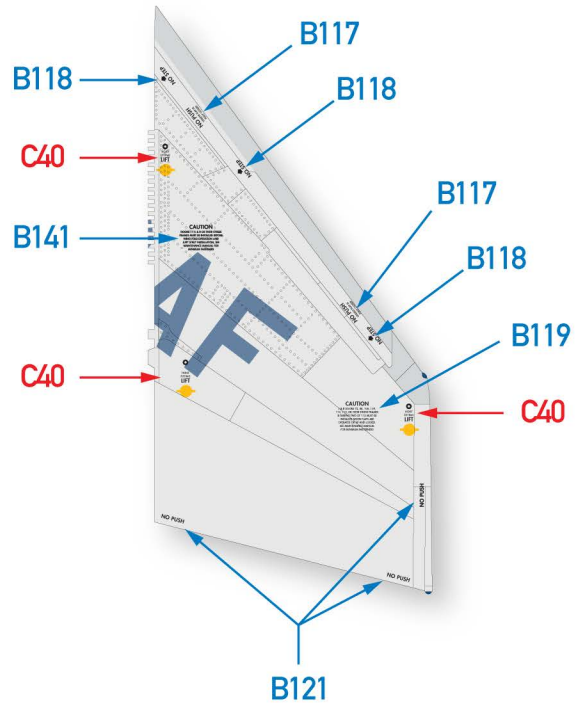
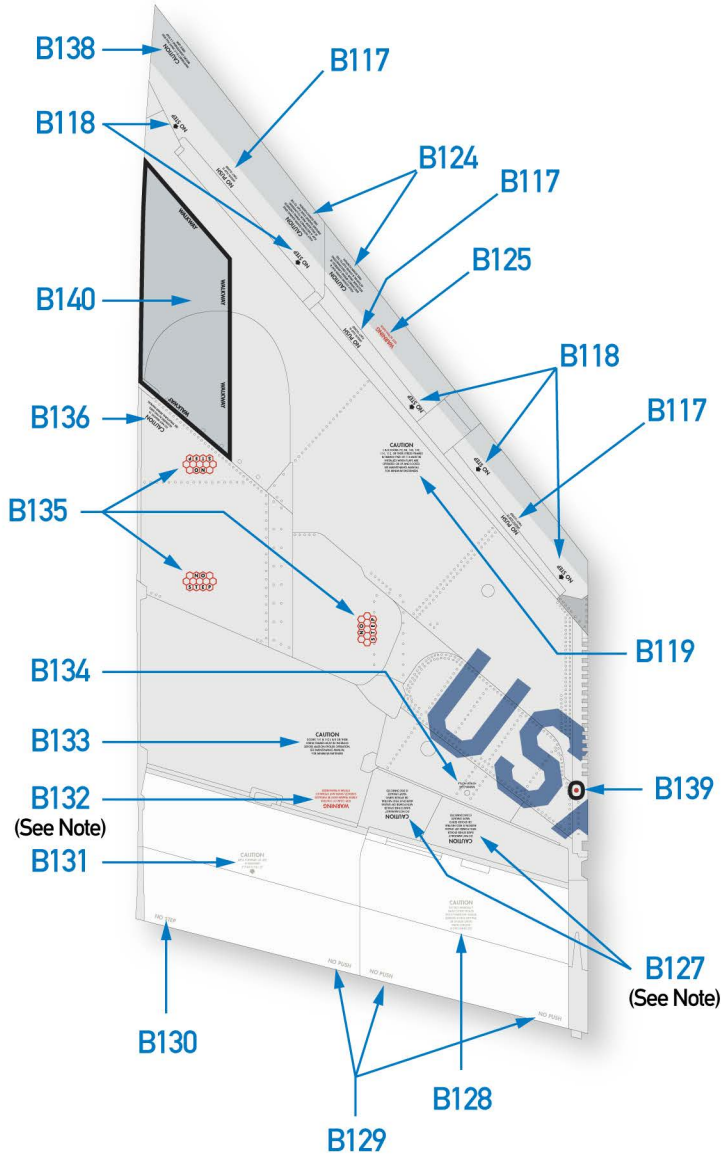

Note:

B127/B132: Note the orientation of these items. Tops of letters face the trailing edge of the wing.

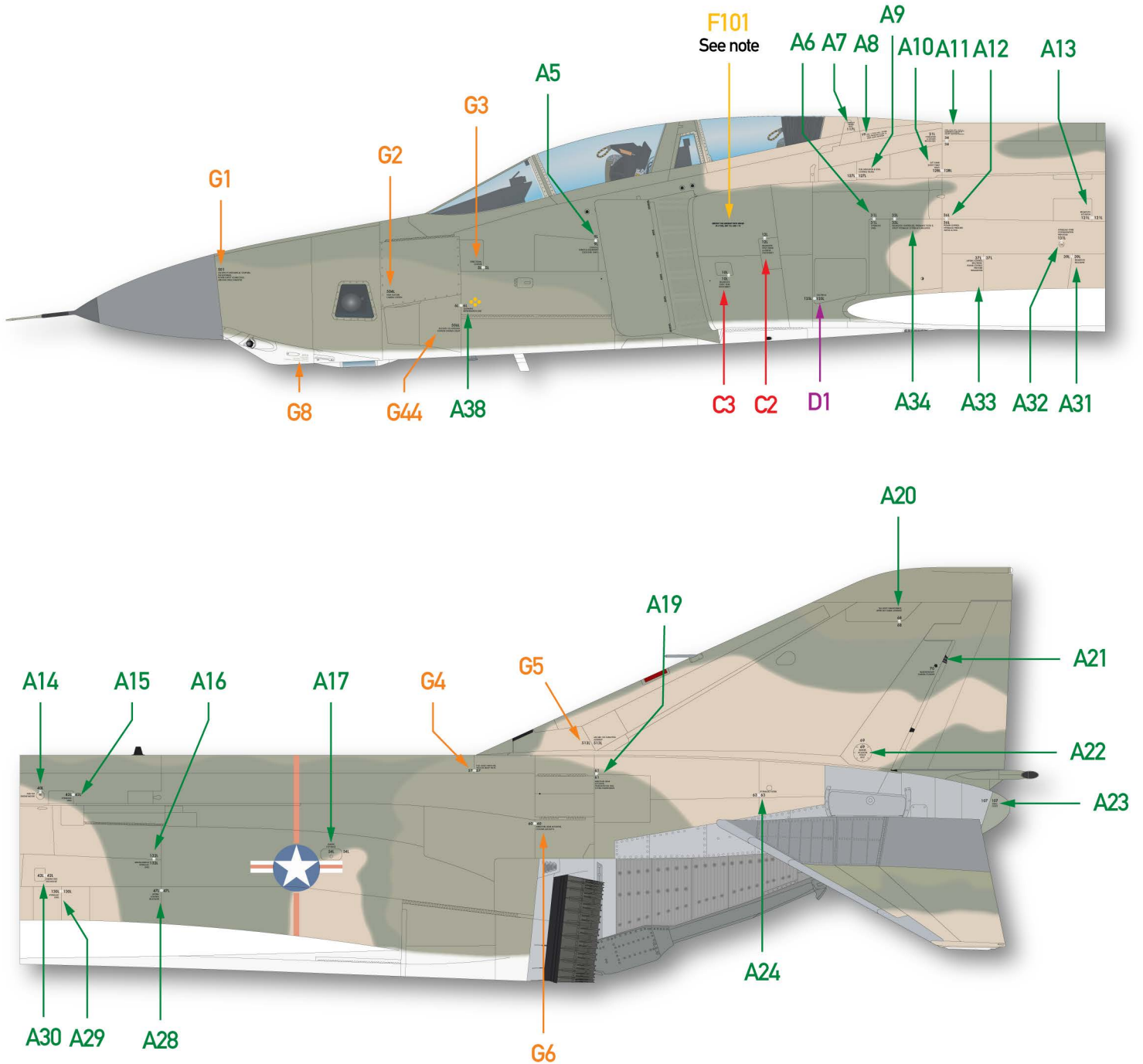

Notes:

Stencils applied to export RF-4Es (for customers other than the Bundesluftwaffe, which used bilingual stencils) were identical to US RF-4Cs, including those with unique camouflage schemes such as Iran and Israel. The only exception was the few late RF-4Es delivered with Ghost Gray camouflage, which are not covered here.

F101: This portion of the standard aircraft data block was applied on export aircraft. On USAF aircraft, there were two lines above it giving the production block number and USAF serial.

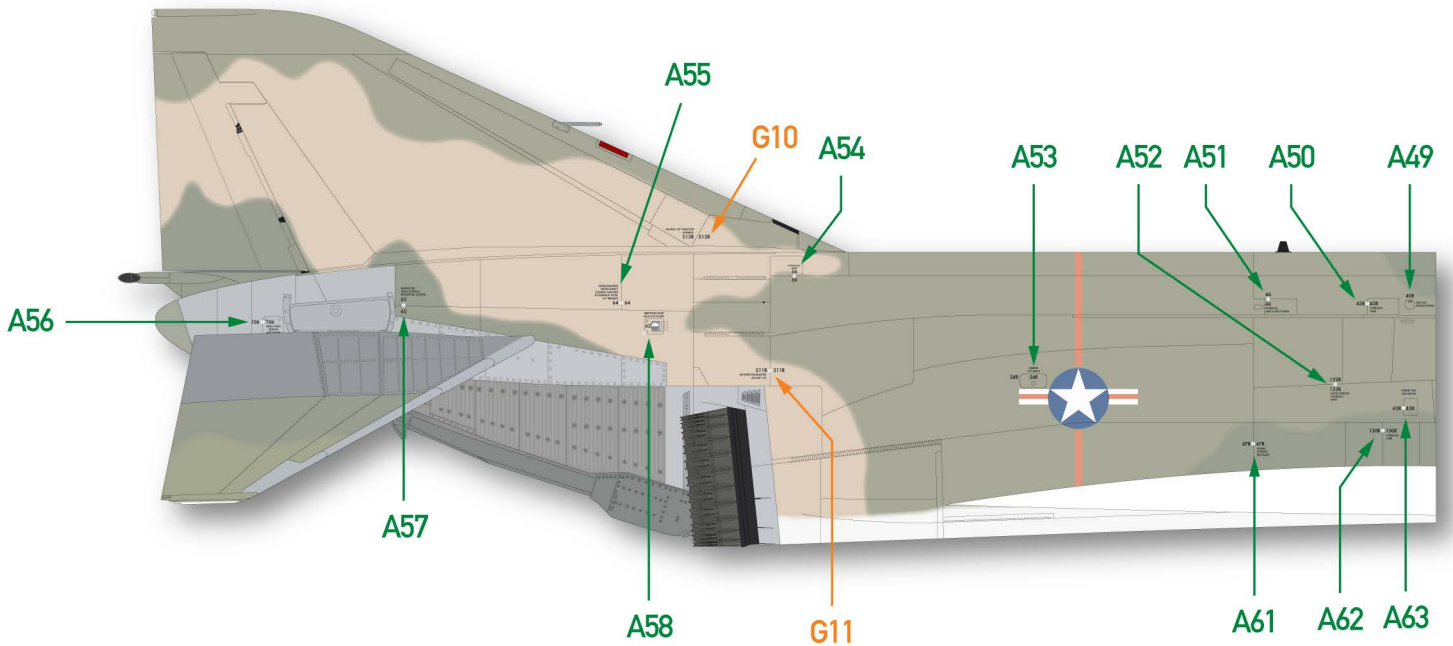
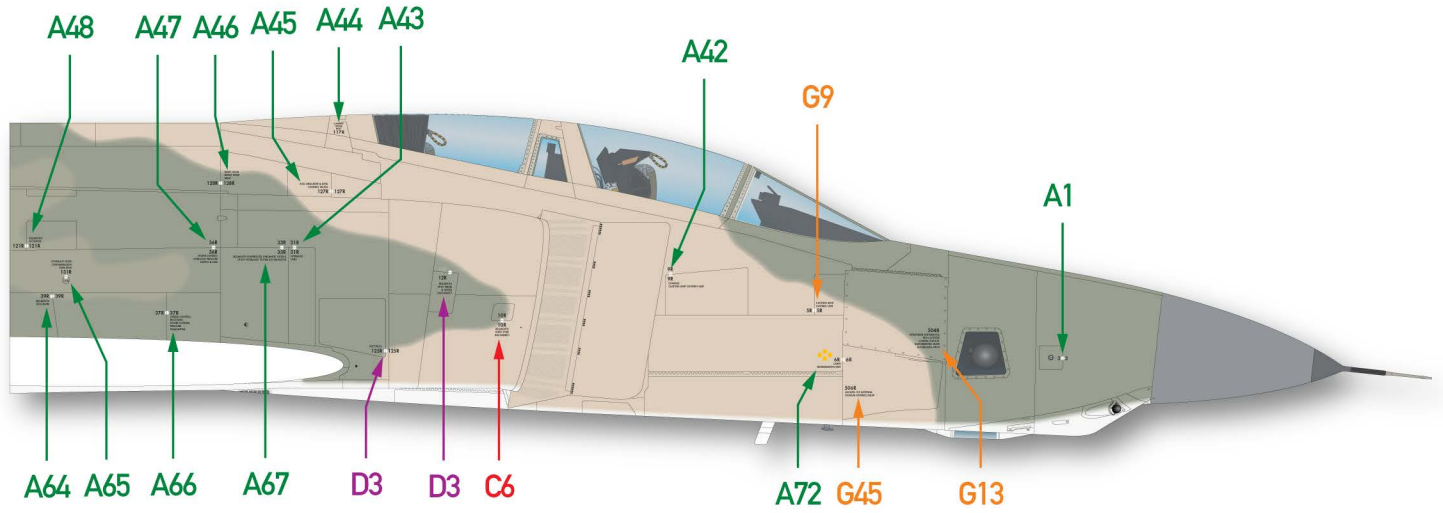

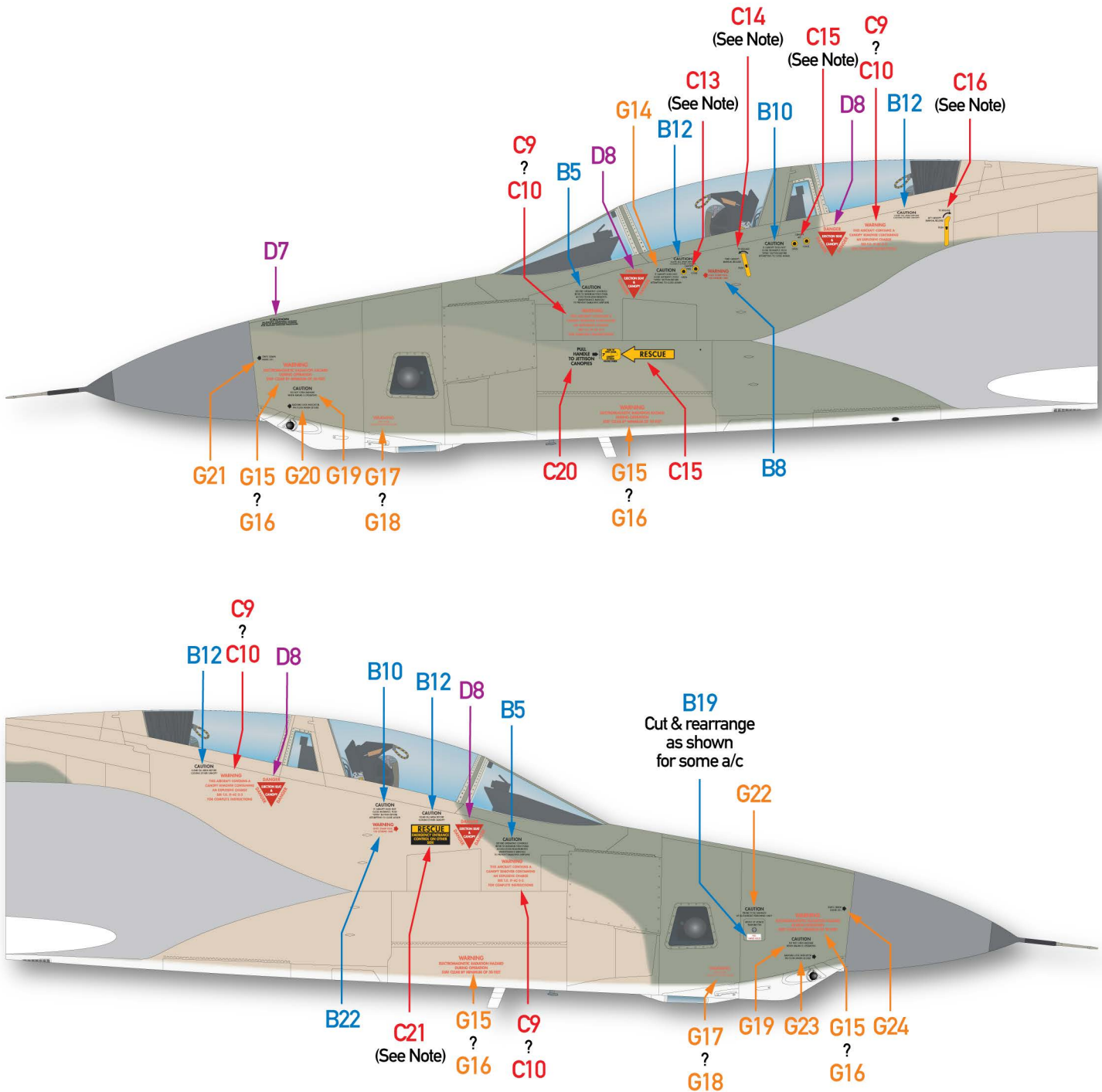

Notes:

C9/C10, G15/G16: The salmon colored stencils (C9/G15) were most commonly used, but the bright red versions (C10/G16) were also applied on some aircraft.

C13 - C16: Canopy open/close buttons & handles are provided to fit the ZM and Tamiya kit scribing (as closely as can make them), as well as in the actual scale size and shape based on tracings and measurements of these items on an actual F-4. The kit scribing (on every existing 1/48 F-4 kit we have found) is not really accurate in size or shape. We recommend filling the scribed detail and using the "B" versions of these decals, which are accurate scale representations of the real thing.

C21: Two variations are provided. The one shown in the drawing is by far the most common.

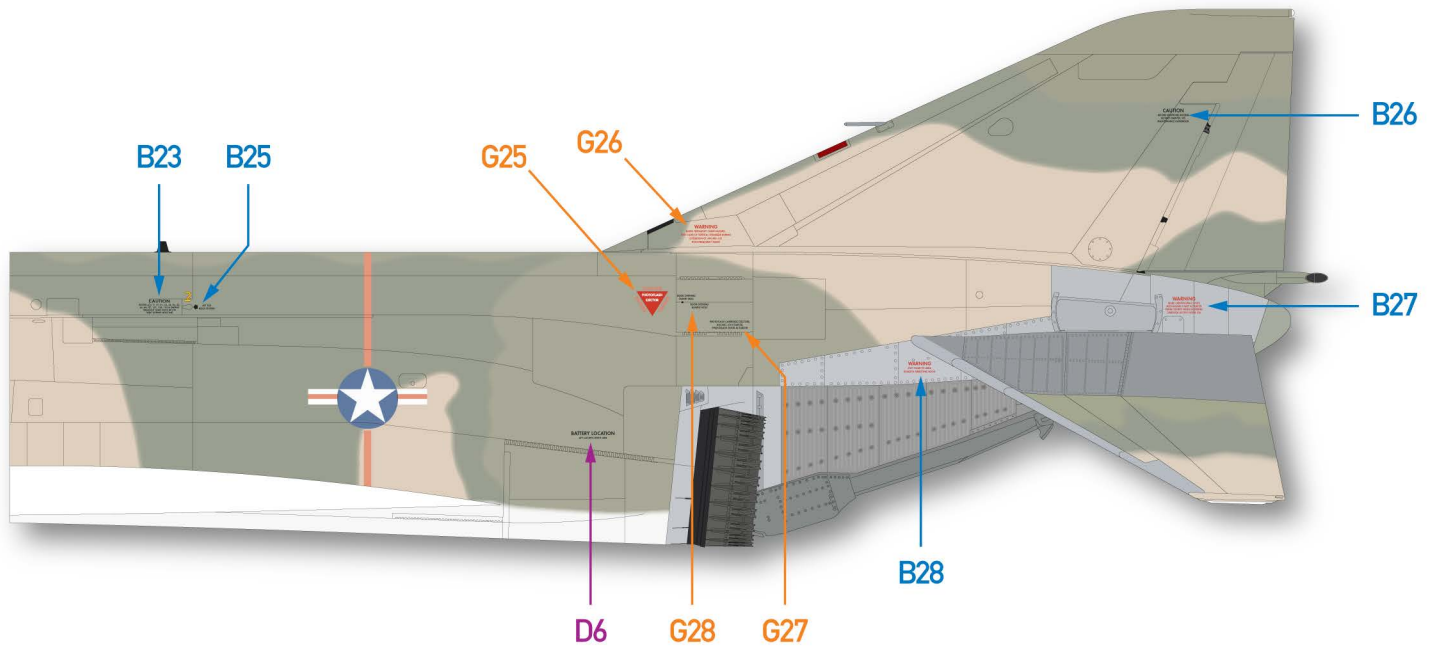
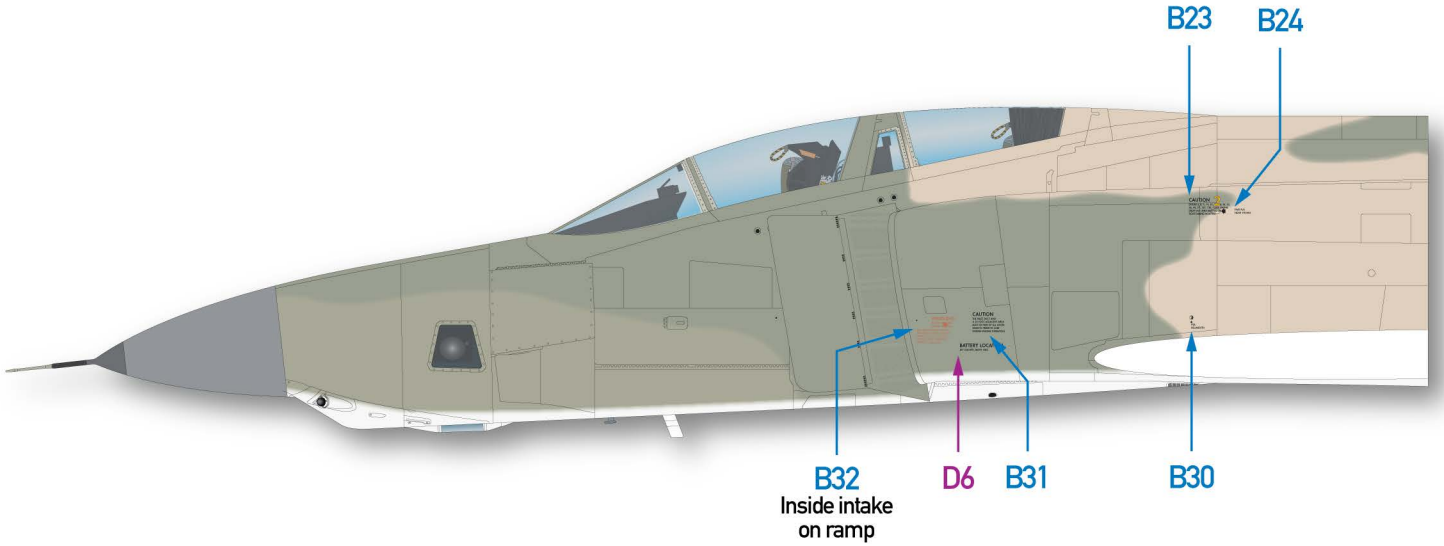

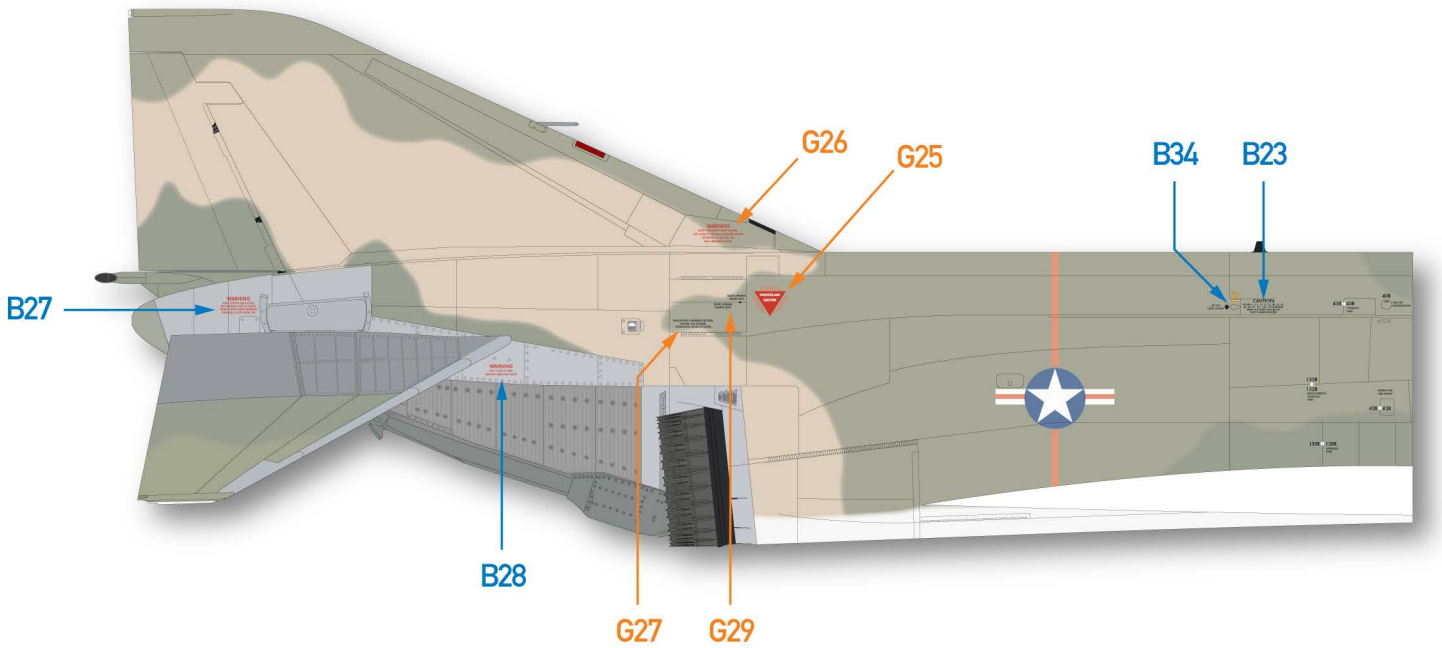
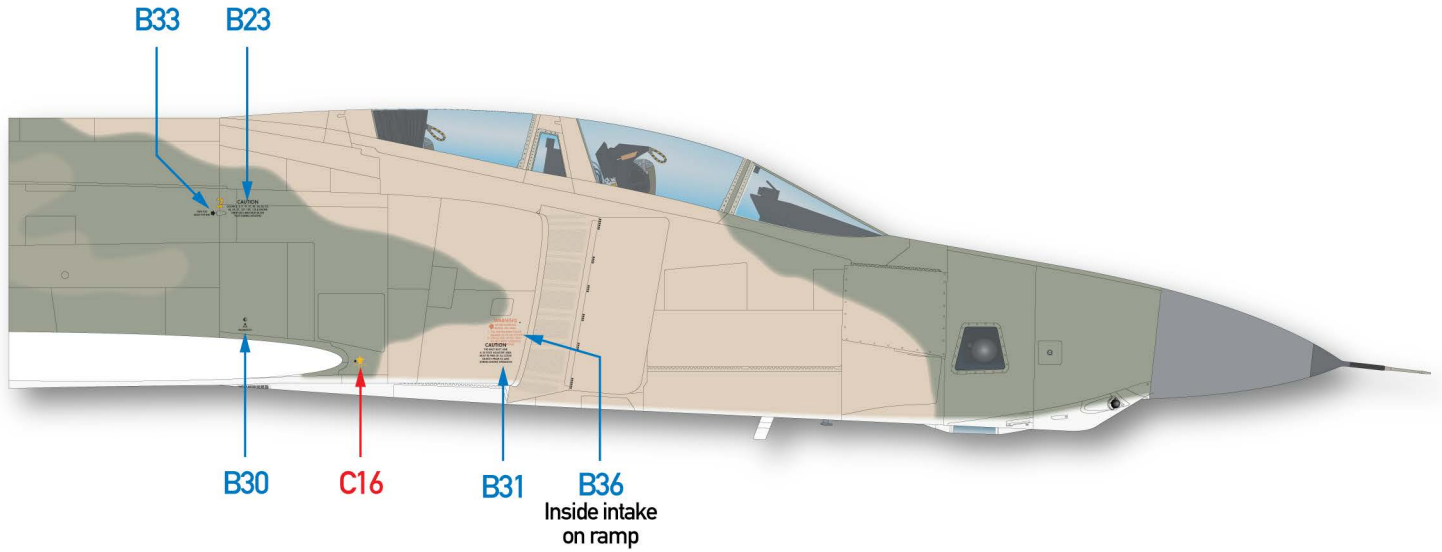

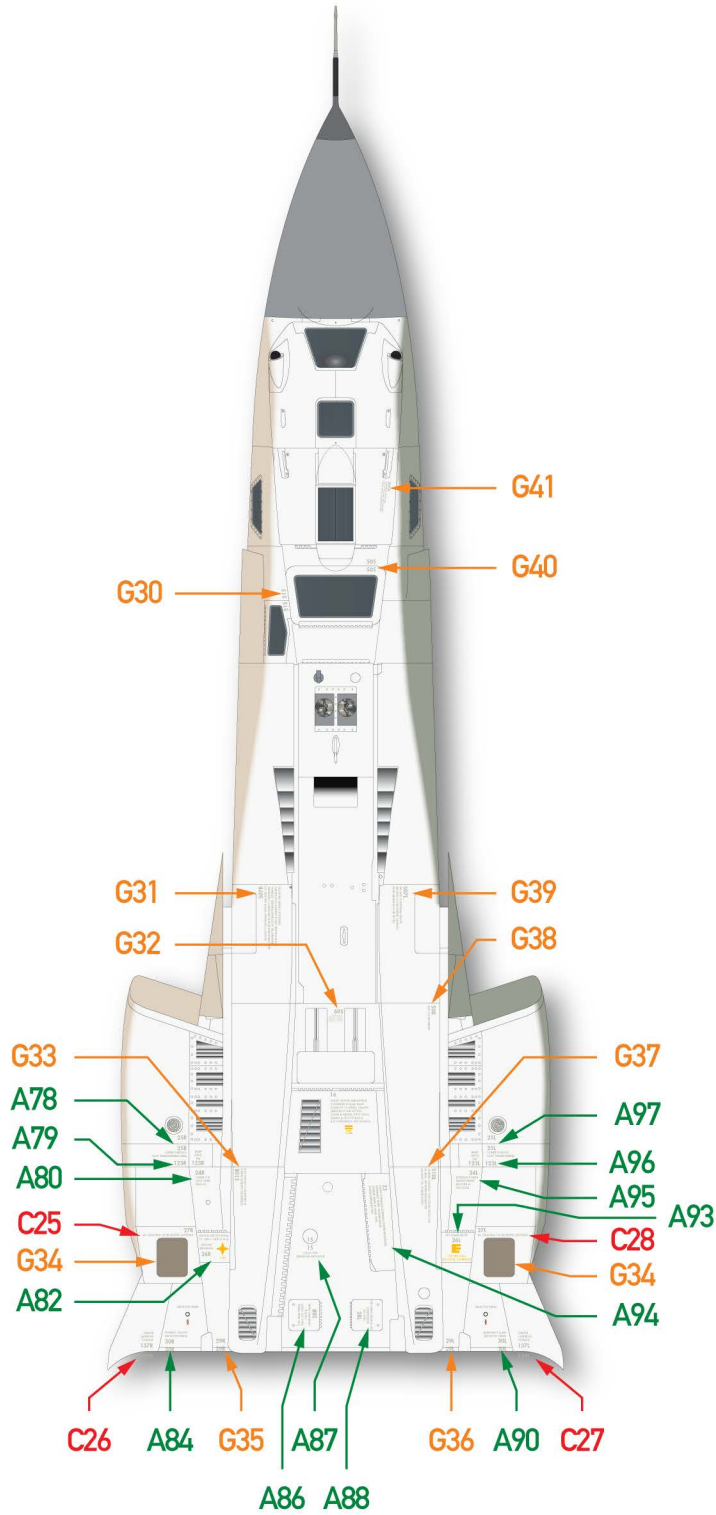

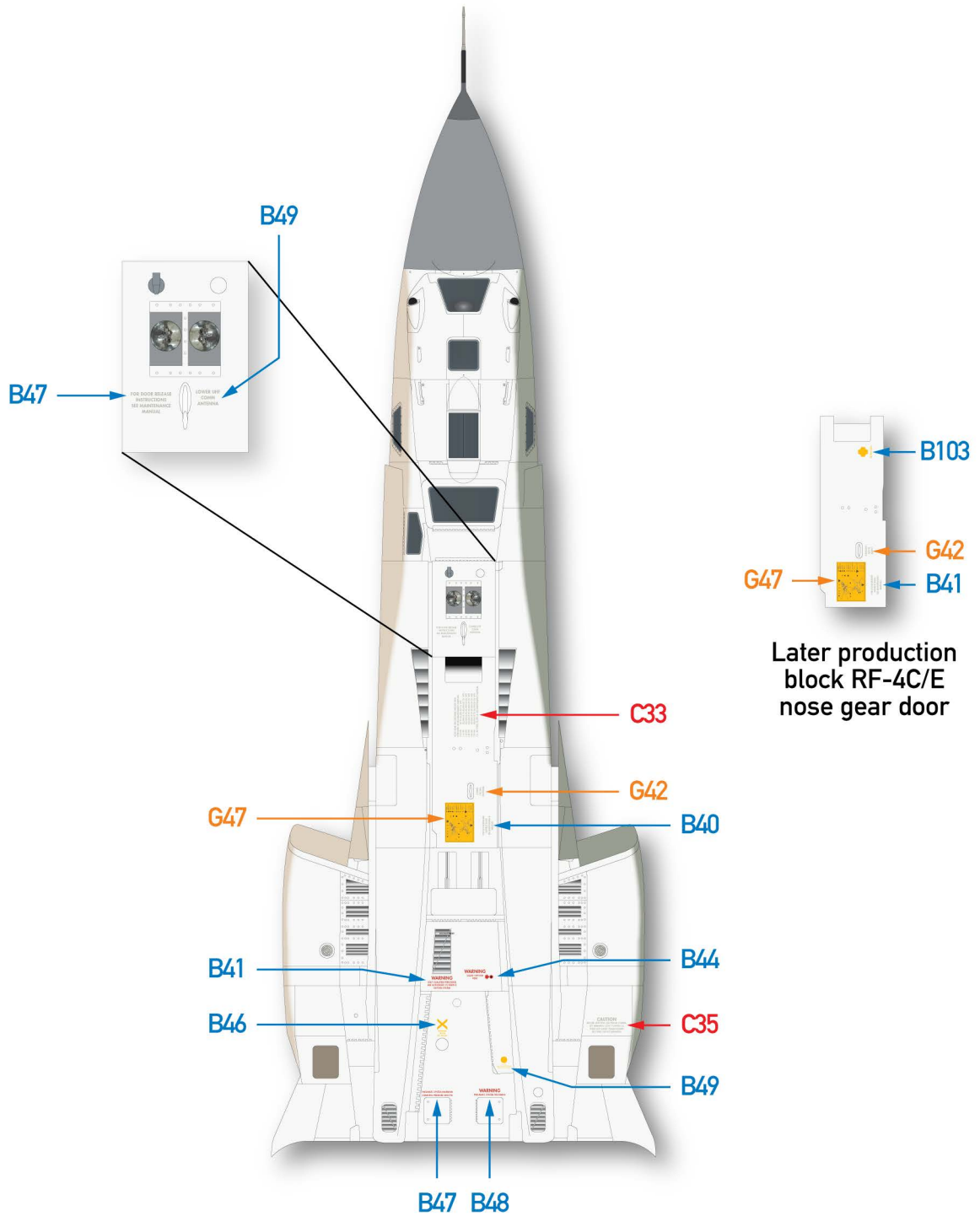

↑
Forward

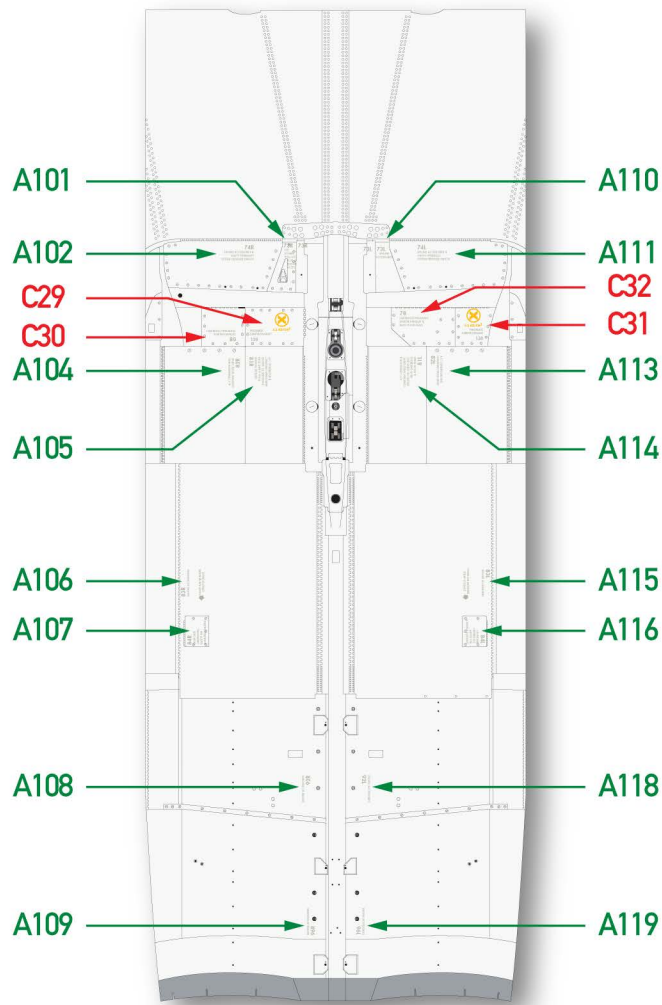

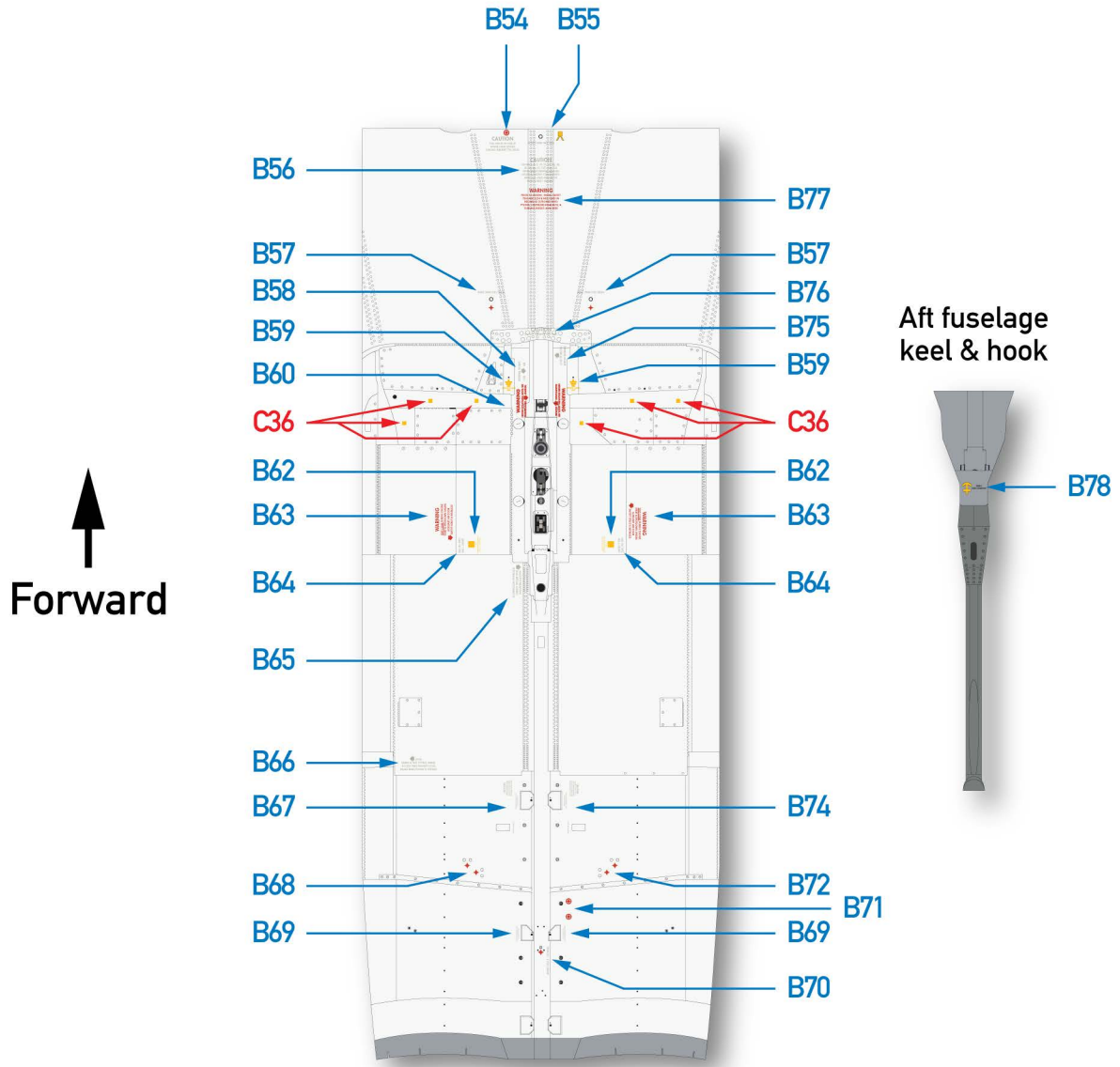

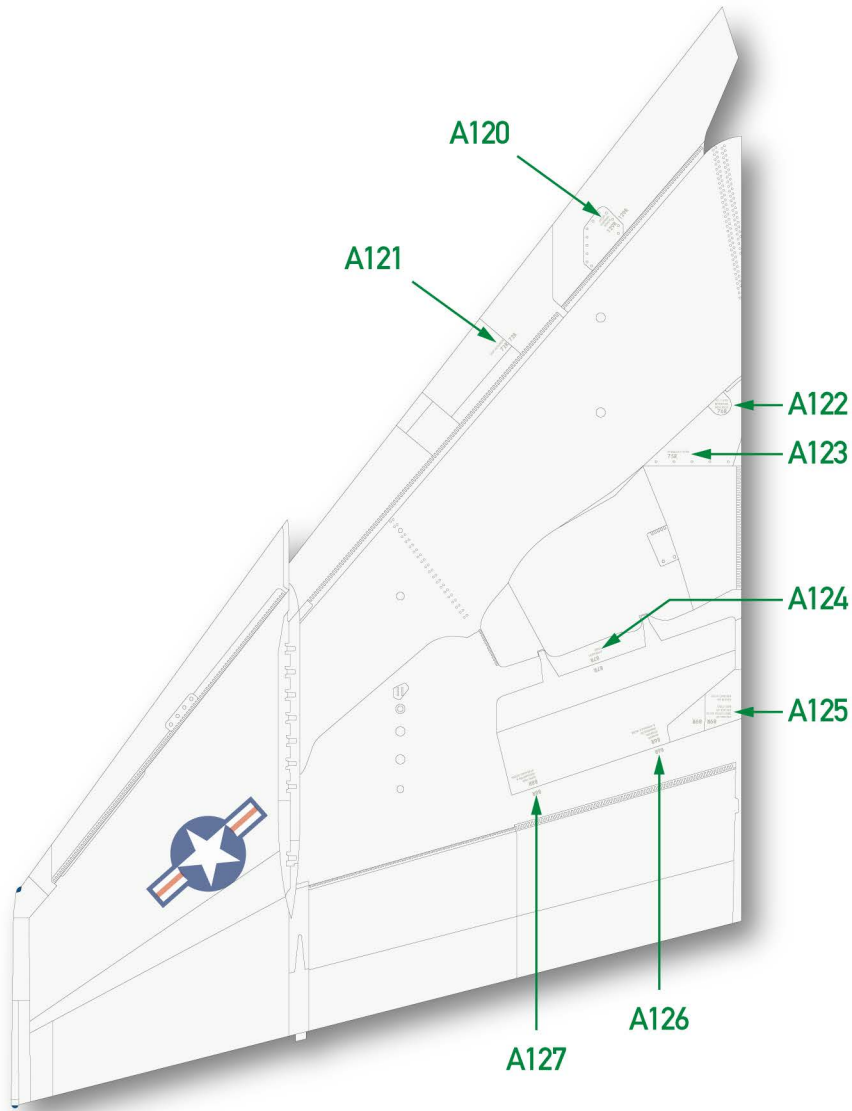

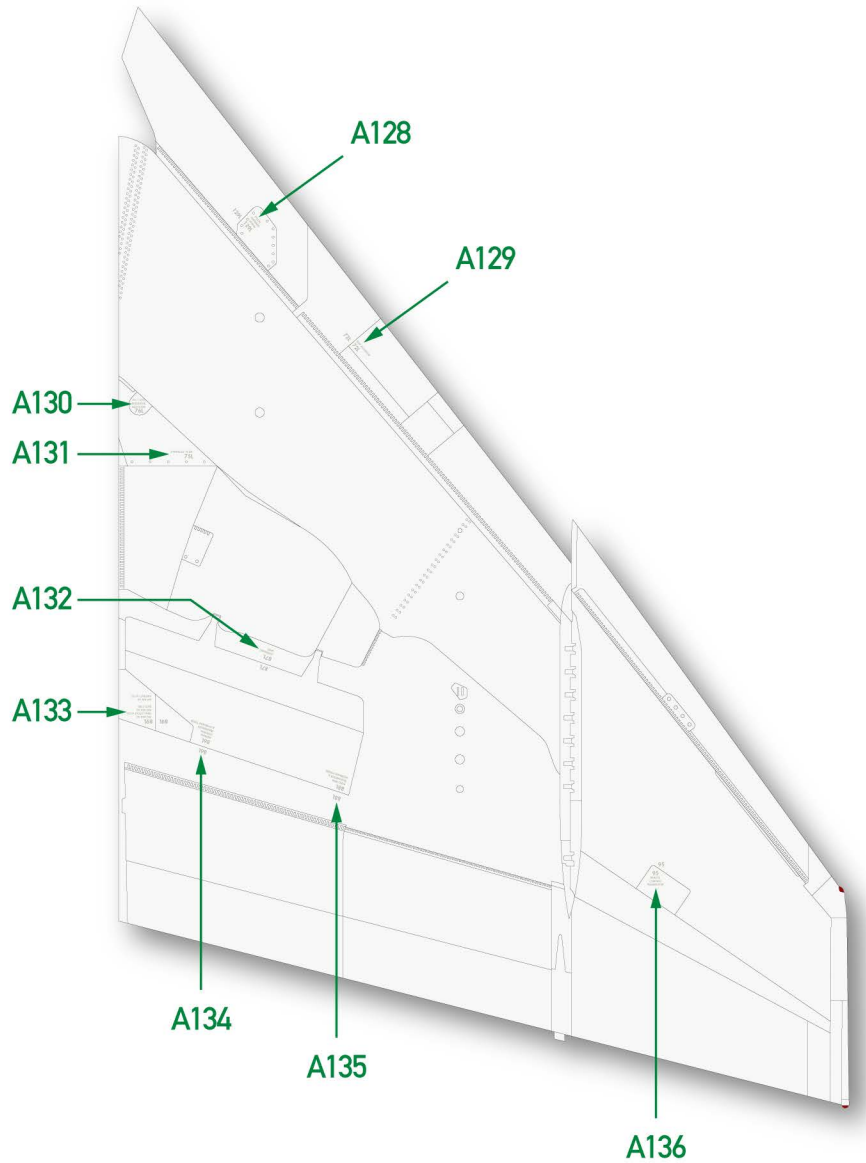

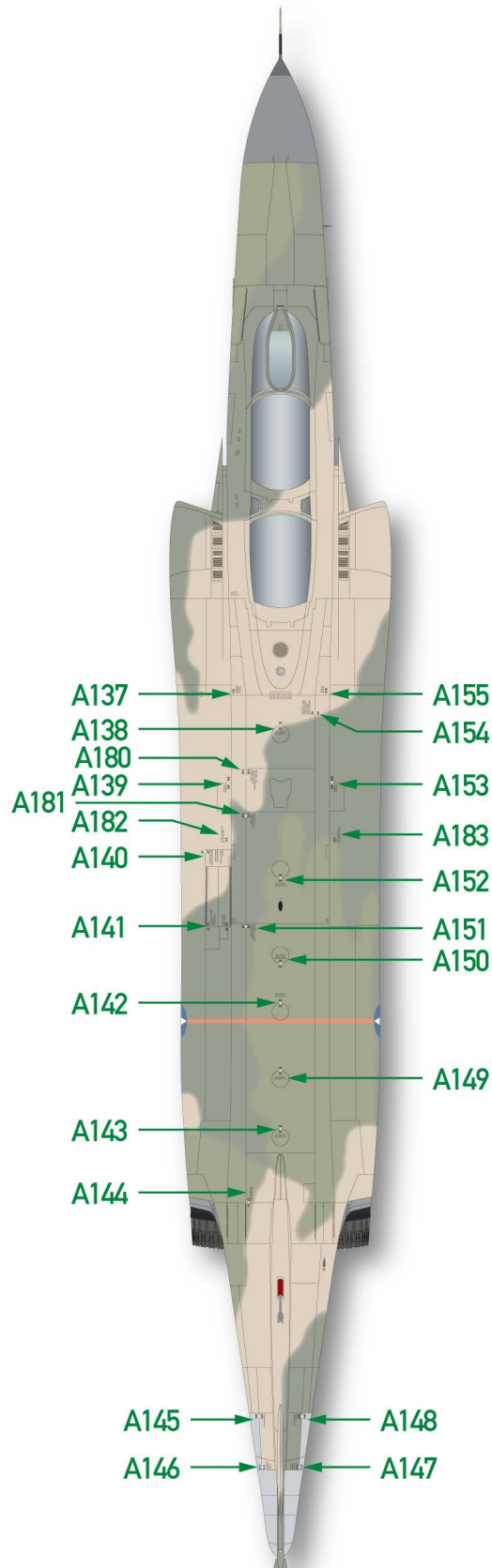

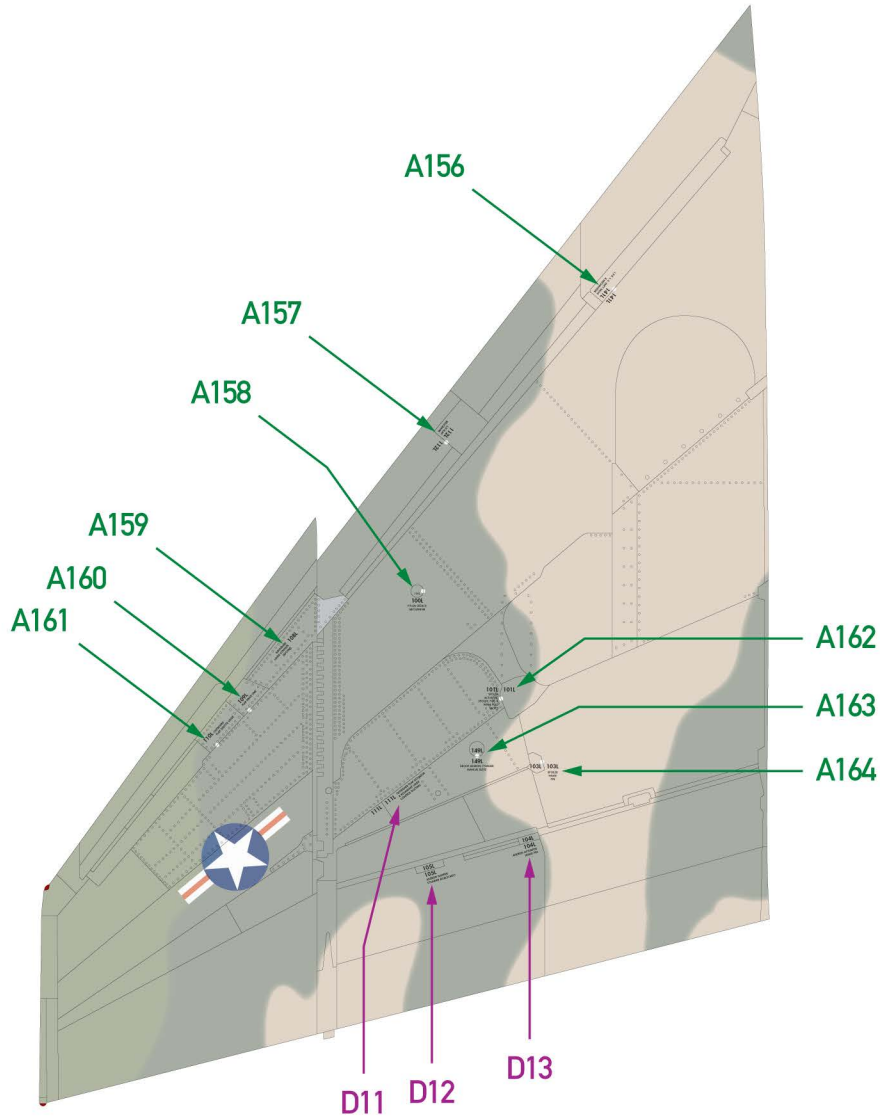

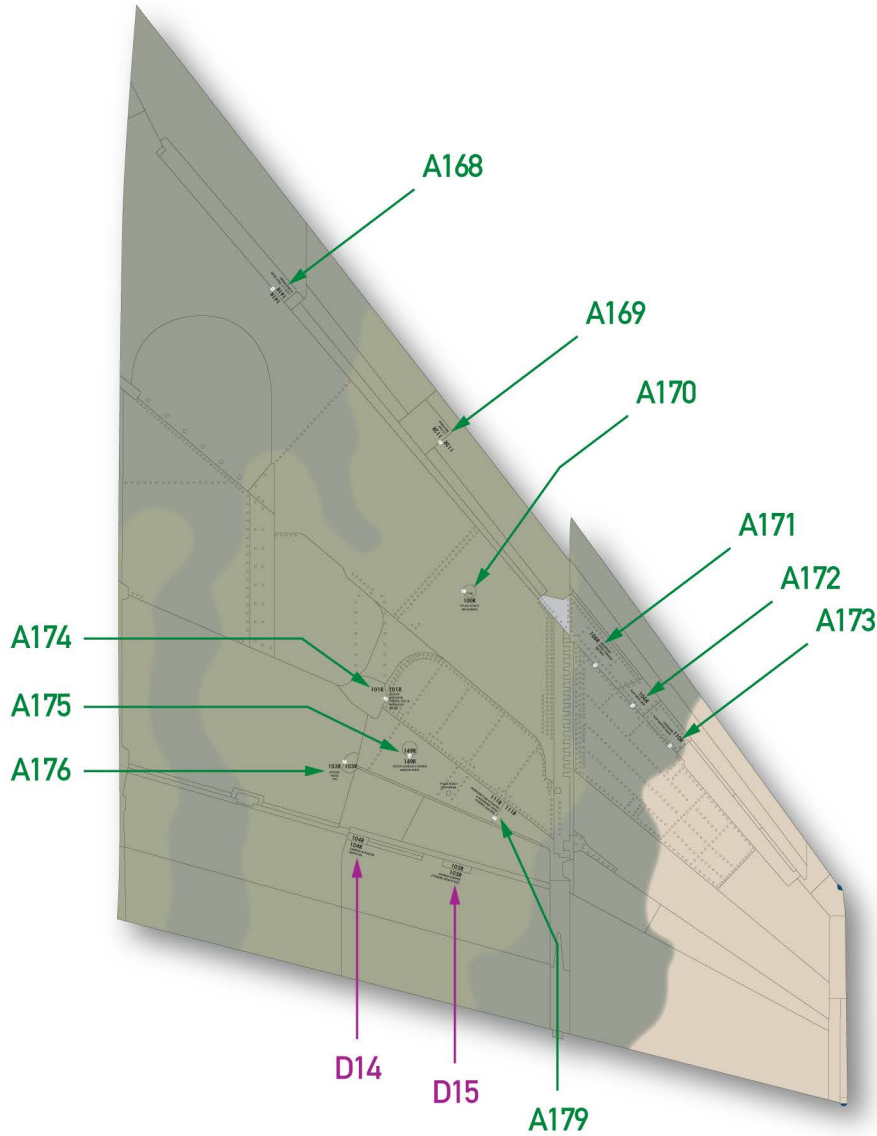

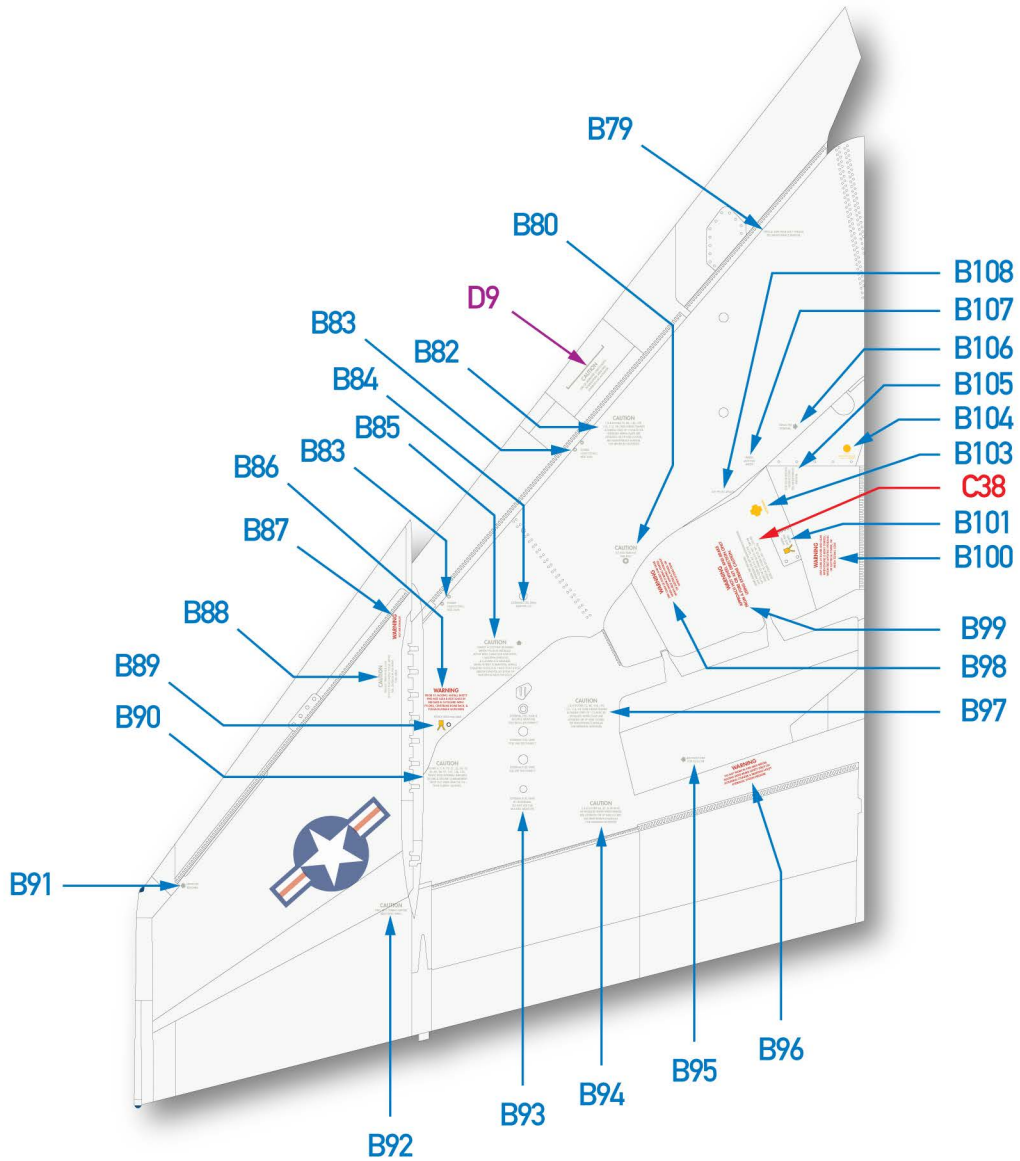

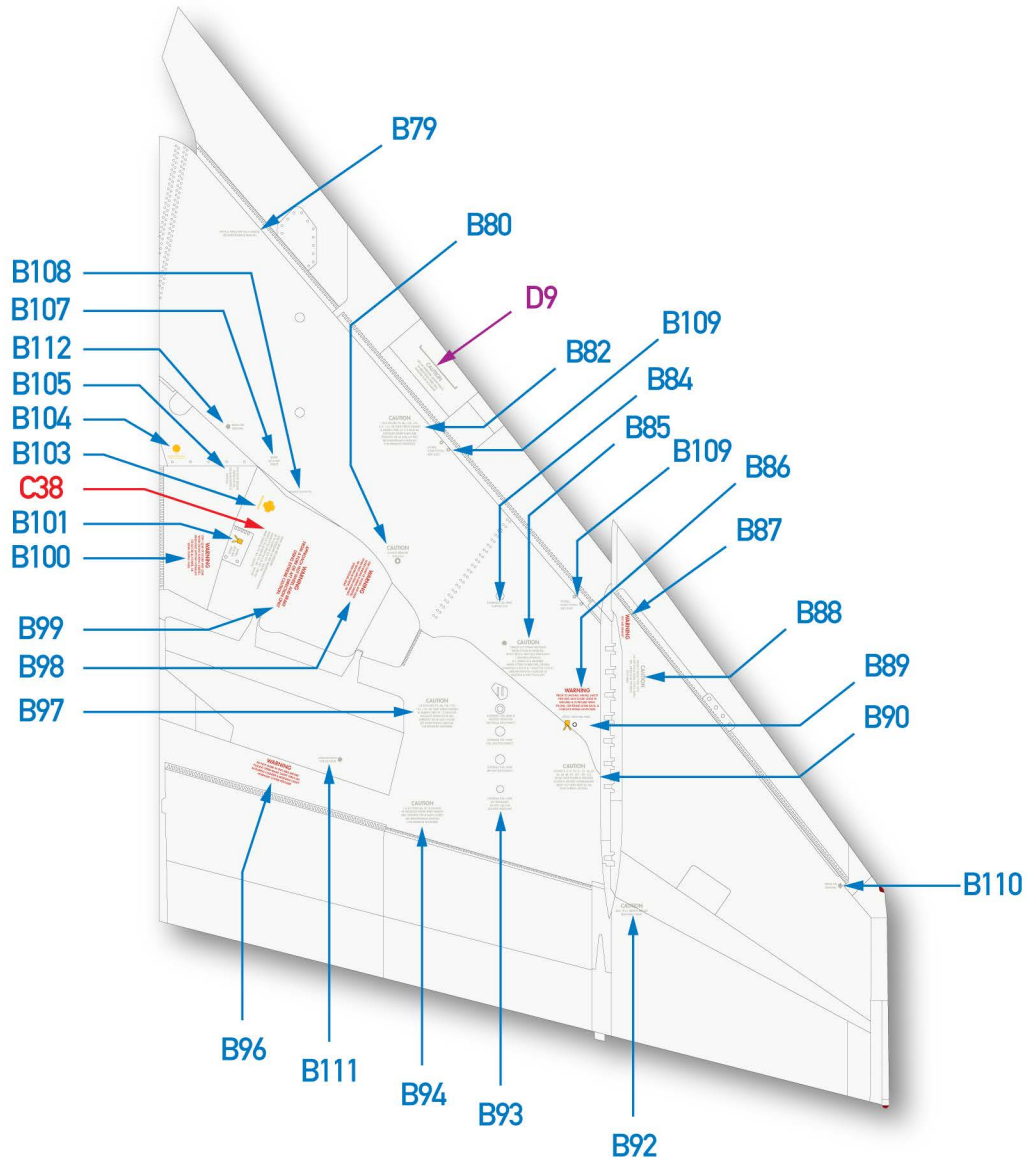

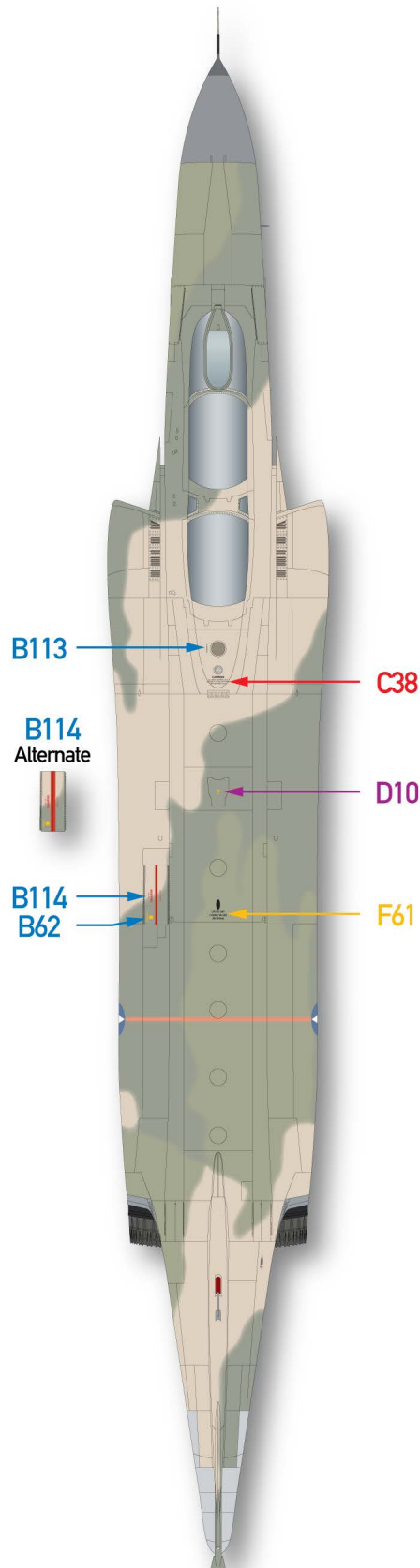

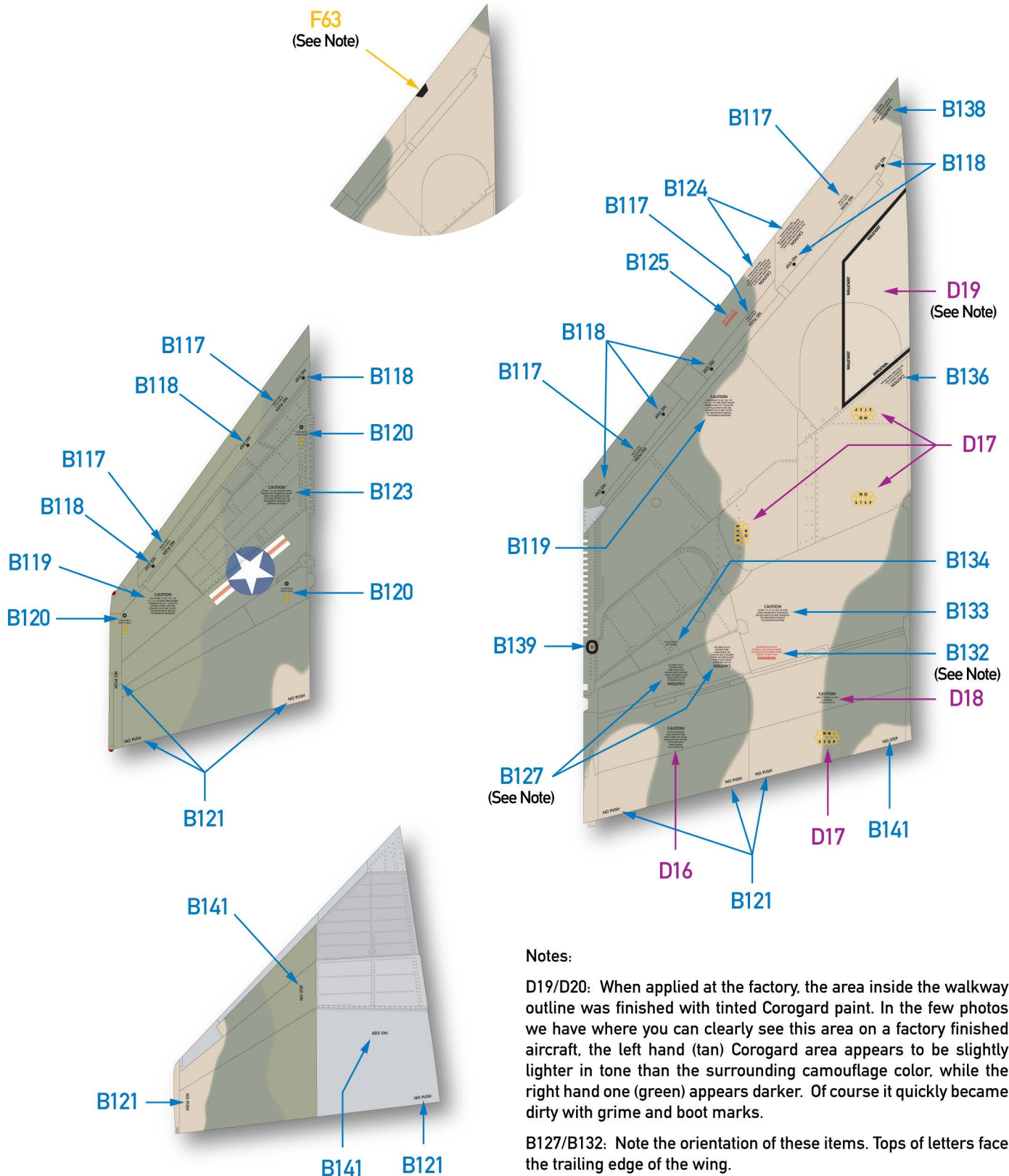

Notes:

D19/D20: When applied at the factory, the area inside the walkway outline was finished with tinted Corogard paint. In the few photos we have where you can clearly see this area on a factory finished aircraft, the left hand (tan) Corogard area appears to be slightly lighter in tone than the surrounding camouflage color, while the right hand one (green) appears darker. Of course it quickly became dirty with grime and boot marks.

B127/B132: Note the orientation of these items. Tops of letters face the trailing edge of the wing.

F63/F64: Note orientation of these items. Only found on hard wing RF-4E. Check photos of your subject aircraft.

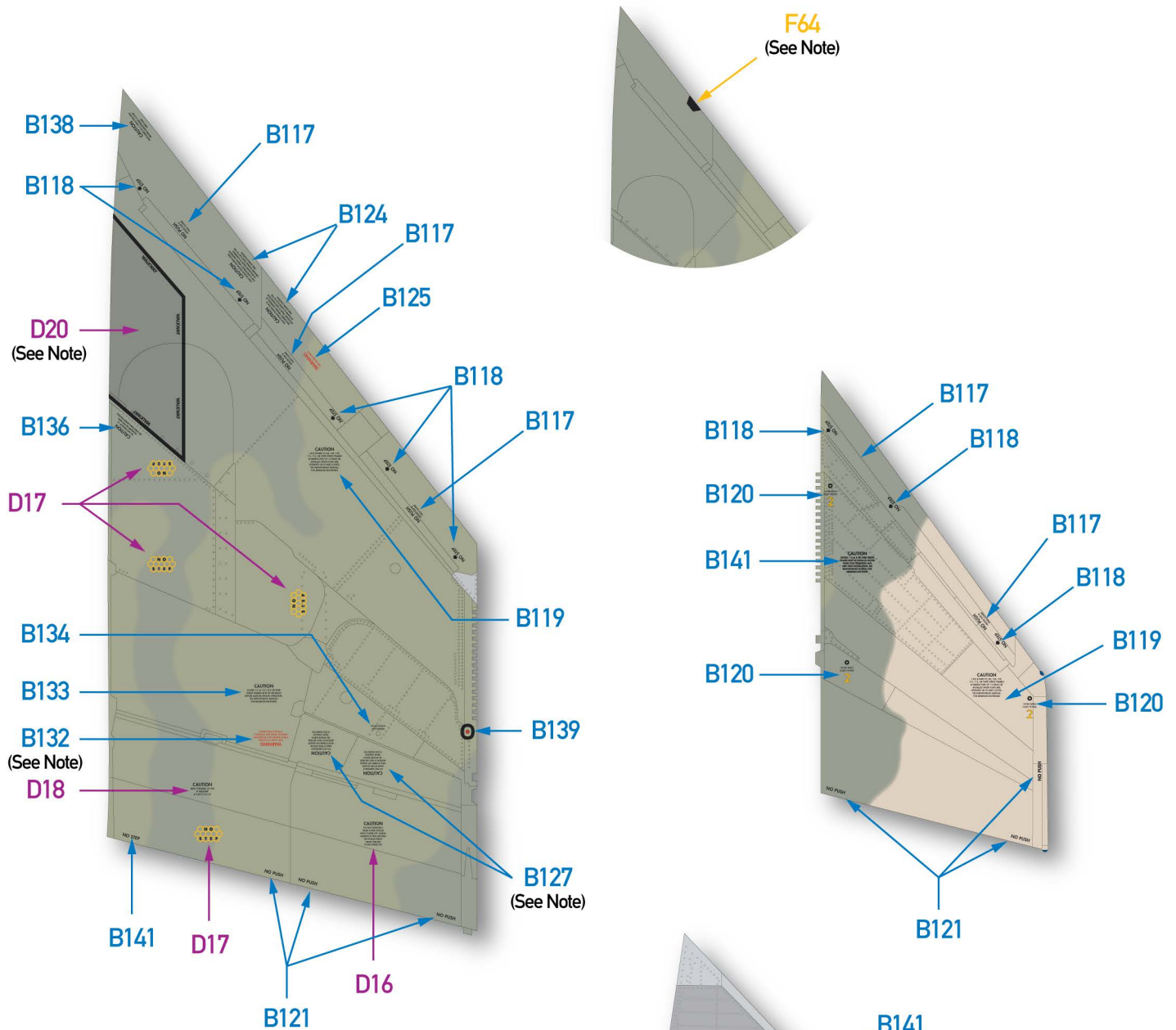

Notes:

D19/D20: When applied at the factory, the area inside the walkway outline was finished with tinted Corogard paint. In the few photos we have where you can clearly see this area on a factory finished aircraft, the left hand (tan) Corogard area appears to be slightly lighter in tone than the surrounding camouflage color, while the right hand one (green) appears darker. Of course it quickly became dirty with grime and boot marks.

B127/B132: Note the orientation of these items. Tops of letters face the trailing edge of the wing.

F63/F64: Note orientation of these items. Only found on hard wing RF-4E. Check photos of your subject aircraft.

F-4B, Early F-4C, F-4J, RF-4B/C Inboard Pylons

Left Inboard Pylon

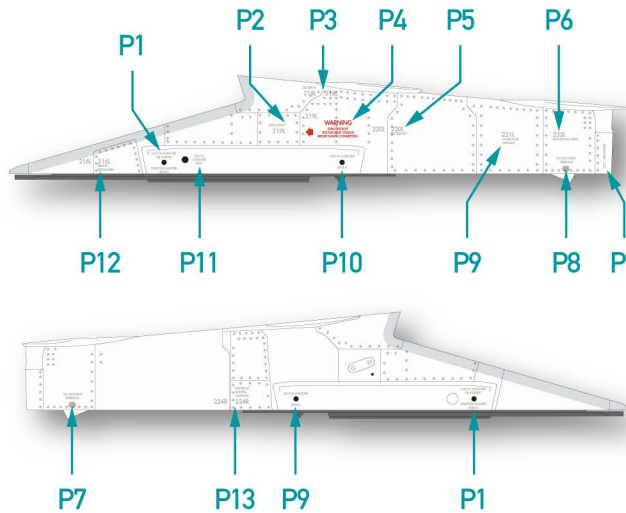

Right Inboard Pylon

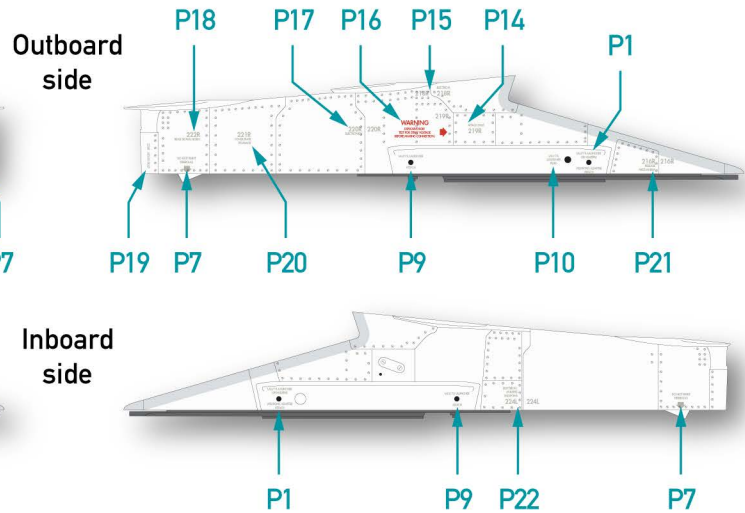

Late F-4C/D/E/RF-4E Inboard Pylons

Left Hand Pylon

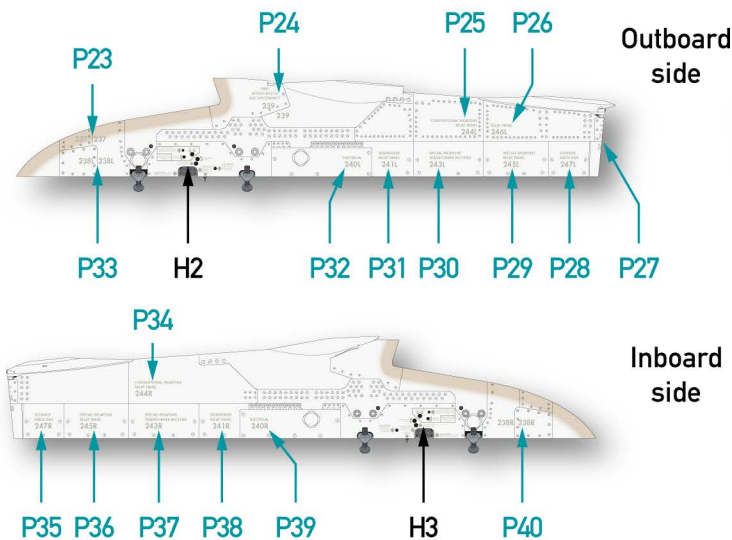

Right Hand Pylon

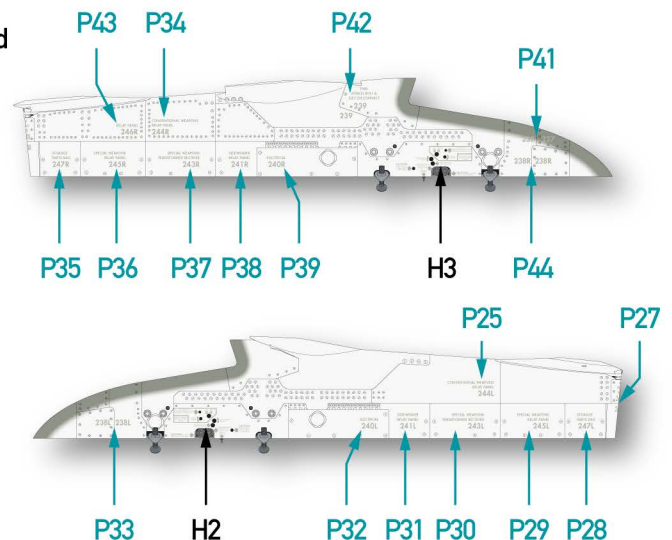

Sargent Fletcher 370 Gallon
Wing Tank Pylons

Left Hand Pylon

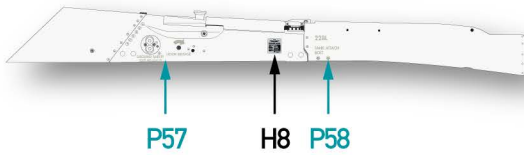

Outboard side

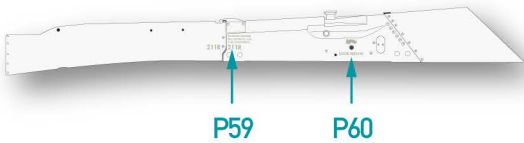

Inboard side

Right Hand Pylon

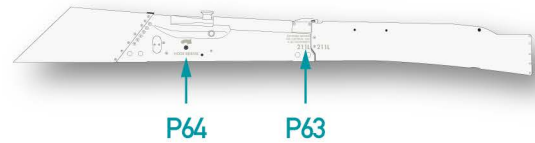
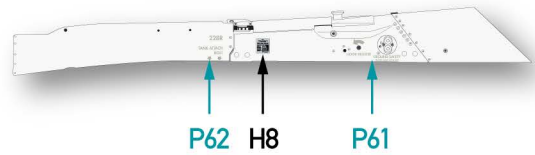

F-4C/D/E (USAF Type) Outboard Weapons Pylons

Left Hand Pylon

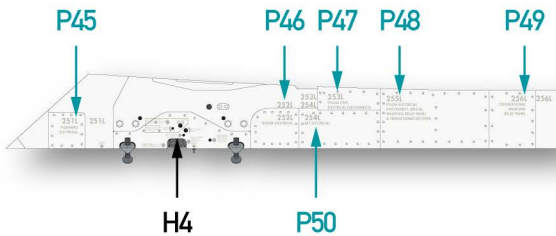

Outboard side

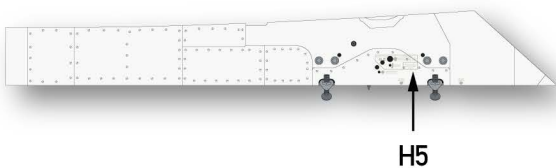

Right Hand Pylon

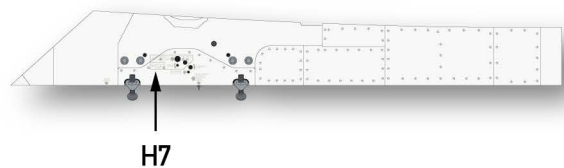
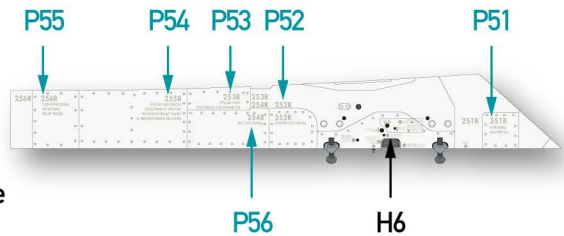

All F-4 Variants

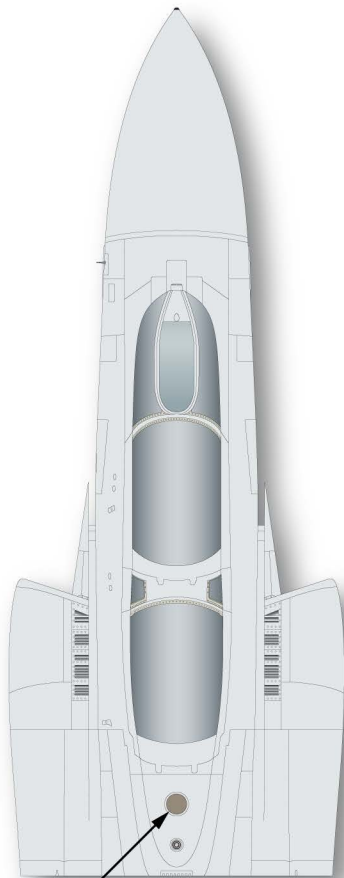

R5

Tamiya

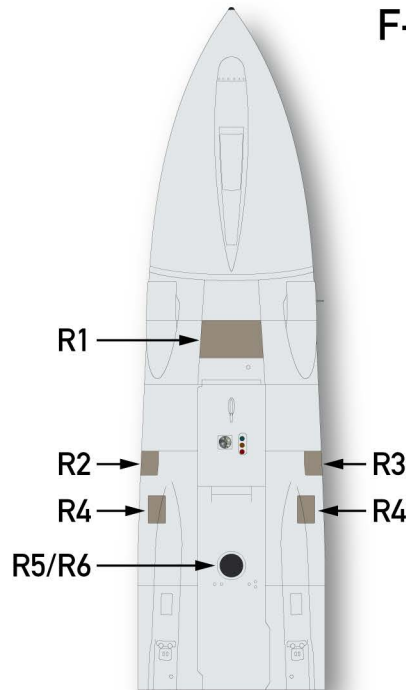

F-4B/C/D/J

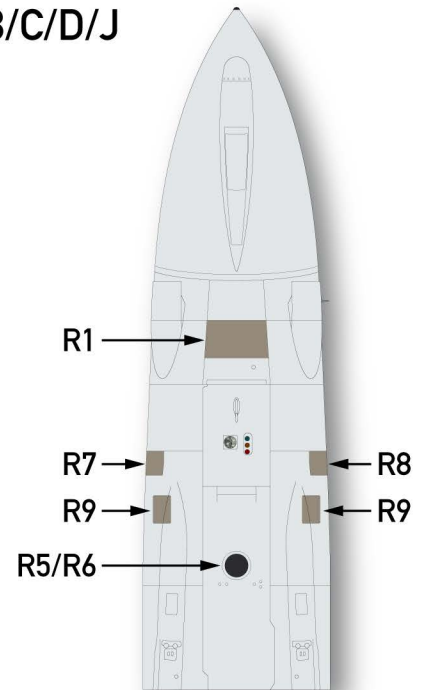

F-4C/D/E

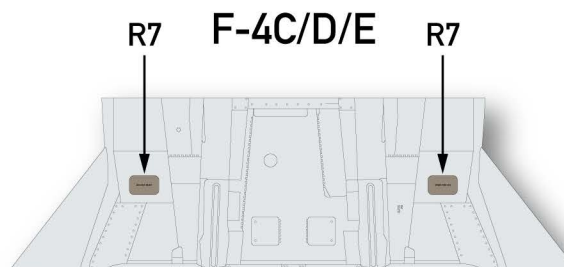

Zoukei-Mura F-4E

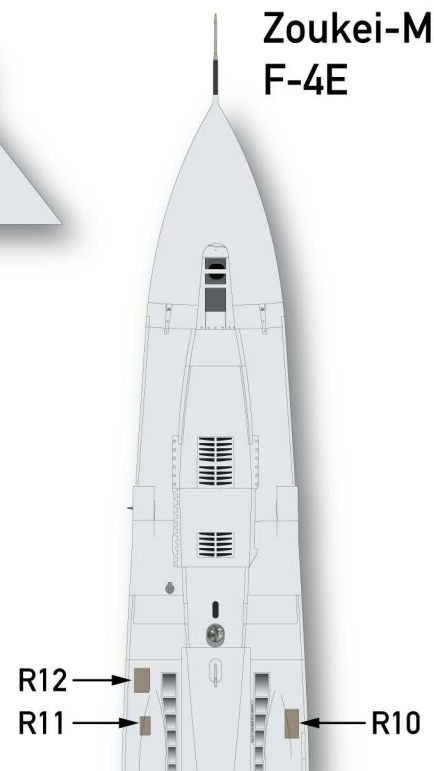

The F-4 family has a series of fiberglass dielectric panels at various places on the airframe. We have provided these as custom fit items for the Zoukei-Mura F-4C/D/J/S as well as for the Tamiya F-4B (and hopefully a future Tamiya F-4C/D and J!). You will notice the shapes are radically different on the ones under the nose for the B/C/D/J. Tamiya wins hands-down here, as theirs are almost perfect in shape and dimension compared to our tracings of the real thing. We recommend using decals R1-R6 on the ZM kit for better accuracy.

The round antenna panel on the nose gear doors of short nosed F-4s is generally very dark, so this is provided in black.

The panel where decal R1 goes was usually painted gloss white on Navy/Marine aircraft. Check photos to see if it is required for your subject aircraft.

F-4C/Ds and RF-4C/Es have radar altimeter panels under the wing roots, and these are provided from a tracing of the real panel for exact size and shape, which differ in size, shape, and orientation between the fighter and reconnaissance variants due to different systems being fitted..

The panels on the lower nose of the F-4E are quite different from those on the short nosed aircraft, and are asymmetrical, as correctly portrayed by Zoukei-Mura. All of these dielectric panels can be found in a staggering variety of colors, often quite weathered. We have provided three different shades so you can mix and match at will.

On "hard wing" F-4s (which includes the F-4B, C, D, RF-4B/C/E, F-4J, and F-4Es through 71-0236) the leading edge flaps featured Boundary Layer Control (BLC). This routed high pressure air from the engine compressors through ducts along the leading edges to "blow" the flaps and create greater lift, allowing a slower takeoff and landing speed. The BLC air exhausted through these two panels at the outboard end of the leading edge flaps. From the factory these panels were in their natural stainless steel finish, though on depot repaints they were often overpainted. Tamiya again wins hands-down for the shape and detail of this panel. The real thing is curved allowing for the air to escape, and you can actually put your hand into the opening (if you're not afraid of spiders and scorpions). Zoukei-Mura's panel is flat, just like the surrounding upper wing skin.

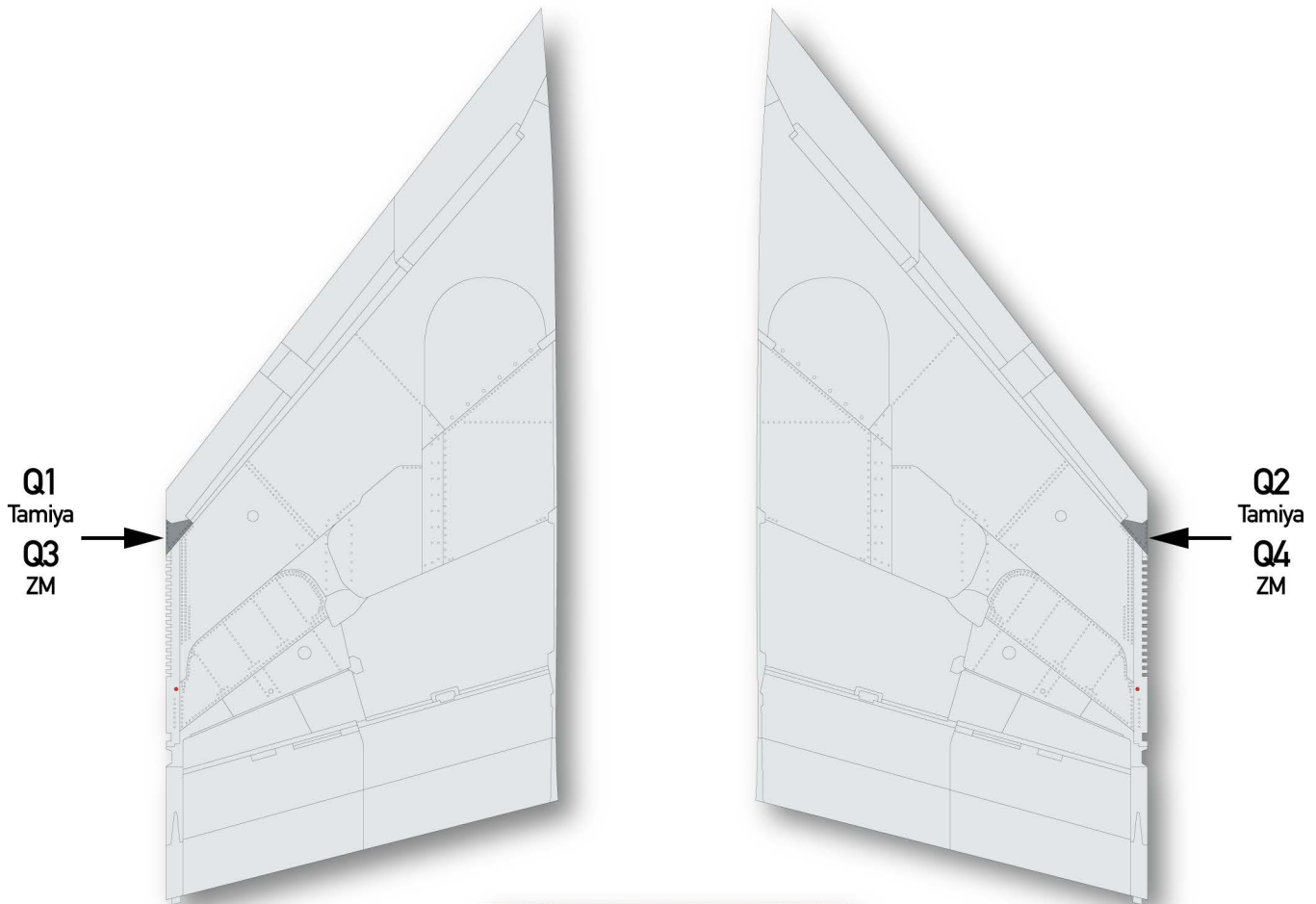

The left wing BLC exhaust on an RF-4C. This detail is identical on all hard wing F-4 variants (F-4B/C/D/early E/J/RF-4B/C/E).

As delivered new from the factory, all F-4 variants had some prominent raw fiberglass finished frames on the canopy (decals W1 through W9). In every case we have seen these frames were left in their natural buff colored fiberglass by the St. Louis paint shop, although on later depot repaints they are often overpainted with camouflage colors.

The decals have been custom fitted to the Tamiya F-4B (and the canopy parts it will share with the F-4C/D and J kits we sincerely hope are coming) and the Zoukei-Mura F-4C/D/E/EJ/J kits. Note the significant differences in the shapes. Proof that no matter how good a kit may look, no model kit is a miniaturized version of the real thing, it is an artistic representation at best.

We puzzled over how best to construct these decals. Since the inside of the canopy structure is finished in black to prevent glare for the crew, and since the buff colored decal visible on the outside, by necessity, has a white backing, we elected to provide identically shaped parts in both black and buff. In order to achieve the look required, and given the limitations of silkscreen printing, you will paint your model, masking the clear parts as usual. We recommend painting the canopy

frames black first, then apply your camouflage, allowing the black to show through on the inside. The same principle works for these fiberglass frames. Apply the black decals first, allow to dry thoroughly, then apply the buff colored items over the top.

Note that as accurate as it is overall, the Tamiya kit doesn't quite capture the exact shape of the center windows between the forward and aft canopies. We have provided parts to fit the Tamiya window exactly (W8L/R), as well as slightly narrower ones that match the real proportions of the window as we measured and traced it (W7L/R). The difference isn't huge, but once you notice it, it's there!

Decals W10 through W14 are the internal fiberglass sealant strips sometimes (but not always) visible. These are on the INSIDE of the canopy on the real aircraft, sandwiched between the frame and the plexiglass, but applying decals that way would be a real challenge... Just reverse the L and R decals if you want to try, and best of luck! We recommend cutting these decals into sections before applying them. There is plenty of extra black and buff colored striping to allow you to do any repairs necessary with any of these colors.

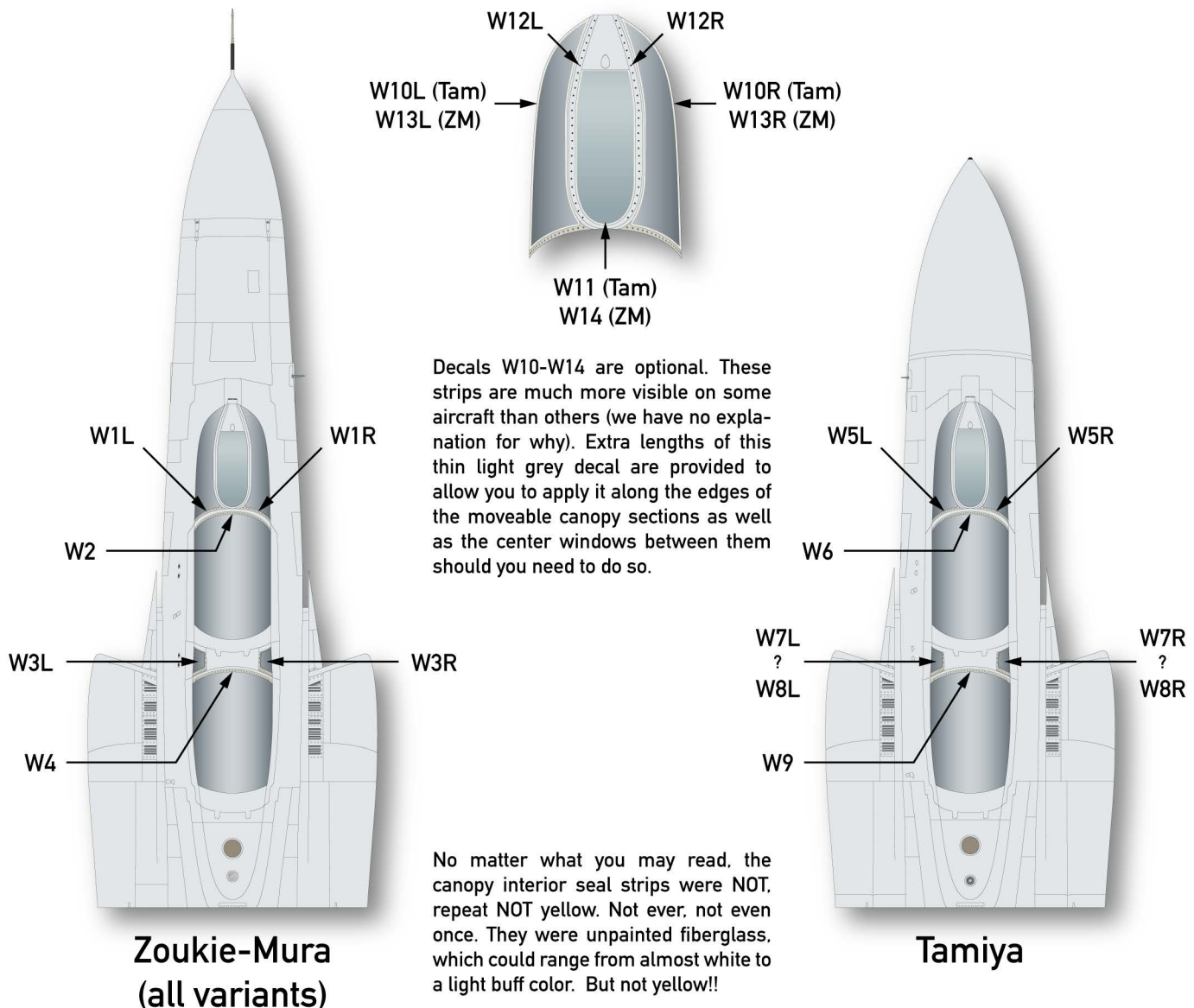



A collection of photos showing the raw fiberglass framing on the aft windscreen bow, the forward edges of the front and rear canopy, and around the center windows in the bow between the two canopies. Note that on the windscreen the fiberglass does not go all the way to the middle. It ends where the metal frame of the center panel joins. On some of these you can see the additional very narrow fiberglass that runs along the bottom and aft edges of the main canopies.



Right: A late find... A pristine F-4D with the more visible lower and aft edge internal fiberglass seal strips visible. These strips are on the inside of the plexiglass, though that is difficult to discern in most photos. This feature was seen on many, but far from all new F-4s. We do not know why that is the case, so the best we can offer is to look at photos of your subject and build what you see.



Nose Gear

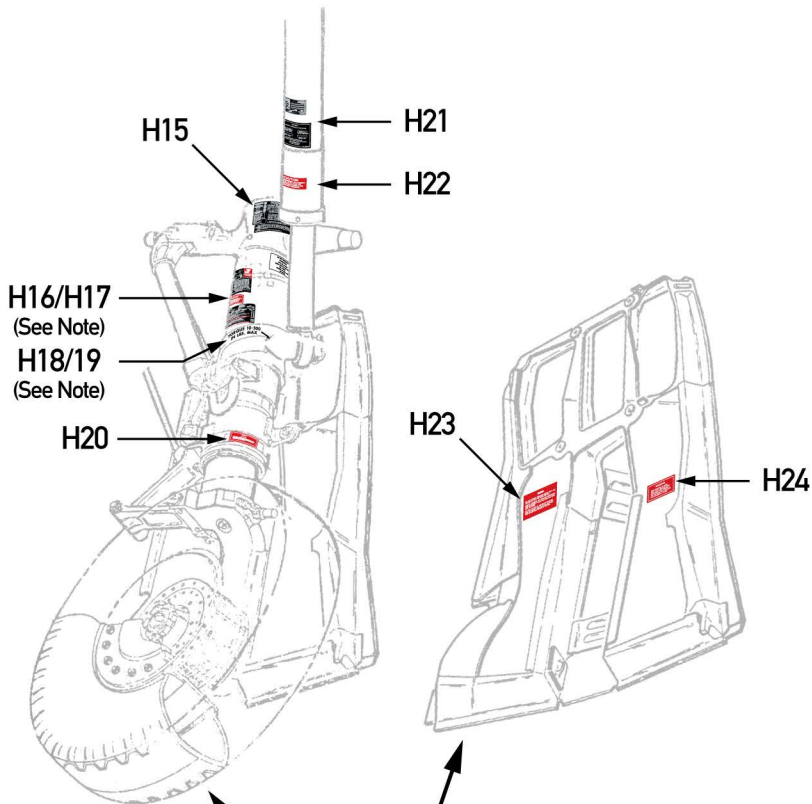
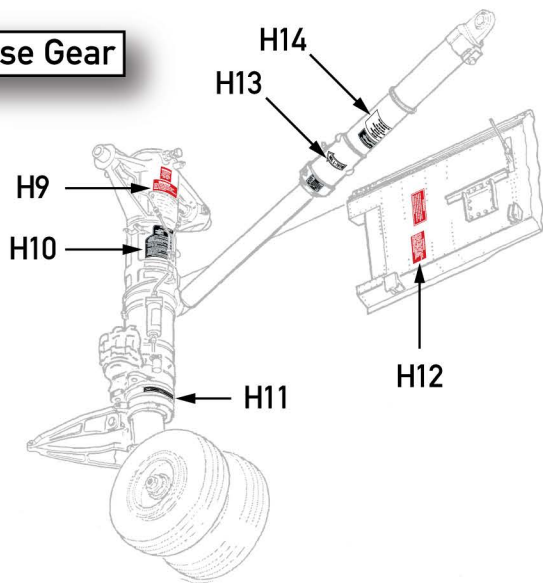

Inside of F-4C/D fwd nose gear door

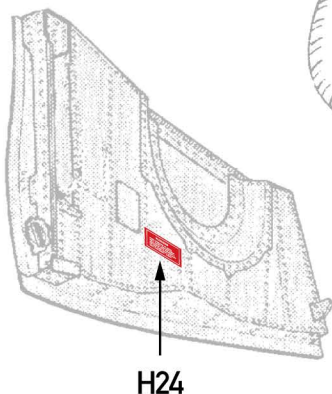

- Note -
Left Main Gear Shown
 H16 & H17 apply to left hand main gear strut.
 H18 & H19 apply to right hand gear strut. All other items are identical on both sides.

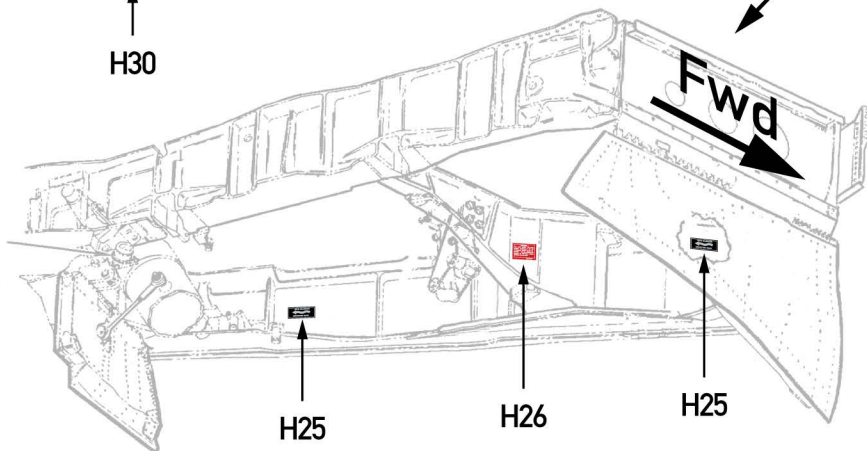

Inside of Speed Brakes

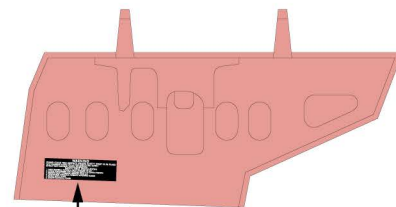

H27A/B
 (Black version is most common)



Here are two variations on the stencil data applied to the survival pack/seat cushion on the Martin Baker Mk.H7 seat as fitted to all F-4s after around 1967. The one good photo we have found of the earlier Mk.H5 seat shows very similar markings on the survival pack. These images show an Air Force style seat (above) and a Navy style seat (at right) with different variations of the stencil data, and there were others as well. You can cut the decal to match these or use as-is, as there seems to be very little standardization. Research on ejection seat details is a sorely lacking area in the scale modeling world - a situation that we hope will someday be rectified by some enterprising researcher/author.



Slime Lights

Flying high speed fighters in formation at night and/or bad weather is an inherently dangerous operation in the best of times. As a way to increase safety while at the same time not giving away the aircraft's position with bright or flashing lights, low intensity formation lighting was developed in the 1960s. This consisted of strips of electroluminescent lights applied to various places on the aircraft to provide cues to the position and distance of the aircraft from an observer. Universally known as "slime lights" because of their pale greenish-yellow color, these formation lights first appeared on production F-4s beginning with the F-4E-45-MC production block, serial number 69-7579. The USAF and most foreign users adopted them, with the notable exceptions of the RAF and Royal Navy, and (oddly) Germany's RF-4Es. The US Navy and Marines only adopted them much later, in the late 1970s, and no F-4B, RF-4B, or F-4J was ever fitted with them at the factory.

The USAF retrofitted its entire fleet of earlier F-4Cs, Ds, and Es and RF-4Cs with these lights during depot maintenance, with the entire fleet being outfitted by 1974. There were significant differences, particularly in the treatment of the lights on the wing tips, between factory fitted and depot upgrades (see following pages).

While this decal only covers McDonnell Douglas factory stencils, we decided to make an exception on the slime lights. Since we had done the research and were printing the required colors anyway, we've decided to provide as many depot style slime lights as we can identify from period photos.

F-4 fuselage and vertical tail slime lights are mounted in a frame that stands proud of the skin of the aircraft by about 1/8" (approximately 3-4 mm), held in place with Philips head screws.



On the wing tip lights on hard wing aircraft, the frame holding the electroluminescent strips was set into the skin panel on the tip, while on almost all depot mods we have found, it completely fills that skin panel (see diagrams), and often appears slightly raised above the wing skin. The design of the wing tip lights changed completely when the slatted wing was introduced on the assembly line starting with F-4E-48-MC 71-0237. It appears there was an early version, found on aircraft at least midway through the FY72 production blocks (see photo next page), and a later version fitted through the end of F-4 production.

On factory installed lights, the mid-fuselage strips in Access Doors 36L and 36R were invariably mounted at a slight nose-down angle. Depot installed lights in this location could be seen the same way, while others appear to be parallel to the lower edge of the panel.

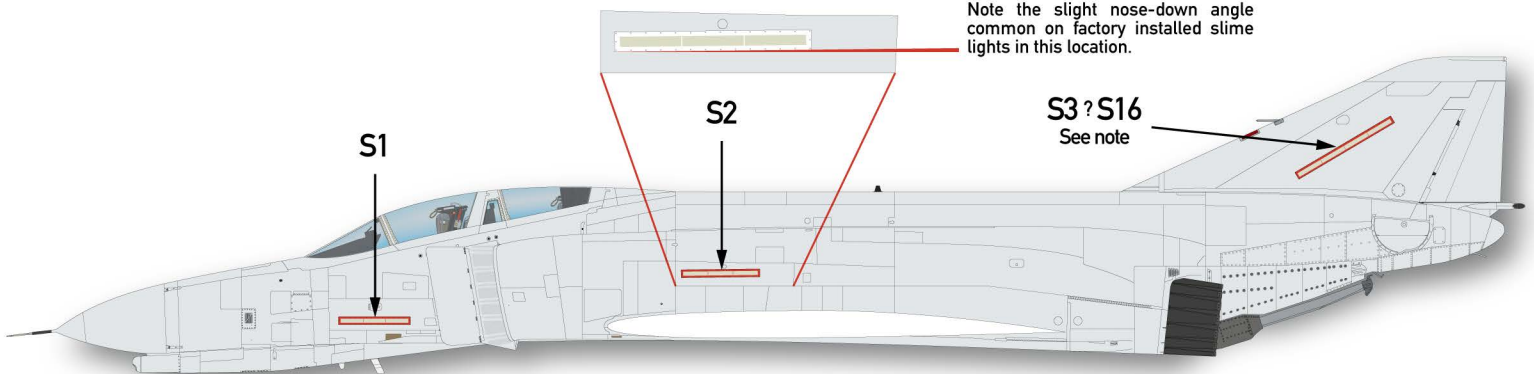

Left: the forward fuselage light on QF-4E-61-MC 74-1625 showing the slight raised frame.

Below: the center fuselage light on the same aircraft. Note the slight nose-down angle common on factory installed slime lights in this location.

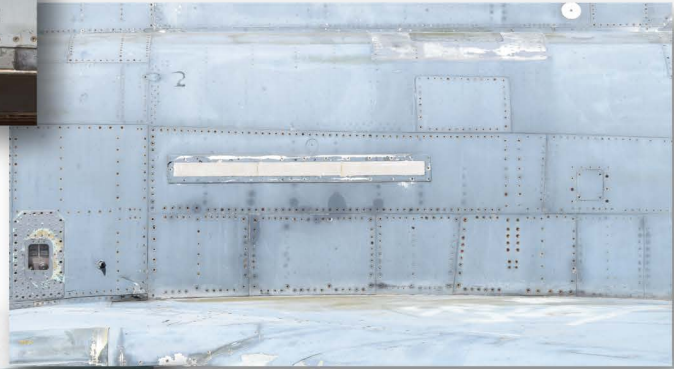

Note: Pending further research, it appears that on (at least) F-4Cs and Ds with depot installed slime lights, the four-light strip on the tail was shorter than the factory F-4E type decal (S16). The precise depot installed location and angle on the tail could also vary. Check your references carefully!



Left: the left wing tip light on F-4E-54-MC 72-1484 showing what we believe to be the early configuration of the slatted wing tip light. Note the brownish frame around the light.

Below: an F-4F (identical with later block F-4Es) showing the more common style of lights. This aircraft lacks the black frame seen on many aircraft.



Left: a shot of an IDF hard wing F-4E with the narrow black framing around the light strips. These were often seen mixed with unframed light strips on the tail on the depot installed lights.



**Factory Installed
Hard Wing Lights**
F-4E/RF-4C/E

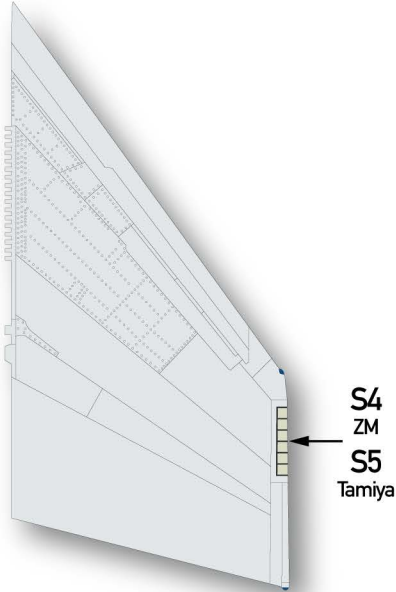

**Factory Installed
Slat Wing Lights**
F-4E

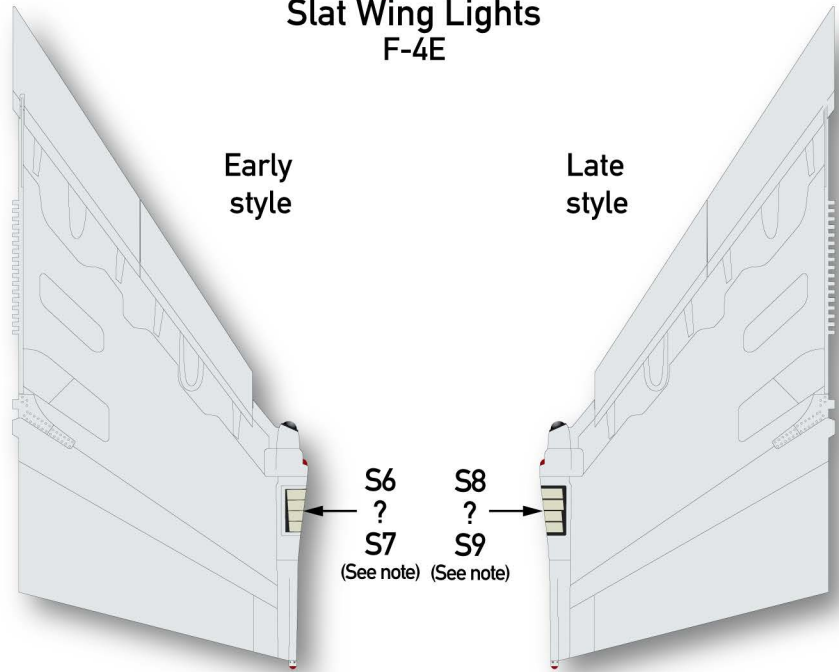

Factory lights ↑

Depot lights ↓

↑ **Factory lights**

↓ **Depot lights**

**Depot Installed
Hard Wing Lights**
F-4C/D/E/RF-4C

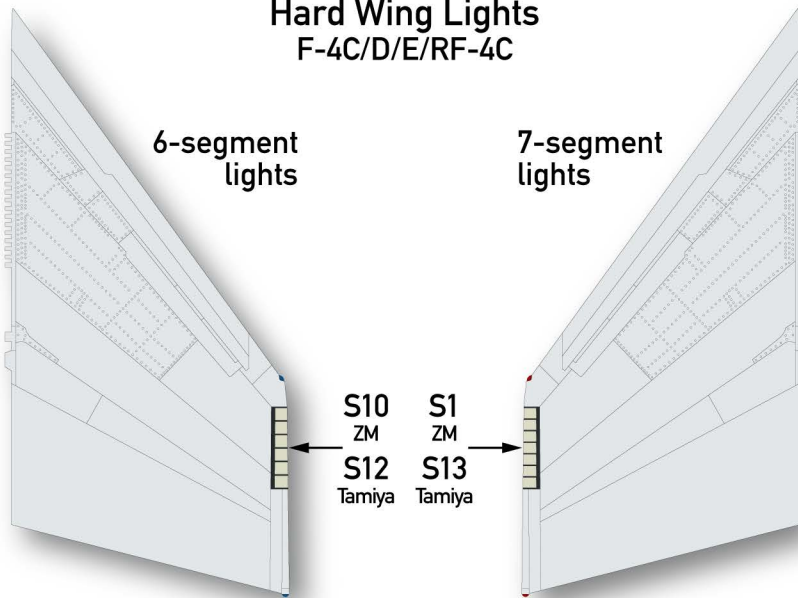

**Depot Installed
Slat Wing Lights**

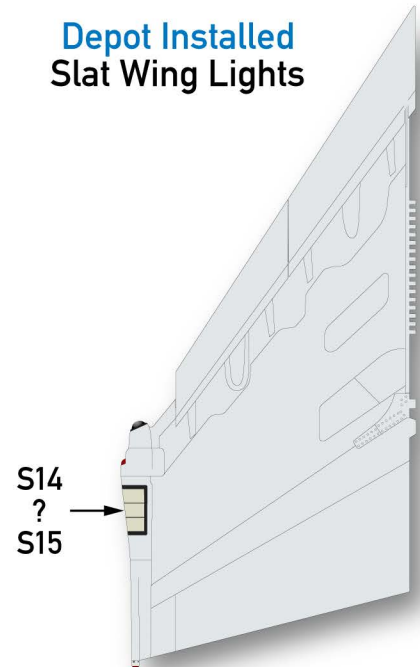

Note: Decals S6/S7 are the initial style of lights fitted to early factory slat-wing aircraft through at least sometime in the FY72 production blocks. Decals S8/S9 are the later style. Check photos of the specific aircraft you are modeling, but if in doubt use the more common later style.

Wing Tip Nav Lights

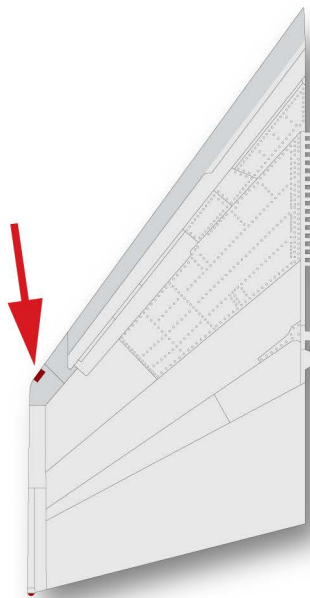

Phellow Phantomaniac Kim Simmelink (in his terrific Phantom Phacts blog; <https://phantomphacts.blogspot.com>) notes three distinct styles of Phantom wing tip lights. The first style (not shown here) seems only to have been fitted on the very earliest airframes before the second style (shown at left) appeared. This was found on F4H-1s as well as early F-4Cs. It appears the change to the 'bug eye' style lights took place somewhere during Block 6 production on the F4H-1, but the picture is still very muddy. Since the first actual F-4C was a Block 15 airframe, and we have photos of quite a few early F-4Cs with the original style flush light, we're at a loss to explain how it came down. What we do know is that the 'bug eye' style was pretty rapidly retrofitted, and the older flush style seems to have disappeared, even on test birds, by somewhere around the end of 1964. This feature is often virtually impossible to discern in photos, but we have provided some below to illustrate the original style. For sure the two F-110As (BuNos 149405 and '406) as well as a significant number of actual production F-4Cs had the early style when they rolled out of the factory. More reseach required!

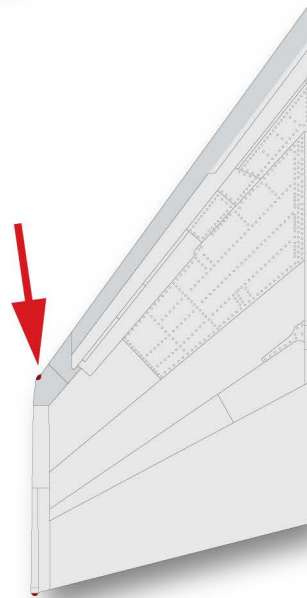

Left: F4H-1 149405 Block 9, alias F-110A is seen shortly after roll out in Jan 62. She has the original flush style nav lights.



Right: F-4C-15-MC 63-7410 showing the flush style lights.

Wing Tip Nav Lights



Above: F-4C-15-MC 63-7407 displays the flush style light shortly after roll out in Jul 63.



Above: We can't explain how F4H-1 149406 Block 9, here marked as the second F-110A prototype, got the later 'bug eye' lights as quickly as it did, but photos don't lie! This photo dates from the summer of 1962 during weapons compatibility testing.

Below: F-4C-15-MC 63-7408 photographed during 1965, now with the 'bug eye' style nav lights.



Below: F-4C-15-MC 63-7419, date unknown, also with the later style lights.



Total air temperature

In order to accurately display the airspeed and Mach number of a supersonic aircraft, it is fitted with a total air temperature (TAT) probe. High speed ram air is subject to a slight increase in temperature due to its being compressed by the speed of the aircraft. The purpose of the TAT is to sample this air, and bring it to zero relative motion with respect to the aircraft so that the compression heating effect can be eliminated, and the true temperature of the air assessed by the air data computer.

This is then used in calculating and displaying the true airspeed and Mach number in the cockpit.

On the first several hundred production F4H-1s and F-4Cs, the inlet for the TAT was mounted low on the leading edge of the vertical fin. This position was found to be less than ideal, so beginning with Block 16 production. (F-4B 151399 and F-4C 63-7421, delivered in late 1963), the TAT was moved to a small probe mounted just below the port side Environmental Control System inlet behind the radome. This position became standard on all short nose F-4 variants, and was present on all subsequent aircraft in that position. Earlier aircraft had the probe relocated to the nose position. Photos of early F-4Cs with the original TAT probe on the vertical fin are very rare, and it seems the change of location happened very quickly.

On the RF-4 the TAT probe was mounted on the forward nose gear door, and on the F-4E it was mounted to the right of the gun fairing forward of the nose gear door.

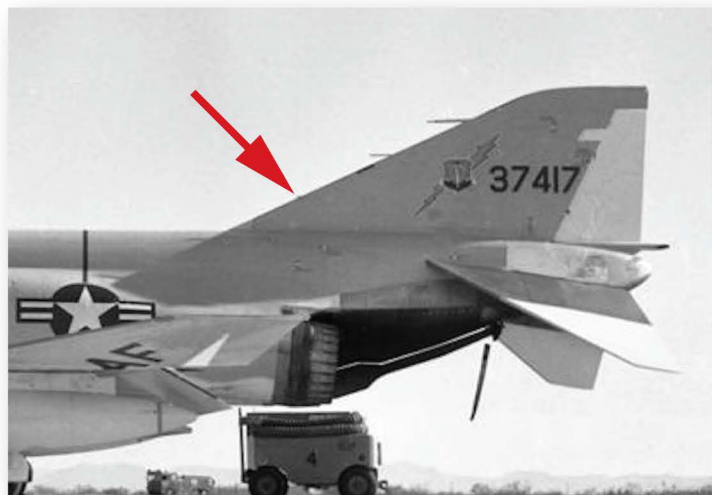
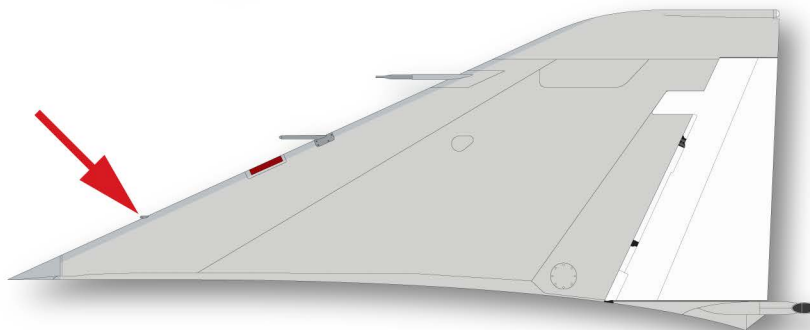

F-4C-15-MC 63-7417 which first flew on 27 Sep 63, still with the original style TAT fitted into the fin leading edge.



A retired F-4C showing the standard TAT probe position below the port ECS inlet fairing.

Engine Bay Access Doors

Another of the (many) things we learned as we dove deeper and deeper into the minutiae of Phantomania on this project was the differences in the panel lines and access doors in Navy vs. Air Force/export Phantoms. Because the two services had differing requirements, some of the ancillary equipment fitted into the engine bays, as well as the starting system for the engines, differed. This resulted in some fairly significant differences in the areas shaded in blue and red below. While it might not be that visible on your model, the differences are there, and will impact how the decals are applied. Tamiya and ZM both got it more or less correct, but other, older F-4 kits often completely miss these detail differences.

F-4B/J/RF-4B

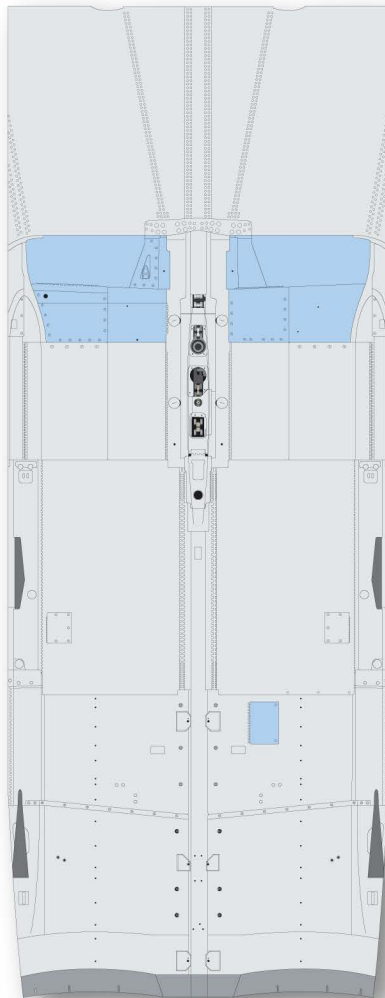

F-4C/D/E/RF-4C/E



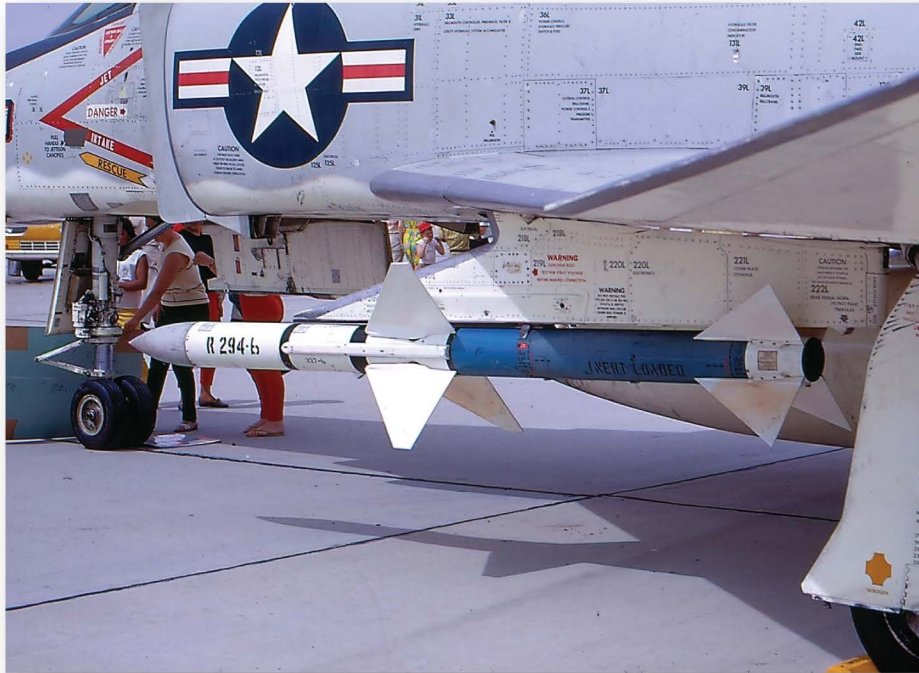

We have provided a selection of serial numbers so prominent on AIM-7 Sparrow missiles from the early 1960s to the early 1980s as seen loaded on Phantoms. There are several styles, and a range of serials from very low ones, into the 10,000s, covering most of the period when aircraft with their factory stencil data would have carried them. Above and below are photos showing the positioning of these serials. Check your references for the most appropriate serial range for your subject.



The Very, Very Last Page!

(For all the stuff that didn't fit anywhere else)

Some random thoughts on modeling F-4s - in no particular order:

- When looking at details of the early Mk.H5 and later Mk.H7 seats, note that the "H" is important. A Martin Baker Mk.5 is not the same seat as a Mk.H5 at all. Be sure you know what you're looking at.
- Things that droop as soon as the engines are powered down:
 - Ailerons - but not flaps - droop gradually. Only a little when the power is first turned off, then keep dropping for days if the engines aren't powered back on. So any variation in amount of droop is appropriate/realistic based on how long since power was removed.
 - Lower wing speed brakes - same principle as the ailerons.
 - Engine auxiliary intake doors (Doors 81R and 81L): fully open when engines are shut down. They close immediately and violently when power comes on (and will take your hand off it's in the way!)
 - Gun gas purge door (F-4E/F only, decal F62) fully opens immediately when power is removed and closes when power is applied to the aircraft. It opens in-flight when the gun is fired.
 - Drag chute hatch door/tail cone is generally open after landing and parking (assuming aircrew used the drag chute on landing, which was normal ops). It would normally stay open until the crew chief packed a new chute for the next flight.
- Canopies were normally seen either fully open or fully closed. Yes, the aircrew could stop the canopy at any point in between, but photos of them in an in-between position are vanishingly rare. If you see a photo of an F-4 with one or both canopies in a partially open position, it is almost assuredly an "action" photograph, where the canopy was actually moving to the full open or full closed position at the exact moment the photographer tripped the shutter. Based on photographic measurements, a typical fully open position is approximately 40-42 degrees from the static ground line, or 52-54 degrees from the canopy sill.
- Wheels/tires: USAF style main gear brake assemblies in the center of the hub were a rusty steel color, often with dark grey/black residue. Navy/Marine aircraft had a different hub/brake assembly. Tires inflated normally had very small flat spots but did not bulge. They were high pressure tires with very strong side walls.
- Weathering the undersides: Phantoms were generally very clean forward of the line defined by the main wing spar. Behind that they were filthy along the panels under the engines (but not the intakes forward of the engine bays) and the wings were lightly to medium dirty around the wheel wells and behind the speed brakes and flight controls (flaps, ailerons and spoilers on top).



- The natural metal area behind the engines on Vietnam through 80s era Phantoms was *filthy*, with a heavy buildup of black and brown toned oily soot. It was not until the "smokeless" engines appeared in the 1980s that this changed. Most scale models don't portray just how dirty Phantoms were in those days, so for it with the soot! For 1990s and later (i.e., modern Greek jets) go nuts with the metallurgy experiments in different burnt titanium colors, after cleaner



“smokeless” engines were fielded in the late 80s, but a 60s or 70s jet is DIRTY. The concrete in the last chance pit at Udorn RTAB proves it!

- If you're depicting an F-4 powered up and taxiing out for a strike, then all those ailerons, speed brakes, engine aux doors, and gun gas purge door (on F-4Es) should be up/closed/tight while engines are running. Drooping ailerons and/or speed brakes on a jet in EOR arming pit is something you just wouldn't see in the real world.
- Other mentionable factoids:
 - Almost never during the Vietnam War, did a USAF F-4 have any combination of bombs, missiles, or rockets on the inboard pylons while also having AIM-9s on that same pylon. Until the Sidewinder launcher spacers (demanded by Robin Olds) became available it was physically impossible to mouth both on the same pylon.
 - The same holds true for the Navy & Marines until roughly Linebacker and Linebacker 2 in 1972.
 - USAF F-4Ds and some early Es did mix one AIM-4 Falcon missile with some combination of bomb/bombs on the inboard pylons, but the Falcon didn't last long in Southeast Asia. Copy your references for these configurations closely (and also provide copies of those photos to the IPMS judging committee if you're entering a model contest).
 - You can find photos of late Navy jets with 2x AIM-9s and a TER full of Mk 82s, but this configuration is unlikely to have happened more than a handful of times during the late stages of the war, and did not happen at all during the early cruises of the Rolling Thunder campaign, as, again, it was physically impossible before the AIM-9 rail spacers.
 - Normal position for the horizontal stabs is with the leading edge a few degrees higher than the trailing edge. This slightly aircraft nose-down position was a standard trim setting for ground ops and parking. Occasionally you'll see a photo with the stabs in a dead neutral (straight/level attitude), and even more rarely you might see the stabs at angled leading edge down, however this is really only seen on powered aircraft about to launch.

The End!!

(See, that wasn't so bad, was it?)

And just because...



*they don't come any
prettier than this...*

THANKS TO PHELLOW PHANTOM PHANATICS SCOTT WILSON, KIM SIMMELINK, JEFFREY KUBIAK, PETER GREENGRASS, JUN TEMMA, ANDREAS KLEIN, BRIAN NICKLAS, FOTIOS ROUCH, HENK SCHUITIMAKER, DON GILHAM, JERRY HUGHES, GEORGE CANCIANI, ROB MARTARE, CLINT ROWLAND, MARK RICHARDSON, HENK SCHAKELAAR, ES-HAQ KHOSRAVI, BEHNAM BAHRAMI, TOM NEAL, TOMMY THOMASON, AND YOSI YAARI FOR THEIR INCREDIBLY KIND AND GENEROUS ASSISTANCE ON THIS PROJECT...

AND A MOST HEARTY AND VERY SPECIAL THANKS TO MY GOOD PHRIEND CHRIS MAYER, WHO SUFFERED THROUGH MY ENDLESS TEXTS AND EMAILS OBSESSING OVER THE MOST ARCANE OF PHANTOM DETAILS, AND WHO ALWAYS CAME UP WITH THE MOST AMAZING PHOTOS OF EXACTLY WHAT I WAS LOOKING FOR.

WITHOUT HIM, THIS PROJECT, TO PUT IT QUITE SIMPLY, COULD NOT HAVE HAPPENED!

SPOOK ON GUYS!